Up and Running: A REAPER User Guide v 5.24

Version 5.24
August 2016

This guide will be updated regularly as the software itself is further improved and developed.
Check for updates and other information at
<http://www.cockos.com/reaper/>

This document has been produced, compiled and rendered to PDF format using the
wonderful **LibreOffice Writer** software.

For more information about **LibreOffice** go to <http://www.libreoffice.org>

How to Use This Guide

REAPER is a sophisticated program and there is no single obvious or easy way or order to present all of the information contained in this guide. If you need more information about any topic than appears on any particular page, try searching! The PDF edition is bookmarked, and your PDF reader includes a *Find* feature on its toolbar. Also, both the PDF and printed editions feature a comprehensive index. Use it!

For a bound printed hard copy of this User Guide go to LULU.com

ReaRead: REAPER books and training manuals printed and bound are now available from <http://stores.lulu.com/spotlight/glazfolk>

REAPER 4 Unleashed: Unlock Your Inner REAPER!

"REAPER Unleashed" picks up where "Up and Running" leaves off.

This book lifts the lid off REAPER's most powerful features, including custom actions, menus and toolbars, FX chains, screensets, snapshots, templates, mouse modifiers and more. Many resources are supplied, including files with sample mouse modifiers, track templates, custom toolbars and much more.

Its sample work files and dozens of step by step tutorials will help you to understand how you can use these features in combination with each other to make REAPER behave for you the way you want it to.

Will it teach you everything that you could possibly ever want to know about REAPER? Most definitely not. But will it help you unlock the creativity inside you to help you get the very best out of this program for yourself? Most certainly, yes!

Up and Running: A REAPER User Guide

The essential and definitive guide to recording, editing and mixing with REAPER. Fully updated for each dot version. Includes sample project files and step by step examples to help you learn how to use the many features of REAPER.

Includes special sections on key REAPER features such as routing and audio channel splitting, as well as numerous examples of how to use and apply many of the supplied FX plug-ins.

"*Up and Running* is not only a comprehensive guide to using REAPER, it's also full of an amazing amount of information on audio recording and engineering. I simply cannot recommend it enough!" - **Justin Frankel** (COCKOS Inc and REAPER Developer).

ReaMix: Breaking the Barriers with REAPER

This book does much more than just teach you how to use basic tools (such as volume, panning, EQ, gates, compressors, delay, reverb etc.) to get an OK mix. It also guides you thru the relationships – some simple, some complex – that exist between the dimensions of sound and the dimensions of space. It guides you to use this knowledge to transform your OK mixes into great mixes.

Although not light on theory, it has a definite practical emphasis, with links to archives containing some 40 or so project files, with step by step examples to help you put your knowledge into practice.

"Wow! So much good stuff - from mindbending advanced techniques to solid sensible advice. This guide should have a positive effect on just about anybody interested in mixing (and especially those using REAPER)!" - **Justin Frankel**, Cockos Inc, developer of REAPER.

Foreword and Acknowledgements

REAPER isn't just about software, and it isn't just about making music. It's about a whole lot more. REAPER is a whole entity. It represents the way music should be, the way the internet should be, the way computers should be, the way program development and licensing should be in fact, the way the world should be. It's about collaboration and co-operation, and it is truly awesome.

This User Guide could not have been produced without the help of many in the REAPER community, and especially:

Malcolm Jacobson for his efforts in getting together the first REAPER manual. **Art Evans** for his technical advice and constructive input.

Mario Bianchi (aka **Mabian**) for his help with document formatting and layout and for his constructive suggestions and ideas. Also, a special "thank you" for comprehensively checking the document.

Simon Mullings for his suggestions and the patient hours spent on the tedious job of proof-reading.

Darkstar and **musicbynumbers** for too many helpful suggestions to mention!!

Bevan Fowke (aka **Bevo**) for his advice and assistance with custom actions and macros.

Susan G and **Nathan** (aka **planetnine**) for their assistance and advice, especially (but not exclusively) on MIDI and especially notation editor matters.

Jason Brian Merrill for, amongst other things, review and comments.

Pipeline Audio for the original video tutorials. **Xenakios**, **Jeffos** and **SWS** for their extension sets.

And, of course ... **Justin**, **Christophe**, **Schwa** and **Jeffos**, for bringing us REAPER

So welcome to REAPER! This User Guide is intended to get you up and running in REAPER, and to help you understand better how the program works, so that ultimately you will better be able to help yourself.

If you are new to the world of digital audio, you'll find that there is more than enough information in here to get you "up and running". You'll probably find that some sections contain information that you'll find difficult to understand and which you might not need at first. You can just skip over those sections and come back to them when you're ready. If, like me, you have come to REAPER with experience of other DAW software, you'll find that it pays to go over even the most basic sections, to help you understand how REAPER is designed, and how it slots together. You'll find yourself asking, "Why can't they all be like this?" You should also find plenty more to interest you.

It is not intended to be (and nor will it ever be) a 100% reference manual covering every single aspect and detail of REAPER. I've tried to approach the topics in what seems a fairly sensible order, introducing items pretty much on a "need to know" basis. In doing so, I've been as careful as I can be to ensure its contents are clear and accurate, but cannot accept any responsibility for any errors or problems you may encounter in applying it to your work.

REAPER Web Resources

The REAPER project is a live, dynamic and ongoing one. Be sure to check these web sites often:

http://www.cockos.com/reaper/	The REAPER Home Page
http://www.cockos.com/reaper/download.php	The REAPER Downloads Page
http://www.cockos.com/reaper/about.php	REAPER Features summary
http://www.cockos.com/forum/forumdisplay.php?f=20	The REAPER Forums
http://www.cockos.com/wiki/	The REAPER Wiki

Sample Project Files

These are available for download from http://www.cockos.com/wiki/index.php/REAPER_User_Guide

Note that the links are case sensitive. The media files are in .MP3 format. Some of the examples outlined in this book require recording further tracks in MP3 format. In order to be able to do this, you will need to have an MP3 encoder installed in your REAPER program directory. The encoder file can be downloaded from a number of locations, including http://www.free-codecs.com/download/Lame_Encoder.htm

Be sure to select the correct file for your system. For example, for 32 bit Windows this will be **lame_enc.dll**. After downloading the file, simply copy it into your REAPER program folder. Start REAPER, then open the sample project file and play it. If you hear no sound, you should check the routing settings for your Master Track and make sure that output is correctly directed to your sound device.

Up and Running: A REAPER User Guide v 5.24

What's New In This Edition

The table below summarizes the *main* feature changes introduced in REAPER 5.24.

It may also include some existing features that were previously not documented. The previous update before this was 5.23.

In addition to these, there are various bug fixes and performance enhancements. For a comprehensive list of all changes, choose **Help, Changelog** from REAPER's main menu bar, or choose **Options, Show REAPER resource path...** and double-click on the file **whatsnew.txt** to open it.

Changes in 5.24	Where ...
Dynamic split: New option to Add transient guide markers to items.	Page 152
Stretch markers: Options added for transient guides.	Page 184
MIDI Editor: Toggle filter checkbox added next to channel dropdown.	Page 230
Notation editor: Tuplets can now be assigned to a specific voice.	Page 278
Render dialog box: Any default directory setting is no longer displayed.	Page 404
Envelope toolbar: More options for when to add edge points.	Page 366
Preferences, Envelope Display: More options for when to add edge points.	Page 429

Note: With REAPER's rapid rate of development, this edition may not be 100% up to date. For a full list of new and recent features, choose the **Help, Changelog** command from the REAPER menu. To check for the latest versions of both REAPER and this User Guide, go to <http://www.cockos.com/reaper/download.php>

Contents

1 Setting Up and Getting Started.....	19
1.1 Downloading REAPER.....	19
1.2 Installing REAPER on an OS X Mac.....	19
1.3 Installing REAPER on a Windows PC.....	19
1.4 The Install Options (Windows only).....	20
1.5 Enabling MP3 Recording.....	20
1.6 REAPER Software Updates.....	21
1.7 Starting REAPER.....	21
1.8 REAPER Startup Tips.....	21
1.9 REAPER Selections, Controls and Commands.....	21
1.10 The REAPER Screen.....	22
1.11 The Track and Track Controls.....	23
1.12 Setting Up For Audio	23
1.12.1 Setting Up For Audio (PC Windows).....	24
1.12.2 Setting Up For Audio (Mac OS X).....	24
1.13 Input Aliasing.....	25
1.14 Output Aliasing.....	25
1.15 Setting Up For MIDI.....	26
1.16 Enabling VST Plug-ins.....	27
1.17 REAPER's Installed Folders and File Location.....	28
1.18 Localization and Language Packs.....	30
1.19 Backing Up Settings.....	30
1.20 Running REAPER on a Flash Drive.....	30
1.21 REAPER Start Menu Options (Windows only).....	31
1.22 REAPER File Types.....	32
1.23 Pops and Clicks.....	32
1.24 Uninstalling REAPER.....	32
2 REAPER Project Basics.....	33
2.1 Section Overview.....	33
2.2 Opening an Existing Project.....	33
2.3 Project Settings.....	34
2.4 Directing Audio Output.....	35
2.5 The Transport Bar.....	36
2.6 The Big Clock.....	37
2.7 Track Controls.....	37
2.8 Pan Law and Pan Mode.....	38
2.9 Navigation and Zooming.....	38
2.10 Keyboard Shortcut and Mouse Defaults.....	39
2.11 Using the Navigator.....	40
2.12 Track FX Basics.....	40
2.13 Using the Supplied FX Presets.....	41
2.14 Controlling Track FX.....	42
2.15 Creating a Default FX Chain.....	43
2.16 Using an FX Bus.....	44
2.17 Analyzing FX Performance.....	46
2.18 Selections and Loops.....	47
2.19 Managing Time and Loop Selections.....	48
2.20 Navigating by Jumping.....	49
2.21 Time and Loop Selections and the Transport Bar.....	49
2.22 Item Names, Buttons and Icons.....	50
2.23 REAPER Routing Essentials.....	50
2.24 The Routing Matrix.....	51

Up and Running: A REAPER User Guide v 5.24

2.25 Docking and Floating.....	52
2.26 The Undo History Window.....	53
2.27 Keeping a Window on Top.....	53
2.28 Multiple Project Tabs.....	54
2.29 Opening Multiple Project Tabs Together.....	54
2.30 Managing the Play Cursor.....	54
3 Recording Audio and MIDI.....	55
3.1 Creating a New Project.....	55
3.2 Setting Media Project Options.....	56
3.3 Saving the Project File.....	56
3.4 Creating and Naming Tracks.....	57
3.5 To Prepare and Record One Track.....	57
3.6 To Prepare and Record Multiple Tracks.....	58
3.7 Auto Arming Tracks.....	59
3.8 Using the Metronome.....	59
3.9 Recording Stereo Tracks.....	60
3.10 Multi-Channel Recording.....	60
3.11 Track Templates.....	61
3.12 Importing an Existing Project.....	61
3.13 Project Templates.....	61
3.14 Layered Recording.....	62
3.15 Overdubbing and Punch Recording.....	63
3.16 Non-Destructive Punch Recording.....	63
3.17 Destructive Punch Recording.....	64
3.18 Fades and Crossfades.....	64
3.19 Recording Multiple Takes.....	64
3.20 Showing Takes in Lanes.....	65
3.21 Using Color Coded Takes.....	65
3.22 Working With Multiple Takes.....	66
3.23 Overlapping Items.....	66
3.24 Recording Multiple Additional Items.....	67
3.25 Recording with Empty Events.....	67
3.26 Recording with Input FX Plug-ins.....	68
3.27 Preserve PDC Delayed Monitoring in Recorded Items.....	68
3.28 Recording a Track's Output.....	69
3.29 Recording FX Bus Output.....	69
3.30 Recording MIDI.....	69
3.31 Other MIDI Recording Modes.....	71
3.32 Recording With a Virtual Instrument.....	71
3.33 Using Microsoft GS Wavetable SW Synth.....	72
3.34 Looped Overdubbing and Looped Time Selection Recording.....	72
3.35 Recording with External Hardware FX.....	73
3.36 Preference Settings for Recording.....	74
3.37 Track Preferences for Recording.....	75
3.38 Projects with Mixed Formats.....	75
3.39 REAPER Audio Recording Checklist.....	76
3.40 Recording MIDI From Keyboard Check-List.....	76
3.41 Recording an Internet Audio Stream.....	77
3.42 Converting Audio Media Item Format.....	77
3.43 Recording Live Windows Output.....	78
4 Importing Media: The Media Explorer.....	79
4.1 Introduction and Overview.....	79
4.2 Searching the Media Explorer.....	80
4.3 Media Item Preview.....	80

4.4	Inserting an Audio File as a New Take or Item.....	81
4.5	Creating and Using a Media Explorer Database.....	82
4.6	Replacing an Item's Source Media.....	83
4.7	Importing MIDI Files.....	84
4.8	Importing Multichannel Audio Files.....	86
4.9	Import Formats.....	86
4.10	Importing Media from Audio CD.....	86
5	Project Arrangement Basics.....	87
5.1	Managing Tracks.....	87
5.2	Track Control Modifiers.....	88
5.3	Solo In Front.....	89
5.4	Auto-Naming Multiple Tracks.....	89
5.5	Searching the Preferences Settings.....	89
5.6	Track Colors.....	90
5.7	Color Themes.....	91
5.8	Track Icons.....	91
5.9	Track Layouts.....	92
5.10	Headphone Monitoring.....	92
5.11	Creating a Headphone Mix.....	93
5.12	Displaying Grid Lines.....	94
5.13	Understanding Sends, Buses, Submixes and Folders.....	95
5.14	Track Folder Essentials.....	96
5.14.1	Drag and Drop Folder Management.....	97
5.14.2	Nested Folders.....	98
5.15	Track and Track Parameter Grouping.....	99
5.15.1	Basic Track Grouping.....	99
5.15.2	Track Grouping Matrix Basic Controls.....	101
5.15.3	Track Grouping Indicators.....	101
5.15.4	Master and Slave Group Relationships.....	101
5.15.5	Track Grouping Window.....	102
5.15.6	Track Grouping Window Basic Controls.....	104
5.16	VU Meters on Multichannel Tracks.....	104
5.17	VCA Grouping.....	105
5.18	Audio Jogging and Scrubbing.....	109
5.19	Default Toolbar Summary.....	110
6	Managing Track FX.....	111
6.1	Grouping FX in Folders.....	111
6.2	Backing Up FX Chains and FX Presets.....	112
6.3	Filtering Track FX.....	112
6.4	FX Browser Options.....	112
6.5	Replacing One FX With Another.....	113
6.6	Copying Track FX.....	113
6.7	FX Quick Display.....	114
6.8	Moving Track FX.....	114
6.9	Managing FX Parameters.....	114
6.10	Changing the Default FX Name.....	115
6.11	Renaming Track FX Instances.....	115
6.12	Using Default FX Parameter Settings.....	115
6.13	Hardware Output FX Monitoring.....	115
6.14	Optimizing FX Performance.....	116
6.15	FX Notes and Comments.....	116
6.16	Wet/Dry Mix and Bypass.....	116
6.17	Plug-in Delay Compensation.....	117
6.18	Opening a File in Recovery Mode.....	117

6.19 Stem Rendering.....	117
6.20 Rendering a Group of Tracks to a Single Track.....	118
6.21 Freezing and Unfreezing Tracks.....	118
6.22 Vertical/Horizontal FX Tree Display.....	120
6.23 Adding FX Comments.....	120
6.24 Installing Extra JS Plug-ins.....	120
6.25 Track Templates Revisited.....	120
6.26 ReaEffects User Guide Supplement.....	120
6.27 Drag and Drop from FX Browser.....	121
6.28 Audio Signal Flow Chart: Master Track.....	121
6.29 Audio Signal Flow Chart: Tracks and Folders.....	122
7 Editing Tracks and Items.....	123
7.1 Using an External Editor.....	123
7.2 Editing Items in REAPER.....	123
7.3 REAPER's Smart Editing.....	124
7.4 Standard Windows Editing.....	125
7.5 Editing Behavior Preferences.....	127
7.6 Separating Loop Selection From Time Selection.....	127
7.7 Snapping with Combined Snap/Grid Settings.....	128
7.8 Snapping with Separate Snap and Grid Settings.....	128
7.9 Trim Behind When Editing.....	129
7.10 Item Take FX.....	129
7.11 The Nudge/Set Items Window.....	131
7.12 Media Item Properties.....	132
7.13 Media Item Icons.....	133
7.14 Item Notes.....	133
7.15 Coloring Individual Items.....	134
7.16 Adjusting Item Volume.....	134
7.16.1 The Item Volume Knob/Item Volume Handle.....	134
7.16.2 The Volume and Pan Faders.....	135
7.16.3 Normalizing Items.....	135
7.17 Changing Item Channel Mode.....	135
7.18 Take Source Properties.....	136
7.19 REAPER Editing and Auditioning Example.....	136
7.20 Editing Multiple Media Items.....	138
7.21 Slip Editing.....	139
7.22 Adjusting Fades.....	139
7.23 Crossfades and the Crossfade Editor.....	140
7.24 Crop Project to Selection.....	142
7.25 Grouping Items.....	143
7.26 Storing and Recalling Item Groups.....	144
7.27 Glue Selected Items.....	144
7.28 Creating and Copying Items in Pencil Mode.....	145
7.29 Propagating Items.....	146
7.30 Implode Items To One Track.....	147
7.31 Insert Space in Selection.....	147
7.32 Ripple Editing.....	147
7.33 Trim to Selected Area.....	148
7.34 Free Item Positioning.....	148
7.35 Mouse Modifiers.....	149
7.36 Dynamic Splitting - Remove Silent Passages.....	151
7.37 Auto Trim/Split Items.....	153
7.38 SWS Extensions.....	153
8 Arranging, Comping and Editing Takes.....	155

8.1 Using Item FX with Individual Takes.....	155
8.2 Exploding Takes to Multiple Tracks.....	155
8.3 Crossfades with Takes.....	156
8.4 Exploding Takes in Place.....	156
8.5 Play All Takes.....	156
8.6 Editing and Comping Multiple Takes.....	157
8.7 More Take Commands and Actions.....	160
8.8 Managing Comps with the Project Bay.....	161
8.9 Propagating Takes.....	162
9 Loops, Markers and Regions.....	163
9.1 Creating Loops.....	163
9.2 Creating and Navigating with Markers.....	164
9.3 Time Selection Start/End Markers.....	165
9.4 Snapping to Markers.....	165
9.5 Removing Markers.....	166
9.6 Marker Actions.....	166
9.7 Creating and Using Regions.....	167
9.8 The Region/Marker Manager.....	168
9.9 Project Building with Regions.....	169
9.10 Changing the Project Timebase.....	169
9.11 Markers and Media Cues.....	169
9.12 Tempo Based Music Production.....	170
9.12.1 Time Based Music Basics.....	170
9.13 Project Settings.....	171
9.13.1 Audio Media Item Properties.....	172
9.13.2 Creating a Loop from a Time Selection.....	172
9.13.3 Creating a Loop from Transients.....	172
9.13.4 Transient Detection Settings.....	173
9.13.5 Beat Correction.....	173
9.13.6 Quantizing Items.....	174
9.14 Dynamic Splitting.....	174
9.14.1 Splitting a Media Item into Samples.....	175
9.14.2 Changing the Project Tempo.....	177
9.14.3 Creating a Chromatic MIDI Item.....	177
9.14.4 Saving and Using Samples.....	178
9.15 REX File Support.....	178
10 Pitch and Time Manipulation.....	179
10.1 Changing Pitch for Individual Media Items.....	179
10.2 Using ReaPitch.....	180
10.3 Using ReaPitch with Multiple Tracks.....	181
10.4 Instrument Tuning with ReaTune.....	181
10.5 Pitch Correction with ReaTune.....	182
10.6 Changing the Project Play Rate.....	182
10.7 Time Stretching.....	183
10.8 Stretch Markers.....	184
10.9 Using Time Signature/Tempo Change Markers.....	186
11 The Mixer and Master.....	187
11.1 Introduction.....	187
11.2 Mixer Commands.....	187
11.3 Mixer Layouts and Screensets.....	187
11.4 Mixer Menu Commands and Options.....	188
11.5 Showing and Hiding Types of Mixer Tracks.....	189
11.6 Working with FX in the Mixer.....	189
11.7 Working with Sends in the Mixer.....	192

11.8 Showing Track Icons in the Mixer.....	193
11.9 Managing the Mixer.....	193
11.10 Track Control Menus.....	195
11.11 Introducing Windows Screen Sets.....	196
11.12 Mixer Appearance Preferences.....	197
11.13 Stereo and Dual Panning.....	198
11.14 Master Track Options and Settings.....	200
11.15 Master Hardware Outputs.....	200
11.16 Master Track Channels.....	201
11.17 Avoiding Channel Leakage.....	202
11.18 Reset VU Meter Peaks.....	202
12 Project Management Features.....	203
12.1 Introduction.....	203
12.2 Setting the Project Start Time.....	203
12.3 Locking Media Items.....	204
12.4 Locking Track Controls.....	204
12.5 Project Lock Settings.....	205
12.6 Customizing Colors and Fonts.....	206
12.7 The Project Media/FX Bay.....	207
12.8 The Track Manager.....	211
12.9 Track View Screen Sets.....	213
12.10 Windows Screensets.....	215
12.11 Auto Saving Screen Sets.....	216
12.12 Item Selection Sets.....	216
12.13 Track, Mixer, Transport and Envelope Layouts.....	217
12.14 Further FX Parameter Management.....	218
12.15 Track Control Panel and Menu Bar Help.....	220
12.16 Using Multiple Dockers.....	220
12.17 Saving New Project Versions.....	222
12.18 Multiple Project Backup Versions.....	222
12.19 Associating Rendered WAV Files with Source Project Files.....	222
12.20 Projects and Subprojects.....	222
13 Manipulating and Editing MIDI Items.....	227
13.1 Introduction.....	227
13.2 Monitoring an External Synthesizer.....	227
13.3 Using Track Controls with MIDI.....	227
13.4 Controlling MIDI Data Sends.....	227
13.5 Configuring and Accessing the MIDI Editor.....	228
13.6 The MIDI Editor Window.....	228
13.7 Control Change Messages.....	231
13.8 Control Channel Basics.....	232
13.9 Working with MIDI Editor Lanes.....	233
13.9.1 Sysex Events.....	233
13.9.2 Text Events.....	233
13.9.3 Bank/Program Select.....	233
13.10 MIDI CC Lanes: Tips & Tricks.....	234
13.10.1 General CC Lane Editing Techniques.....	234
13.10.2 Right Click Marquee Selection.....	234
13.10.3 Intelligent CC Lane Dropdown List.....	235
13.10.4 14-bit CC Lanes and Actions.....	235
13.10.5 Resizing CC Lane Height.....	235
13.11 Navigating the MIDI Editor Main Window.....	235
13.12 Basic Note Selection and Manipulation.....	235
13.13 Loop/Time Selections and Smart Editing.....	236

13.14 The MIDI Editor Menus.....	236
13.15 Note Creating and Editing.....	241
13.16 Using the Keyboard.....	242
13.17 Transposing Notes.....	243
13.18 General MIDI Program Patches.....	243
13.19 MIDI Preview Scrub.....	243
13.20 MIDI Editor Modes and Views.....	244
13.20.1 Note Modes.....	244
13.20.2 Note Styles.....	245
13.21 Quantizing MIDI Data.....	246
13.22 Input Quantization.....	247
13.23 Humanize Notes.....	248
13.24 F3 - The Panic Button.....	248
13.25 Using the MIDI Editor: a Basic Exercise.....	248
13.26 Step Recording.....	250
13.27 Working with Multiple MIDI Tracks and/or Items (Overview).....	251
13.28 Managing Multiple MIDI Tracks and Items.....	252
13.29 Editing Multiple MIDI Items.....	253
13.30 MIDI Editor Mouse Modifiers.....	254
13.31 MIDI Editor Actions.....	254
13.32 In-Line MIDI Editing.....	256
13.33 Copying MIDI Items in Arrange View.....	257
13.34 Joining MIDI Items.....	258
13.35 MIDI Preferences Settings.....	258
13.36 MIDI Output Direct to an External Synth.....	259
13.37 Exporting Project MIDI.....	259
13.38 Feedback Routing with MIDI Tracks.....	259
13.39 MIDI Routing, MIDI Buses and ReWire.....	259
13.40 ReaControlMIDI.....	260
13.41 Some MIDI Plug-ins.....	260
13.42 MIDI Controlled Pitch Shift with ReaVoice.....	261
13.43 JS: IX/MIDI_Router.....	262
13.44 Working with Piano Roll Synced to Project Arrange View.....	263
13.45 The Scale Finder.....	263
13.46 Sequencer Megababy.....	263
13.47 Using MIDI CC Messages to Control FX Presets.....	264
14 Music Notation and REAPER's Notation Editor.....	267
14.1 A Brief Introduction to Notation.....	267
14.2 REAPER's Notation Editor: a First Look.....	268
14.3 Opening MIDI Items in the Notation Editor.....	270
14.4 REAPER's Notation Editor: A Closer Look.....	270
14.5 Notation Editor View Options.....	271
14.6 Basic Note Selection and MIDI Editor Tasks.....	272
14.7 Notation Editor Specific Tasks and Functions.....	273
14.8 Working with Notes and Note Selections.....	280
14.9 Exporting and Importing MusicXML Files.....	283
14.10 Making a Notation Editor Toolbar.....	284
15 Customization: Actions, Mouse Modifiers, Menus and Toolbars.....	285
15.1 Introduction.....	285
15.2 REAPER Actions Essentials.....	285
15.3 The Action List Editor Environment.....	286
15.4 Creating a New Keyboard Shortcut.....	289
15.5 Removing an Existing Shortcut.....	290
15.6 Changing an Existing Key Assignment.....	290

15.7	Deprecated Actions.....	290
15.8	Examples of Possible Simple Keystroke Assignments.....	291
15.9	Keyboard Shortcuts for Recording.....	291
15.10	Keyboard Shortcuts for the MIDI Editor.....	292
15.11	Keyboard Shortcuts for the Media Explorer.....	292
15.12	Assigning Actions to the Mousewheel.....	293
15.13	Exporting and Importing Keyboard Shortcuts.....	293
15.14	Creating Custom Action Macros.....	293
15.15	MIDI Editor Custom Macros.....	295
15.16	Importing Scripts.....	295
15.17	Using a Control Device with REAPER.....	296
15.18	Meta Actions.....	298
15.19	Mouse Modifiers.....	299
15.20	Saving and Restoring Mouse Modifier Settings.....	301
15.21	MIDI Editor Mouse Modifiers.....	301
15.22	Customizing the REAPER Menus.....	303
15.23	Customizing the REAPER Toolbars.....	305
15.24	Creating Additional Custom Toolbars.....	308
15.25	Creating Smart Tools.....	309
15.26	The Toolbar Docker.....	310
16	REAPER Plug-ins in Action.....	311
16.1	What Are Plug-ins?.....	311
16.2	The Three Laws of Plug-ins.....	311
16.3	The Five Types of Plug-in.....	311
16.4	Adjusting Plug-in Parameter Controls.....	312
16.5	Sound Shaping Effects: ReaEQ.....	312
16.6	Time Based Effects: Delay.....	313
16.7	Volume Changing Plug-ins: the Limiter.....	314
16.8	Analytical Plug-ins: the Frequency Spectrum Analyzer.....	315
16.9	Using FX Presets.....	315
16.10	Time Based Effects: ReaVerb.....	316
16.11	Volume Control with Compression: ReaComp.....	318
16.12	JS Transients Plug-ins.....	319
16.13	JS De-Esser.....	319
16.14	Volume Control with a Noise Gate.....	319
16.15	Sstillwell Chorus and Delay Effects.....	320
16.16	Noise Reduction with ReaFir.....	321
16.17	Multiband Compression with ReaXComp.....	322
16.18	JS: Time Difference Pan.....	324
16.19	JS: Exciter.....	324
16.20	JS: Huge Booty Bass Enhancer.....	324
16.21	Some Unusual JS Plug-ins.....	324
16.21.1	Utility/bufsave.....	324
16.21.2	JS: Thunderkick.....	325
16.21.3	JS: Tonegate.....	325
16.22	Some Guitar FX Plug-ins.....	326
16.23	Some Other REAPER JS Plug-ins.....	326
16.24	Controlling FX Parameters on the Fly.....	328
16.25	Bridging and VST Plug-in Run Mode.....	329
16.26	Third Party Plug-in Presets.....	329
16.27	Losing the Graphic User Interface (GUI).....	330
17	More REAPER Routing Examples.....	331
17.1	Controlled Bleed.....	331
17.2	Splitting Channels.....	332

17.3 Full and Fat Vocals with ReaDelay.....	334
17.4 REAPER Send Types.....	335
17.5 Channel Splitting and Pitch Shifting.....	336
17.6 Audio Ducking.....	337
17.7 Double Ducking.....	338
17.8 Drag and Drop Routing.....	339
17.9 Using VCA for Track Volume Control.....	340
17.10 Multi Output VSTi Plug-ins.....	341
17.11 Using Parent Channels.....	342
17.12 Parallel FX Processing with the Channel Mixers.....	342
17.13 More Parallel FX Processing.....	344
17.14 Channel Splitting and Parallel Processing with Item Take FX.....	344
17.15 Other Channel Routing Plug-ins (Overview).....	344
17.16 REAPER's Routing Interface.....	345
17.17 ReaSamplomatic and ReaDrums.....	345
17.18 Round-Robin Multisampling.....	347
17.19 Multichannel Track VU Meters.....	349
17.20 Surround Panning with ReaSurround.....	349
17.21 Routing to/from Other Applications with ReWire.....	351
17.22 Introducing ReaRoute.....	352
18 Automation with Envelopes.....	353
18.1 Understanding Automation.....	353
18.2 Automation Envelope Methods.....	353
18.3 The Track Envelopes Window.....	353
18.4 Available Track and Send Envelopes.....	354
18.5 Writing Automation.....	354
18.6 Envelope Points Options.....	356
18.7 Writing Mute Automation.....	357
18.8 Automation Modes.....	357
18.9 Latch Preview Mode.....	358
18.10 Global Automation Override.....	359
18.11 The Envelope Panel Controls.....	359
18.12 Manually Adjusting Envelopes.....	360
18.13 Using the Mouse with Envelopes.....	361
18.14 Envelope Edit Mouse Modifiers.....	361
18.15 Managing Automation Envelope Display.....	362
18.16 The Envelope Panel Controls.....	363
18.17 Managing and Manipulating Envelopes.....	363
18.18 Envelope Shapes.....	365
18.19 Envelopes in Track Templates.....	365
18.20 Envelope Preferences.....	365
18.21 Using an Envelopes Toolbar.....	366
18.22 Moving and Copying Envelopes with Items.....	366
18.23 Automation with Trim Volume Envelopes.....	366
18.24 Locking Envelopes.....	367
18.25 Automation with Grouped Track Parameters.....	367
18.26 Automation with Track Sends.....	368
18.27 Automation with FX Parameters.....	369
18.28 FX Parameter Automation in Learn Mode.....	370
18.29 Automating a VST with MIDI CC Messages.....	370
18.30 Automating FX Parameters on the Fly.....	371
18.31 Automation with Item Take and Take FX Parameters.....	371
18.32 Automation with Hardware Output Sends.....	372
18.33 Automating Automation.....	372

18.34 Actions for Managing Envelopes.....	372
18.35 Automating the Metronome.....	373
18.36 Tempo/Time Signature and Play Speed Envelopes.....	373
19 Automation with Parameter Modulation.....	375
19.1 The Concept.....	375
19.2 The Interface.....	375
19.3 Defining a Parameter for Modulation.....	376
19.4 Defining a Parameter for Modification.....	378
19.5 Parameter Modulation with Audio Control.....	378
19.6 Using an LFO Shape with Parameter Modulation.....	380
19.7 Using Parameter Modulation for Dynamic Compression.....	381
19.8 Bypass Mode.....	382
19.9 Parameter Modulation Under Parameter Control.....	382
19.10 Using Parameter Modulation with an Envelope.....	383
19.11 Parameter Modulation under Sidechain Audio Control.....	384
19.12 Using MIDI Links for Parameter Modulation.....	385
19.13 Further Applications.....	387
19.14 Managing FX Parameters in the Project Bay.....	387
20 Using REAPER with Video.....	389
20.1 Simple Video Editing.....	389
20.2 Video Effects.....	391
20.3 Working with Multiple Video Tracks.....	392
20.4 Video Processor Parameter Controls.....	396
20.5 Video Effects Presets (Examples).....	396
20.6 Understanding Video Formats.....	397
20.7 REAPER Video Processing Tips.....	398
20.8 REAPER Video Settings and Preferences.....	398
20.9 Video Workflow Tips.....	399
20.10 Making a Home Music Video on a Budget.....	400
21 Exporting Files, Mixing Down and Rendering.....	401
21.1 Introduction.....	401
21.2 Batch File Conversion.....	401
21.3 Consolidating and Exporting.....	402
21.4 Rendering A Project.....	403
21.5 Rendering a Finished Song.....	406
21.6 Batch Rendering.....	406
21.7 Rendering Selected Media Items.....	407
21.8 Rendering Regions.....	407
21.9 Burning an Audio CD with REAPER.....	409
21.10 Saving Live Output to Disk.....	411
21.11 Using Presets.....	412
21.12 Rendering in Surround Format.....	412
21.13 Rendering a Video Project.....	413
22 REAPER's Preferences and Other Settings	415
22.1 Introduction.....	415
22.2 General Preferences.....	415
22.2.1 Import and Export Configuration.....	416
22.2.2 Paths and Keyboards.....	417
22.3 Main Project Preferences.....	417
22.3.1 Project Track/Send Defaults	418
22.3.2 Media Item Defaults.....	419
22.4 Audio Configuration and Settings.....	419
22.5 Audio Preferences.....	421

22.5.1 Audio Buffering	422
22.5.2 Audio Playback.....	423
22.5.3 Audio Seeking.....	423
22.5.4 Audio Recording.....	423
22.5.5 Audio Loop Recording.....	423
22.5.6 Audio Rendering	424
22.6 Appearance Preferences.....	424
22.6.1 Appearance Media.....	425
22.6.2 Appearance, Peaks/Waveforms.....	426
22.6.3 Appearance Fades/Crossfades.....	427
22.6.4 Appearance, Track Control Panels.....	427
22.7 Editing Behavior Preferences.....	428
22.7.1 Editing Behavior, Envelope Display.....	429
22.7.2 Editing Behavior, Automation.....	430
22.7.3 Editing Behavior, Mouse Preferences.....	431
22.7.4 Editing Preferences, MIDI Editor.....	432
22.8 Media Preferences.....	433
22.8.1 Media, MIDI Preferences.....	434
22.8.2 Media, Video/REX/Misc Preferences.....	434
22.9 Plug-ins Preferences.....	434
22.9.1 Plug-ins, Compatibility.....	435
22.9.2 Plug-ins, VST	435
22.9.3 Plug-ins, ReWire/DX	435
22.9.4 Plug-ins, ReaScript	436
22.9.5 Plug-ins, ReaMote	436
22.10 Custom UI Tweaks.....	436
22.11 Project and File Management.....	436
22.12 Customizing the Performance Meter.....	437
22.13 Customizing Undo History Behavior.....	437
22.14 Reset REAPER Default Settings.....	437
22.15 Some Other REAPER Options.....	438
23 Main Right-Click Context Menus Summary.....	439
23.1 The Track Control Panel Context Menu.....	439
23.2 The Empty Track List Area Context Menu.....	440
23.3 The Timeline and Ruler Context Menu.....	440
23.4 The Media Items Context Menu.....	441
23.5 The Media Items Context Sub-Menus.....	442
23.6 The Record Arm Context Menu.....	443
23.7 The Envelopes Context Menu.....	444
23.8 The Transport Bar Context Menu.....	445
23.9 The Routing Matrix Context Menu.....	446
23.10 The Grouping Matrix Context Menu.....	446
23.11 The FX Window Context Menu.....	446
23.12 The Media Explorer Context Menu.....	447
23.13 The MIDI In-Line Editor and MIDI Editor Context Menus.....	448
24 Using REAPER with Other Applications and Devices.....	449
24.1 What is ReaRoute?.....	449
24.2 Setting Up Applications for ReaRoute.....	449
24.3 Sending Audio from REAPER to Another Application.....	450
24.4 Sending Audio From Another DAW App to REAPER.....	451
24.5 Using REAPER With a Synth Workstation.....	451
24.6 Syncing to an External Device.....	451
24.7 Generating and Sending Timecode.....	453
24.8 Slaving REAPER to MIDI Sequencer Software.....	453
24.9 ReaMote.....	453

Up and Running: A REAPER User Guide v 5.24

24.10 REAPER and NINJAM.....	454
24.11 ReaScript.....	454
25 Troubleshooting REAPER.....	455
25.1 Input/Output Issues.....	455
25.2 REAPER Interface Issues.....	457
25.3 Troubleshooting Record Modes and Monitoring.....	458
Index.....	461

Summary List of Step by Step Exercises

As well as explanations of REAPER's features and guidance on how you can use them, this User Guide contains a number of step-by-step actual examples which are designed to help you learn. These are summarised below:

Creating a default FX chain.....	43	Customising REAPER's menus.....	305
Layered recording.....	62	Create Custom Toolbar.....	307
Non-destructive punch recording.....	63	Creating a custom toolbar.....	309
Recording multiple takes.....	64	Using sound shaping FX (Intro).....	312
Recording a MIDI track.....	70	Using time based FX (Intro).....	314
Creating and using track folders.....	96	Using a limiter (Intro).....	314
Creating an FX bus.....	97	Using reverb (Intro).....	316
Track and track parameter grouping.....	100	Using a compressor (Intro).....	318
Master/slave grouping.....	102	Using a noise gate (Intro).....	320
The track grouping window.....	102	Using noise reduction plug-ins (Intro).....	321
Copying track FX.....	113	Using a multiband compressor (Intro).....	322
Editing and auditioning media items.....	137	Simple track routing.....	331
Grouping media items.....	143	Parallel FX processing (Intermediate).....	334
Creating and using markers.....	164	Double ducking (Advanced).....	339
Creating and using regions.....	167	Using multi-output virtual instruments.....	341
Using media cues.....	170	Parallel FX processing (Advanced).....	342
Working with FX in the Mixer.....	191	Writing automation envelopes.....	355
Using the width/stereo panner.....	198	Editing automation envelopes (2).....	360
Master track channels (advanced).....	201	Automating track sends.....	368
Track view screen sets.....	213	Automating FX parameters.....	369
MIDI Pitch shift with ReaVoice.....	262	Parameter modulation with audio control.....	378
Creating a custom keyboard shortcut.....	289	Parameter modulation for dynamic compression.....	381
Creating keyboard shortcuts for recording.....	291	Parameter modulation under parameter control.....	382
Creating a custom action macro.....	294	Parameter modulation with sidechain control.....	384
Customising mouse modifiers.....	300		

Summary List of Main Tables

This User Guide includes many instructional and summary tables. In addition to those in Chapter 22 (REAPER's Preferences and Other Settings) and Chapter 23 (Right-click Context Menu Summaries), the most important of these are:

REAPER's Install Options.....	20	Using multiple dockers.....	221
Installed File and Folder Locations.....	28	Commonly used CC messages.....	232
REAPER File Types.....	32	MIDI Editor: Keyboard Shortcuts.....	242
Navigating and Zooming Shortcuts.....	38	Managing Custom Action Macros.....	294
Track FX Management.....	42	Customising the REAPER Menus.....	303
Loop and Time Selection Shortcuts.....	48	Customising the Main Toolbar.....	306
Takes Management.....	66	Guitar FX Plug-ins.....	326
Coloring Tracks.....	90	Sample JS Plug-ins.....	326
Move/Nudge Items.....	126	Channel Routing Plug-ins.....	344
Marquee Modifiers.....	126	Track Parameter and Send Envelopes.....	354
Take Sets and Comp Management (1).....	158	Automation Modes.....	357
Take Sets and Comp Management (2).....	159	Editing Envelopes.....	361
Take Actions.....	160	Managing Automation Display.....	362
Markers.....	164	Manipulating Envelopes.....	363
Regions.....	167	Parameter Modulation.....	376
Managing FX in the Mixer.....	189	Project Rendering Examples.....	405
Managing Sends in the Mixer.....	192	Troubleshooting REAPER.....	455
Windows Screen Sets.....	196	Record Modes and Monitoring.....	459

1 Setting Up and Getting Started

1.1 Downloading REAPER

To download REAPER, visit the download page <http://www.cockos.com/reaper/download.php>. Read the on-screen information carefully (especially about 32 bit and 64-bit) and be sure to select the correct version for your computer. If you keep the program for more than 60 days then you must purchase a license. To purchase your REAPER license, go to <http://www.cockos.com/reaper/purchase.php>

After downloading you will need to install the program. There are differences in the installation process for OS X (Mac) and for Windows (PC).

1.2 Installing REAPER on an OS X Mac

To install REAPER on a Mac (OS X) follow this procedure.

1. Double-click on the REAPER disk image (.dmg) file to open it.
2. If you agree to accept the licence conditions, click on **Agree** to open this file.
3. Drag and drop the REAPER icon (shown right) into your **Applications** folder.
4. If you also want to install **ReaMote**, drag this icon too into your Applications folder. If you choose not to do this, you can do so later.



To pin REAPER to the dock, simply drag and drop the REAPER icon from the Applications folder on to the Dock. We strongly recommend that you should also, under **System Preferences**, ensure that for your **Mouse** right click is enabled as a secondary button.

1.3 Installing REAPER on a Windows PC

To install REAPER on a PC with Windows you should follow this sequence:

1. In Windows Explorer, find the install file. The file name includes the current version number, e.g. **reaper50-install.exe**.
2. Double click on this file to start the install program.
3. Click the **I Agree** button to accept the conditions and continue.
4. For a normal install, accept the default folder offered to you (but see note below) - for example, **C:\Program Files\REAPER**.
5. If you need to, enable the **Portable install** option (see note below), then click **Next**.
6. Select which elements you wish to install (if in doubt accept the default settings - see also section 1.4 below) and click on **Install**.
7. Wait while the program installs. When prompted, click on **Close** to close the Install program. You will be asked if you wish to run the program now: in this case, choose **No**.

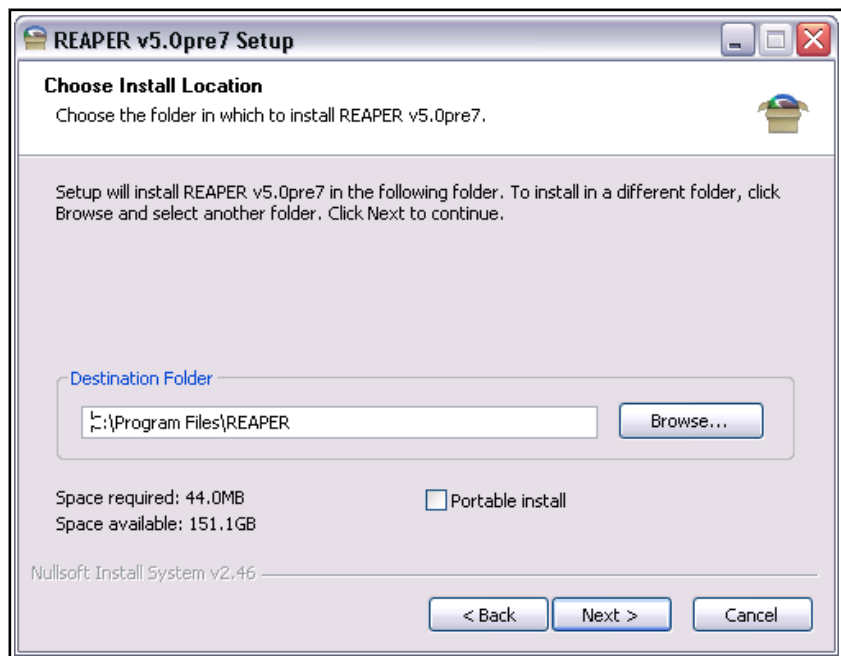

Up and Running: A REAPER User Guide v 5.24

Note: If you are installing REAPER for the first time, or if you wish to replace an earlier version of REAPER with this one, you should accept the default destination folder and not enable portable install. If you wish to install this alongside an existing earlier 5.xx version, change the default directory (e.g. to \REAPER5) and enable portable install. This will ensure that your earlier 5.xx settings and preferences will be preserved separately.

Tip: If you choose not to install any REAPER program elements or options, you can later change your mind by simply running the install program again.

1.4 The Install Options (Windows only)

The Install screen lets you decide which REAPER elements you choose to install and which ones you prefer not to install. Listed below is a summary of your main options. By default, most of them are enabled.

Item	Explanation
Required files	These are the files that REAPER needs to perform effectively. You have no choice but to install these.
Optional Functionality	JSFX library. This is an extensive collection of audio (choruses, filters, limiters, etc.) and MIDI (sequencers, arpeggiator, chorderizer, etc.) effects that can be used with your tracks and media items. It is recommended that you install these. VST/x64 VST bridging/firewalling. These options allow for greater flexibility in the use of VST plug-ins. For example, they allow 32 bit plug-ins to be used on a 64-bit version of REAPER. If in doubt, you should install these. ReaMote, ReWire, ReaRoute. These enable REAPER's various advanced routing capabilities, such as controlling the passing of audio/MIDI material between REAPER and other programs. If you choose not to install these, you can reinstall REAPER to add them at any time in the future.
Desktop Icon	Leaving this option selected ensures that a REAPER shortcut icon will be placed on your Windows desktop.
Start Menu Shortcuts	Leave this option ticked to ensure that REAPER is added to your Windows Start Menu.
Associate with RPP Files	Ticking this option will enable you to open REAPER with any of your REAPER Project files direct from Windows Explorer or any desktop shortcut that you might create for your projects.

1.5 Enabling MP3 Recording

If you are intending to record and/or mix down your recordings in, or convert other recorded material to, MP3 format, you will need to install an MP3 encoder. A suitable encoder is LAME, which is available free of charge. This can be obtained from any of many web sites, including <http://aegiscorp.free.fr/lame/>. Once there, make sure that you select the right download for your system and your version of REAPER:

Windows 64-bit systems	lame_enc64.dll
Windows 32 bit systems	libmp3lame.dll
OSX 64-bit systems	libmp3lame_osx64.zip
OSX 32 bit systems	libmp3lame_osx32.zip

Note that if you are using a 32 bit version of REAPER even on a 64-bit computer, you should download the 32 bit encoder, not the 64-bit one.

After downloading, Mac users should unzip the file and then drag the dynamic library file (named something like **libmp3lame.dylib**) into their REAPER application launch folder.

Windows users should copy the file into their REAPER Program directory, which by default will be **C:\Program Files\REAPER**. It can also be copied to other applications that may need it (e.g. Audacity).

1.6 REAPER Software Updates

REAPER is updated frequently and regularly, with bug fixes, new features and other enhancements. You can check for updates at any time by visiting <http://www.reaper.fm/> Simply download and install. There is no need to first uninstall any previous version. Existing preferences and settings will automatically be carried over.

Tip: REAPER is frequently updated. An option is available under **Options, Preferences, General** (Startup Settings) to have REAPER automatically check for updates each time the program is started (provided of course that you are on-line at the time). By default, this option is enabled. If you do not wish to be notified whenever a new version is available, you can disable it.

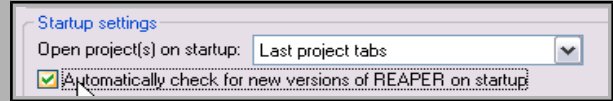

1.7 Starting REAPER

To start REAPER, just double click on the REAPER desktop icon. You might also wish to consider creating a keyboard shortcut for this. For Windows users, this is done using the **Shortcut** tab of the icon's **Properties** dialog box. Right-click over the icon to display this.



1.8 REAPER Startup Tips

By default, REAPER opens with the last used project. As you will see in Chapter 22 (under Preferences, General), you can change this behavior if you wish. In addition, you can use hot keys when starting REAPER to override the default settings.

Action	Booster Key(s)
Open REAPER without loading last project.	Shift (while starting REAPER)
Open REAPER without loading any default project template.	Ctrl Shift (while starting REAPER)

1.9 REAPER Selections, Controls and Commands

Working in REAPER involves making selections and giving commands. For example, to copy a single item you would select the item (usually using your mouse) and then give the command for REAPER to copy it. Other times, you will use commands that affect the whole project file without any selection. For example, you might wish to save all your work. In that case, there would be no need to select anything – you would only need to give the necessary command. There are four main methods commonly used to give commands in REAPER:

Method	Comment									
The Main Menu	As with other applications, this is accessed by the mouse or keyboard.									
Context Menus	Click your right mouse button over an item or area of the screen to display a context menu relevant to where you have clicked.									
Toolbars	Click your mouse on any toolbar button for its command to be executed.									
Keyboard Shortcuts	Many commands and actions can be accessed by keyboard shortcuts. You can also assign own shortcuts to other commands and actions. Chapter 15 will show you how. In some cases, different modifier keys are used for the PC and for the Mac. The examples used throughout this guide are PC (Windows) shortcuts. Mac users should refer to this summary table of similarities and differences:									
	<table border="1"> <thead> <tr> <th>PC (Windows) Key</th> <th>Mac (OS X) Key Equivalent</th> </tr> </thead> <tbody> <tr> <td>Shift</td> <td>Shift</td> </tr> <tr> <td>Control</td> <td>Command</td> </tr> <tr> <td>Alt</td> <td>Option</td> </tr> <tr> <td>Windows</td> <td>Control</td> </tr> </tbody> </table>	PC (Windows) Key	Mac (OS X) Key Equivalent	Shift	Shift	Control	Command	Alt	Option	Windows
PC (Windows) Key	Mac (OS X) Key Equivalent									
Shift	Shift									
Control	Command									
Alt	Option									
Windows	Control									

Up and Running: A REAPER User Guide v 5.24

1.10 The REAPER Screen

REAPER allows you to select from a number of different color themes. The screen shots used in this book mostly use the REAPER 4 default theme. If you are using any other theme, you might therefore notice some visual differences. If this causes you any difficulties, consider switching to the default theme. In some cases modifications have been made to enhance clarity when greyscale printing.

When you start REAPER, it displays a screen similar (but not necessarily identical) to that shown below. The example shows a very simple project file that has been opened. The table below the illustration introduces briefly each of the main screen elements.

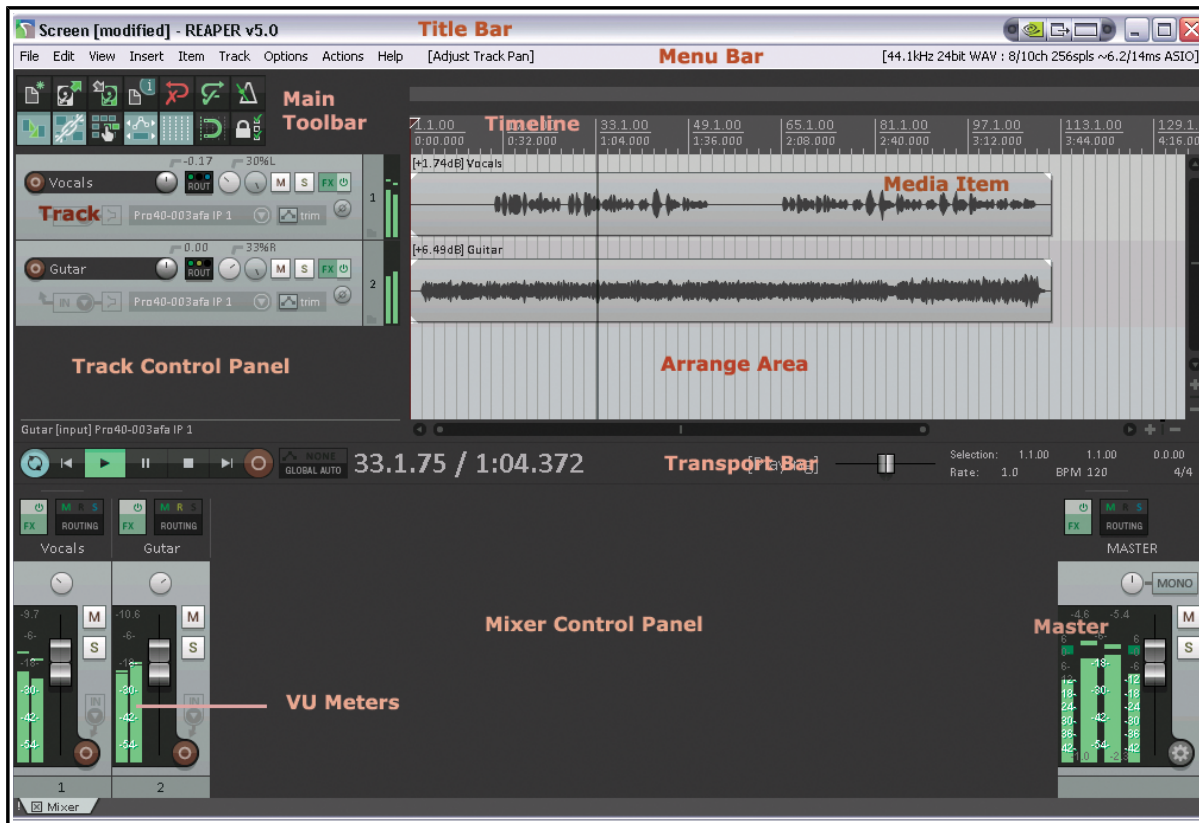

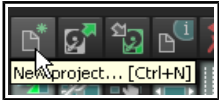
Element	Explanation
The Menu Bar	This displays the Main Menu near the top as a row of commands – File, Edit, View, Insert, Item, Track and so on. As in other Mac and Windows applications, the menu is used to give commands.
The Main Toolbar	Just below the menu are two rows of seven buttons each. This is the REAPER Main Toolbar. Depending on the color theme in use, your buttons might not look the same as those shown. However, as with other programs, you can hover your mouse over any button to obtain a tooltip (see example, left).  The various icons are introduced and explained throughout this guide as they are needed, and summarized at the end of Chapter 5. In Chapter 15 you will be shown how you can customize this toolbar.
The Timeline	The timeline runs across the top of the REAPER window, just to the right of the main toolbar. It measures the length of your project and helps you identify the position of the various media items. In the example shown, the timeline is measured and displayed in both measures/beats and minutes/seconds.

1 - Setting Up and Getting Started

Element	Explanation
The Arrange Area: Main Window and Workplace!	This is to the right of the Track Control Panel. It displays the actual media items (audio and/or MIDI) that make up your tracks. In this example, there are two tracks each containing one media item . As you will see in Chapter 20, video items can also be included.
The Track Control Panel (TCP)	This area is controls the behavior of your audio and MIDI tracks – in this example there are two tracks, labelled Vocals and Guitar. You can have as many tracks as you need, subject only to any limitations imposed by your hardware. Each track has its own set of controls (faders, rotaries and buttons). We'll get to what these controls do and how they are used in Chapters 2 and 4.
The VU Meters	Each track (and the Master) uses Volume Unit Meters – VU Meters – as a visual indicator of the level of the track's audio signal strength (volume). These are visible in both the Track Control Panel and the Mixer.
The Transport Bar	This is used to control recording and playback – for example, to start and stop recording. We'll look at this in Chapter 2.
The Mixer and Mixer Control Panel (MCP)	This is displayed (in this example) across the bottom of the screen. It shows your tracks in a different way. In this example two tracks are shown: these are the same tracks as is shown in the TCP. Notice that this also includes a Master output track. The output of the Master is what you actually hear when you play your tracks and media items. The Mixer and Master will be explored in detail in Chapter 11.

Don't be surprised if your screen doesn't look quite the same as this, or even if it looks a lot different. The REAPER screen can be customized to suit your individual needs. We'll be covering this in Chapter 2.

1.11 The Track and Track Controls

If you've used other DAW software before you'll probably want to get to grips with REAPER's track controls as soon as possible.

This illustration shows the most commonly used of these. The exact position of some of them will vary with track control panel width. You can hover your mouse over any control for a tooltip. In most cases you click on a control to use it (for example, click on Mute button to toggle mute status of any track, click and drag on Volume control to adjust the volume level), and right click on a control for a menu of commands, options and/or settings.

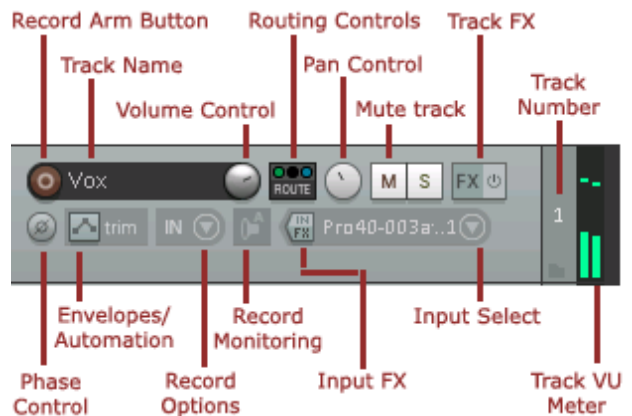

If some of these controls are not visible, you may need to increase the track panel width or height. Hover your mouse over the right or lower panel boundary so that your mouse cursor becomes a double headed arrow, then click-drag to the right or downwards.

Depending on your track layout, the volume control may be a rotary control (as shown above) or a horizontal fader. Also, you might see a rotary width control next to the pan control (as shown, right): if so, ignore it for now. We'll get to it in later chapters. In fact, all of these controls will be explained further as you work thru this guide.



1.12 Setting Up For Audio

Before you can record or play anything, there are a few setup options that have to be specified. This section covers setting up audio. This is where you tell REAPER which audio device(s) you have, and how you wish to use them. There are differences in how you should do this for a Mac under OS X and a PC under Windows

In addition, it is also advisable to disable **System Sounds**. For OS X users, this is done in System Preferences. Windows users should use the Control Panel.

1.12.1 Setting Up For Audio (PC Windows)

To set up your Audio Device, first choose the **Options, Preferences** command from REAPER's Main Menu, then under **Audio** select **Device** from the list on the left.

If on the other hand you plan to use the PC's internal sound card, you should familiarize yourself with its control software (usually opened from the Windows Control Panel). This is especially important to prevent previously recorded material from being mixed back in, and re-recorded with, new material when more tracks are later overlaid. You should also consider using ASIO4ALL drivers, which are available free of charge. For more information, see en.wikipedia.org/wiki/Audio_Stream_Input/Output

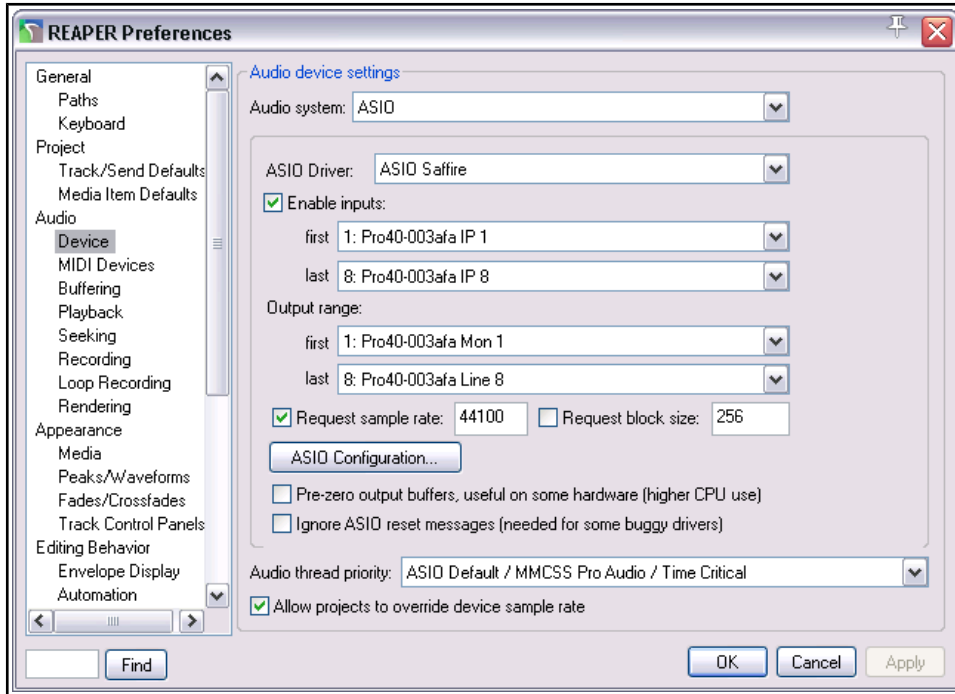

On the Audio Device Preferences screen, you should set the following options:

Item	Comment
Audio System	The other items on this screen will vary with the audio system selected . Choose ASIO and ASIO drivers if they are available for your sound card or Firewire or USB device.
Enable Inputs	This option needs to be turned on (ticked) if you wish to use REAPER for recording.
Input Range	If your device has multiple inputs (up to 512), specify the first and last that you want to be available. In this example, eight inputs are available, allowing up to eight microphones or lines (in any combination) to be used simultaneously for recording.
Output Range	If your device has multiple outputs (up to 512), specify the first and last that you wish to be available. Usually, your MASTER bus will direct output to a single pair of outputs, but you can use the others also if you wish.
Request sample rate/block size	You can set sample rate and block size either here or using your sound card's own control software. If unsure, start with 44100 and 512.
ASIO Configuration	Clicking this button gives you direct access to the Control Software for your sound card or other audio device.
Audio Thread Priority	Assigning a higher priority will ensure that audio threads will be processed ahead of other threads (e.g. graphics).

1.12.2 Setting Up For Audio (Mac OS X)

Audio devices on the OS X are set up and selected in the OS X **Audio MIDI Setup**. Make sure you have first downloaded and installed the latest Mac updates You should also check your Audio Device in REAPER. To do this, start REAPER and choose the **Options, Preferences** command from REAPER's Main Menu, then under **Audio** select **Device** from the list of headers in the column on the left.

In the first example shown below, a USB Saffire device (a Focusrite Saffire Pro 40) has been installed. Saffire has therefore been selected so as to ensure that this device is used for both input and output. You can (as

1 - Setting Up and Getting Started

shown here) set the sample rate and block size (which helps determine latency) here, or you can independently open the device's own control panel and set them there. If unsure, set these at 44100 and 512 to begin with.

If you wish to use the Mac's internal sound card, you may need to take steps to prevent existing material being mixed back into, and re-recorded with, additional tracks when they are added later.

To do this, you will need an aggregate device. Open the OS X **Audio MIDI Setup** then click on the **+** in the bottom left corner of the window to create such a device. Add to this aggregate device the built in input and built in output as shown here. If you wish to rename it, double click on the text **Aggregate Device**.

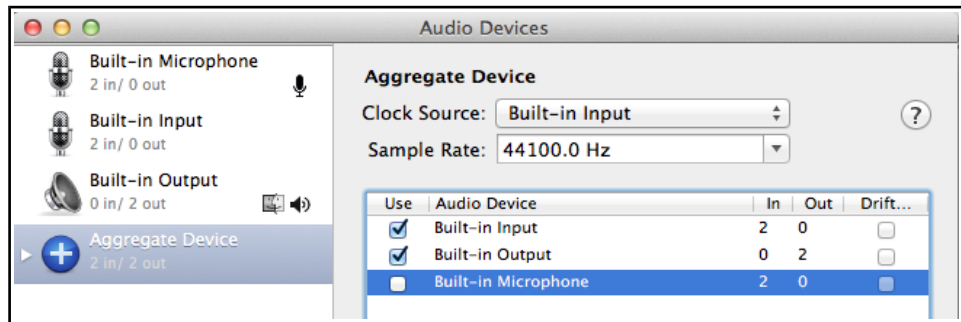
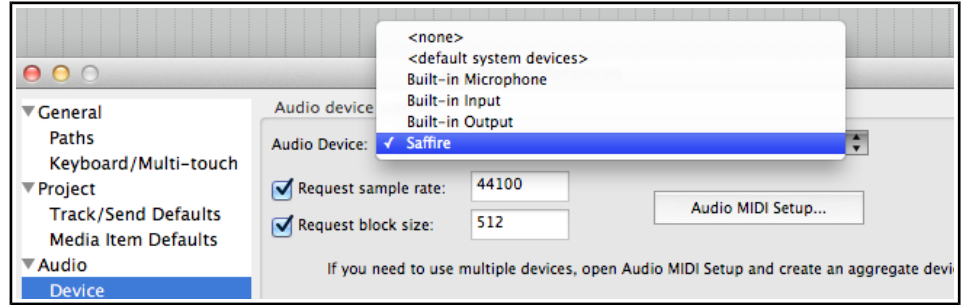

Next, in REAPER's **Audio, Device** preferences screen, select your aggregate device and **Apply** your changes. You will now be able to use your headphones with the computer's audio out socket and your microphone with its audio in socket.

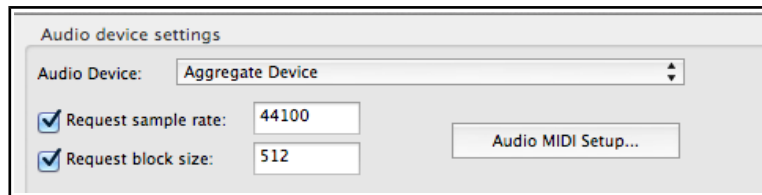

Using an aggregate device can also resolve other routing issues which can arise when using built-in inputs and outputs.

1.13 Input Aliasing

REAPER supports **Input Aliasing**. This is the ability to give your own names to your audio inputs. It can be used to shorten the long names that the system will often give to these inputs, especially when your device supports multiple inputs. An example of the use of this feature might be to change names like **Analog In 1 Delta 1010 (1)**, **Analog In 2 Delta 1010 (1)** and so on to just **Mic/Line 1**, **Mic/Line 2**, etc.

Input Aliasing is accessed from the **Audio Preferences** screen. Select **Input Channel Name Aliasing/Remapping**. The method is similar to that used for output aliasing – see section below.

1.14 Output Aliasing

REAPER also supports **Output Aliasing**. This enables you to give names to your audio outputs, names that make sense to you. This is especially useful if your sound card or other audio device provides multiple outputs. For example, one pair of outputs might be connected to your control room monitors, another to studio monitors, and a third pair to a multi-output headphone monitor. By default, your outputs will have names something like those shown here (above right). Clearly, these names are not very useful to you.

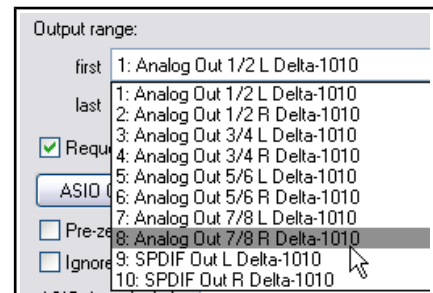

By assigning aliases to these outputs, you can ensure that whenever you need to list them (for example, when determining the destination of the output from your Master) your own names will be displayed, instead of the hardware device names.

Example

To create output aliases:

1. Choose the **Options, Preferences** command.
2. Display the **Audio** page and in the section labelled **Channel Naming/Mapping** make sure you have ticked the option **Output Channel Name Aliasing** (this is almost the last item on this screen).
3. Click on the **Edit Names/Map** button for this item.
4. Double-click in the Aliased Names column on each item in turn to edit them. In each case, after typing your preferred alias, click on **OK** to return to the **Output Channel Alias/Mapping** window.
5. Click on **OK** to close this window and return to the **Preferences** dialog box.
6. Click on **OK** to close the Preferences dialog box.

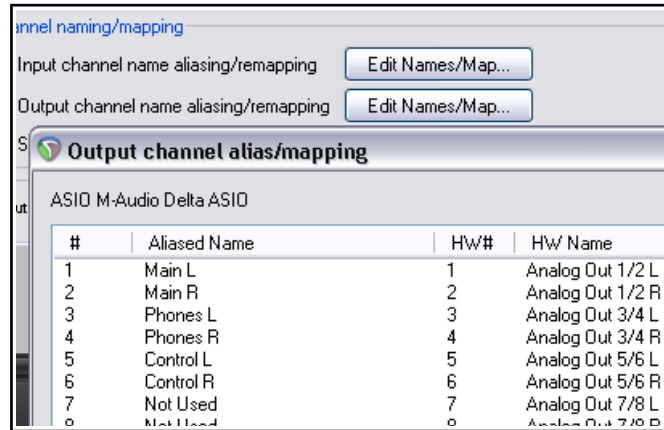

Your specified names should now automatically be used throughout REAPER. The topic of actually assigning outputs to tracks will be covered later, beginning with Chapter 2.

1.15 Setting Up For MIDI

If you intend to use MIDI at all, you should enable your MIDI devices. Many PCI sound cards, Firewire and USB audio devices include a MIDI input and output port (for use, for example, with a MIDI Keyboard). Choose **Options, Preferences** from the Main Menu, then display the **MIDI Devices** screen under **Audio**. You can select in turn each of the listed MIDI Input and Output devices, right-click over its name, then

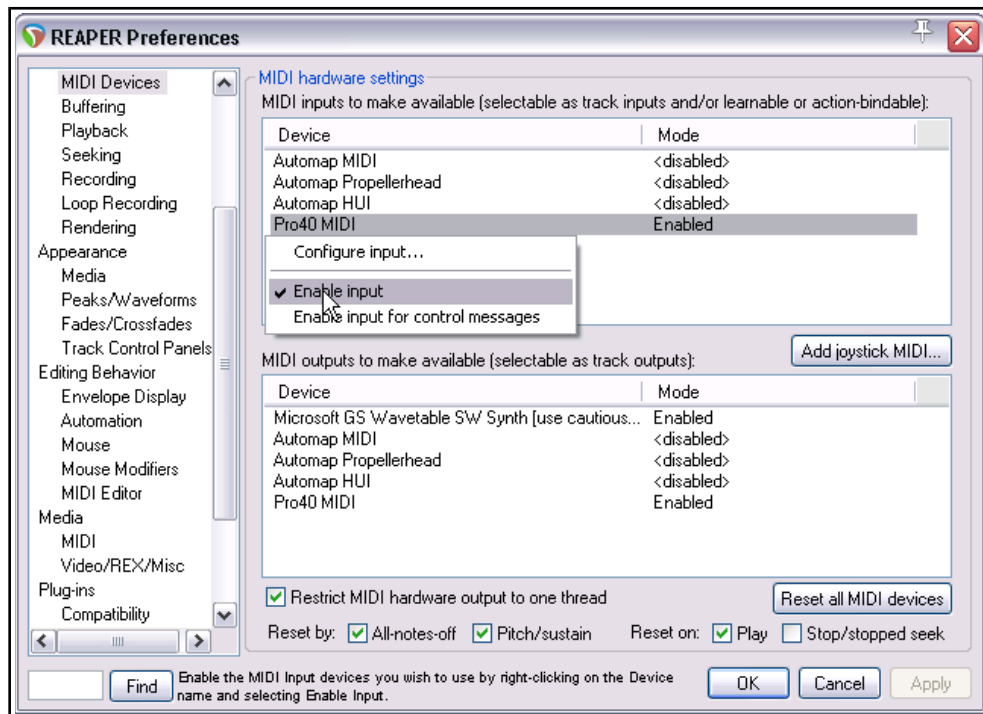

choose **Enable Input**. You can double-click on any input device name to display its **Configure MIDI Input** settings (see below right). This enables you to assign your own name (or alias) for the device, or to specify your advanced timestamp options (if required). You can also **Enable input for control messages** if you wish to use the device as a MIDI controller – see also Chapter 15.

To assign your own name or to specify a time offset for any MIDI Input or Output device, right click over the device name and choose **Configure Output** from the context menu.

If you have a joystick that you wish to use with REAPER you should click on the **Add joystick MIDI** button then select the device name and processing mode. You can also specify whether you wish to use it for Virtual MIDI Keyboard input and/or as a MIDI control/learn device.

If you wish to use a Control Surface, such as a Behringer BCF2000 or BCR2000, with REAPER, then you should set its input mode to **Control Only**. The use of Control Devices will be explained later in this guide, notably in Chapters 11 and 13.

Reset Options

Towards the bottom of the MIDI Devices preferences window there are options for **Reset by** (all-notes-off and/or pitch/sustain, and **Reset on** (play and/or stop/stopped seek). These affect only hardware devices.

Other Audio Preferences

You can see that there are other Audio Preference screens that we have not yet examined, including **Buffering, Playback** and **Recording**. These will be dealt with later in this User Guide, particularly in Chapter 22. When getting started, you should be able to just leave these settings at their defaults, only returning to change them later if you find that you wish or you need to do so. When finished, clicking on **OK** will, of course, close the **Preferences** box and cause your settings to be remembered.

This section has covered the general issues involved in setting up your system for working with MIDI. For project specific settings and options, see Chapter 2. In particular, if you are working primarily with MIDI material you may wish to change the default project timebase setting. This too is explained in Chapter 2.

1.16 Enabling VST Plug-ins

There's one further Preferences screen you will probably want to visit before you get started – **VST Plug-ins**. As with Audio Preferences, REAPER has several pages of Plug-in Preference screens, but these can (at first at least) be left to their default settings.

However, if you already have a collection of VST and/or VSTi Plug-ins on your computer (including VST3), REAPER needs to be told where to find them. Note that VST3 plug-ins should be kept in a directory or directories separate from other plug-ins.

Choose the **Options, Preferences**

command, then select **VST** under the **Plug-ins** section. You can use the **Auto-detect** button to locate your plug-ins, but if they are spread across several directories REAPER

might not find them all. In this case, you can click on the **Add** button to specify the location(s) of the folder(s) where your other VST plug-ins are stored. You can leave most other settings as they are (at least for now).

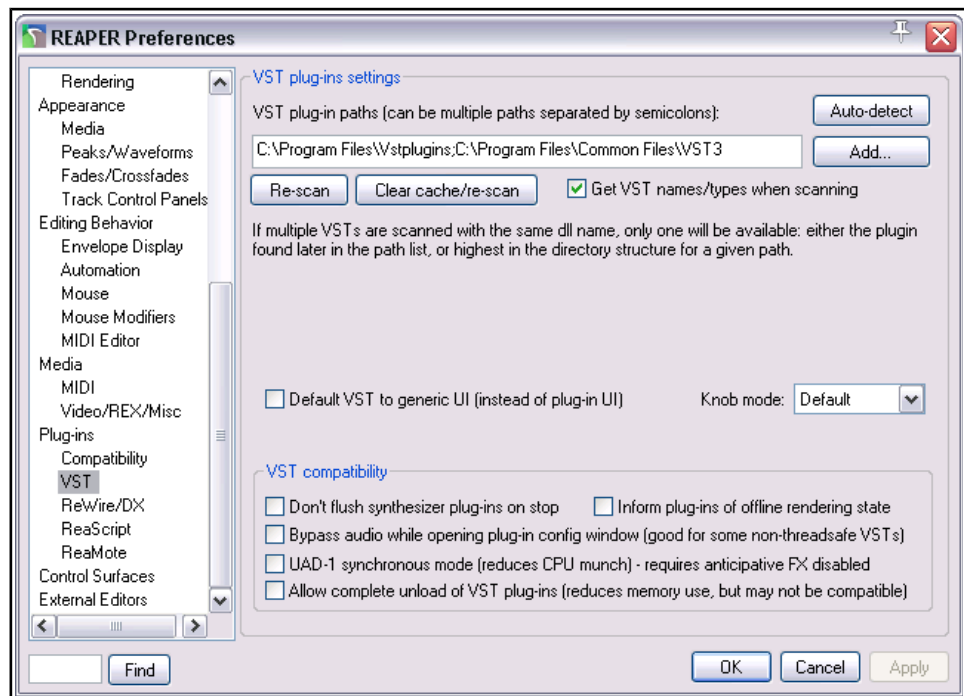
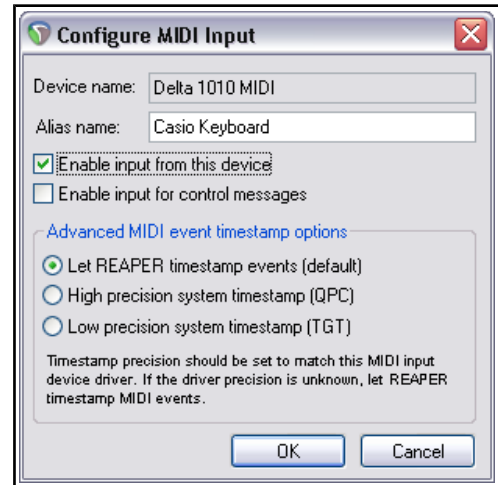

Up and Running: A REAPER User Guide v 5.24

OS X uses two “built in” folders for installing shared plug-ins. These are **~/Library/Audio/Plug-Ins** and **~/Users/<your account>/Library/Audio/Plug-Ins**. REAPER will scan these by default: you should, however, check that they are automatically listed as your VST plug-in paths. If not, you should add them.

Windows does not locate any such folders for you. You will need to identify and specify where your VST plug-ins have been installed. If your VST plug-ins are spread across more than one folder (this is not unusual), you will need to use the **Add** button several times, each time selecting one of your folders. Use the **OK** button in the **Browse for folder** window each time after selecting the folder name. Clicking the **Re-scan** button in the above window will then make the contents of your VST and VSTi folder(s) available immediately. REAPER will also scan any subfolders.

REAPER will automatically scan your VST folders each time the program is launched. You can also return to this screen at any time and add more VST folders later. Specify the extra location(s) of your VST plug-ins, then **Re-scan** then **Apply** then **OK** to close this screen and cause your new settings to be remembered. You can find more information about the various VST Preferences settings and options in Chapter 22.

1.17 REAPER’s Installed Folders and File Location

The locations to which REAPER's various resources are installed will depend on whether you are using OS X or Windows, and even then which version. For example,

Windows 7 behaves differently from XP. To identify where the various files are located, choose **Show REAPER resource path in explorer/ finder** from the **Options** menu.

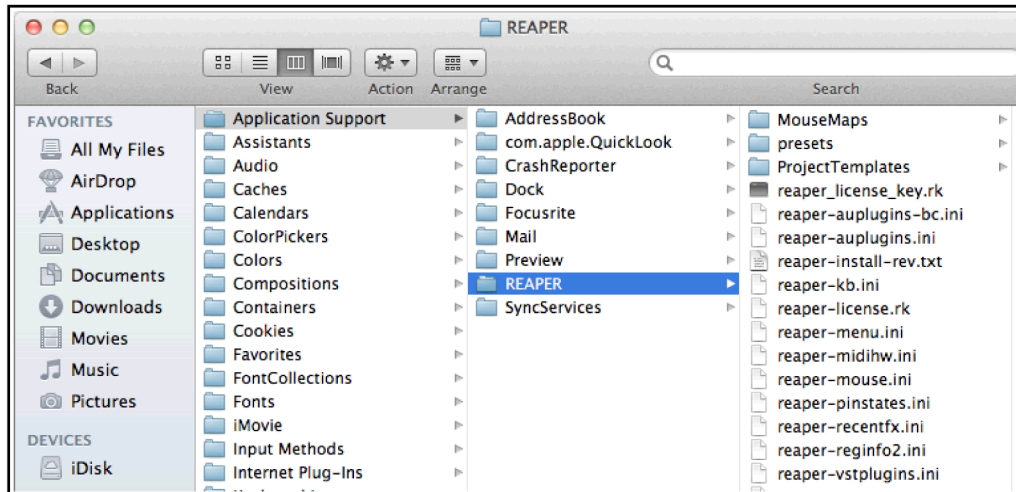

Shown here is an example of the OS X Finder path. The Windows Explorer display is similar.

Several of these files will be referenced elsewhere in this User Guide. Meanwhile, you might find the information in the following table helpful:

REAPER’s Installed Folders and File Locations	
The Registry (Windows only)	Windows users note: REAPER does <i>not</i> store any install data, settings or preferences in your Windows Registry. Windows will set up an item for REAPER under HKEY_LOCAL_MACHINE, Software but it contains no data other than keeping a record of your file movements in Registry areas such as its MUICache and creating file associations, so that you can open .RPP files (for example, in Windows Explorer) by double-clicking on them.
The REAPER Install Directory – OS X	OS X installs REAPER to its Applications folder. Copy any PDF files (such as this User Guide) that you want to be able to access from REAPER's Help Menu to: <username>/Library/Application Support/REAPER With some versions (e.g. Lion) you may need to hold down the Options key while displaying the Go menu to make this path accessible.

REAPER's Installed Folders and File Locations			
The REAPER Install Directory - Windows	<p>By default, REAPER on Windows installs to C:\Program Files\REAPER. Copy into this directory any PDF files (such as this User Guide) that you want to be able to access from REAPER's Help Menu.</p> <p>Some of the optional install items are held in sub-folders of C:\Program Files\REAPER. These include the COCKOS ReaPlug VST plug-ins and (if installed) the SWS Extensions. Anything stored in this directory is accessible to all users of REAPER on this computer.</p> <p>Most REAPER features (such as configuration files and custom settings) are placed into an Applications Data or AppData folder. The location of this will depend upon which version of Windows you are using.</p>		
The Application Data/Support Directory	<p>To access the REAPER AppData or Application Support folder, choose Options, Show REAPER resource path... from REAPER's main menu. Some of the main items you can expect to find there are listed below.</p>		
Sub Directories	<p>You should find that you have a number of sub-directories here, such as:</p> <table style="width: 100%; border: none;"> <tr> <td style="width: 50%; vertical-align: top;"> <p>Color Themes</p> <p>Configurations</p> <p>Cursors</p> <p>Data</p> <p>Effects</p> <p>FXChains</p> <p>KeyMaps</p> </td> <td style="width: 50%; vertical-align: top;"> <p>MenuSets</p> <p>Presets</p> <p>Project Bays</p> <p>ProjectTemplates</p> <p>QueuedRenders</p> <p>Scripts</p> <p>TrackTemplates</p> </td> </tr> </table> <p>Many of these are self-explanatory, especially those which contain the various files and items that you can create yourself as an aid to managing your REAPER projects. For example, any FX Chains that you create will be stored on the FXChains sub-directory. Custom menu and toolbar data is stored in the MenuSets sub-directory, and so on.</p> <p>Topics such as creating FX Chains and Custom Menus are covered elsewhere in this user guide.</p> <p>Information held in the Data directory includes track icons and toolbar icons. The Effects folder is where your JS effects are stored.</p>	<p>Color Themes</p> <p>Configurations</p> <p>Cursors</p> <p>Data</p> <p>Effects</p> <p>FXChains</p> <p>KeyMaps</p>	<p>MenuSets</p> <p>Presets</p> <p>Project Bays</p> <p>ProjectTemplates</p> <p>QueuedRenders</p> <p>Scripts</p> <p>TrackTemplates</p>
<p>Color Themes</p> <p>Configurations</p> <p>Cursors</p> <p>Data</p> <p>Effects</p> <p>FXChains</p> <p>KeyMaps</p>	<p>MenuSets</p> <p>Presets</p> <p>Project Bays</p> <p>ProjectTemplates</p> <p>QueuedRenders</p> <p>Scripts</p> <p>TrackTemplates</p>		
preset-vst-plugname.ini	<p>For each VST plug-in, a separate file is used to store any presets that you have created or imported.</p>		
REAPER.ini	<p>This includes all of your Options, Preferences settings, information about your last screen layout, and your recently used projects history.</p>		
reaper-dxplug-ins.ini reaper-vstplug-ins.ini	<p>These files store information about your installed plug-ins.</p>		
reaper-reginfo.dat reaper-reginfo.ini	<p>Store your product registration data</p>		
reaper-recentfx.ini	<p>This file stores a list of your recently used FX: this list is used to produce the Recently Used FX submenu that is available in the Mixer.</p>		
screensets.ini	<p>This file stores details of your windows screen sets. Note that track screen sets are stored with the relevant .RPP file.</p>		
Specify Default Paths for Saving new projects, Recording and Rendering (see also Chapter 22).	<p>You can use the General, Paths page of your Options, Preferences to specify default paths saving new projects and for your recorded media items. For recorded media, however, any path specified in your Project Settings will take precedence over this.</p> <p>You can also specify default paths for your waveform peak files and for project rendering.</p>		

Up and Running: A REAPER User Guide v 5.24

There's one more thing that might interest you here. All of the settings, preferences and custom files are text files. Any of them can be opened and modified using a text editor such as Notepad. This even applies to REAPER's project files, with .RPP extension. Of course, most probably you will never need to do this, and if you do, you should always take a copy first, just in case of any errors or accidents. However, you should **never** try to use a text editing program to open, view or edit any file ending in **.app, .dmg, .exe** or **.dll**

1.18 Localization and Language Packs

Selecting a language pack causes REAPER to use that language for its menus, dialog boxes, tool tips, and so on. The default language is U.S. English. Language packs are managed from the **General** page of REAPER's **Preferences**.

To see what language packs are available, and to download any, click on the link **Download language packs** (see below). This will take you to a URL where you can follow the links (including to REAPER Stash) to find your language. After downloading, close the Preferences window and use the command **Options, Show REAPER resource path in Explorer/Finder** to display REAPER's resource folders. Next, drag and drop the downloaded file(s) into the LangPack folder.

To select a language pack other than U.S. English, select from the drop down list (right) and click on **OK**. You will need to restart REAPER for the language to take effect.



1.19 Backing Up Settings

In this chapter you have been introduced to some of REAPER's settings and preferences. As you progress, you will find many more. You can back up these settings and preferences at any time. This can be a good precaution to take against system failure, and can also be used to ensure identical REAPER installations on two or more machines. The procedure for doing this is explained in Chapter 22 under the heading "Import and Export Configuration." Don't be concerned if you do not yet understand the meaning of many of the options. Just keep it in mind that this facility is always available.

If uncertain about what to back up, it can be a sensible precaution to backup all your configuration settings from time to time, each time to a new ReaperConfig.zip file. How often you should do this really depends on how often you make changes to any of your settings, and how important those changes are to you. Remember to keep a copy of your ReaperConfig.zip files off line, for example on an external drive or a USB flash drive.

1.20 Running REAPER on a Flash Drive

You can install REAPER on a USB flash device, or other external drive. This ensures, for example, that if you are going to be away from home or your normal workplace, you can take your USB Stick (or external drive) with you, plug it in to a computer, and away you go. Before you can install REAPER on a flash drive, it makes sense to first install it on your hard drive. When you then install REAPER to an external device in this way, all your settings, preferences etc. are also migrated.

The install method is different for OS X and Windows users.

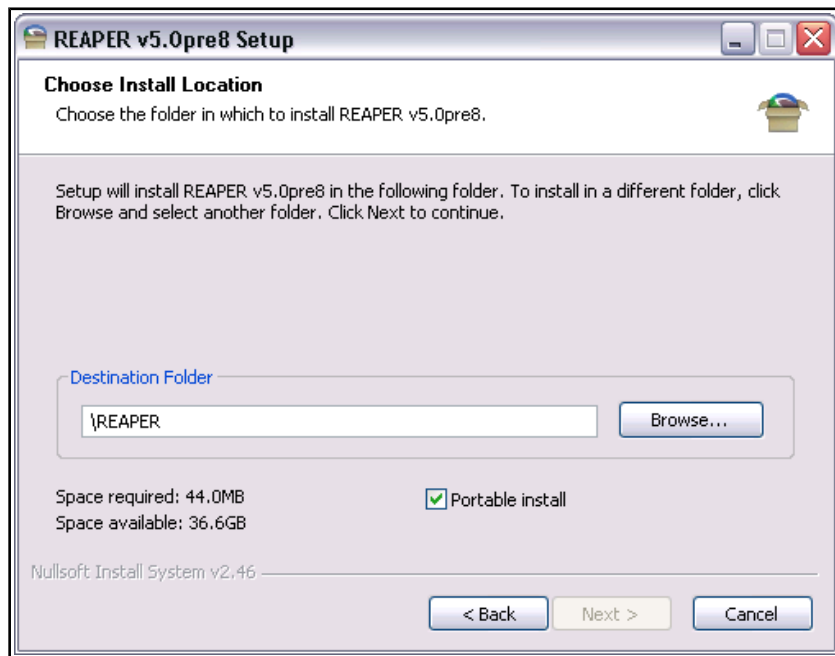

OS X

1. Insert the flash drive into a USB port. Create a new folder on this flash drive, e.g. REAPER4. In this folder create an empty text file called reaper.ini
2. Open the Mac folder containing the REAPER disk image (.dmg) file: this will most likely be Downloads.
3. Double click on the .dmg file to open it. Drag and drop the REAPER icon to the new folder on the flash drive.
4. Be patient. There is a large number of files to be transferred. This can take 10 minutes or more.

Windows

1. Insert your external device into an available USB port on your PC. Note its drive letter (e.g. E:, F:, G:, H:, I:, etc.). This will depend how many internal hard drives, disk partitions, external hard drives, DVD burners, etc. you have already installed.
2. Double click on the REAPER install file to start the install process.
3. Click on **I Agree** to accept the license agreement. The Choose Install Location window will be displayed.
4. Enable the option for **Portable install**.
5. Click on **Browse**. Select your flash drive and click on **Make New Folder**. Name the folder (e.g. REAPER) and press **Enter**.
6. On returning to the screen shown here, work your way thru the installation process in the normal way.
7. Wait while the various files are installed. There are a lot of files and this might take quite a few minutes.

1.21 REAPER Start Menu Options (Windows only)

Normally to start REAPER you can simply double-click on your Windows desktop shortcut. This will cause REAPER to be started in accordance with your existing preferences and settings. However, for times when you do not wish to do this, you should also be aware of other options available from the Windows **Start** menu.

Click on the **Start** button, then **All Programs** then **REAPER** to be presented with a flyout menu of choices:

Menu Command	Explanation
Install REAPER to USB key	This can be used to install REAPER to a Flash drive or similar device. However, the method described earlier in this Chapter is simpler!
ReaMote Slave	The use of ReaMote is beyond the scope of this User Guide. However, you can read an overview in Section 22.
REAPER	Starts REAPER normally, with last project.
REAPER (create new project)	Starts REAPER with a new project file.
REAPER (reset configuration to factory defaults)	Starts REAPER and resets all settings, options and preferences to factory defaults. Use this with caution!
REAPER (ReWire slave mode)	Opens REAPER as a ReWire slave. This is beyond the scope of this User Guide, but is discussed in overview towards the end of Chapter 17.
REAPER (show audio configuration on startup)	Starts REAPER with the Audio settings Preferences page.
REAPER License	Displays License information.
Uninstall REAPER	Uninstalls REAPER. If you need to uninstall REAPER for any reason, you should always use this method.
Whatsnew.txt	Opens the text file displaying a history of new features and changes introduced in each version of REAPER.

Up and Running: A REAPER User Guide v 5.24

1.22 REAPER File Types

Like any other program, REAPER creates a series of files that it uses to store your work. Some of the main file types and their purposes are described in the table below, along with other useful information.

File Type	Example	Explanation
.RPP REAPER Project File	Alone.RPP	This file is the core of your project. It holds all the information about your tracks, your media and their settings. .RPP files are stored in text format.
.RPP-bak Project Backup File	Alone.RPP-bak	When you save an existing project file, the previous version is saved with the .RPP-bak extension. You can recover a project from its previous state by opening the backup file.
.RPP-UNDO Undo History File	Alone.RPP-UNDO	This file type will be created if you select the option to save your undo history with your project files. This option is included in the Undo Settings section of the General settings in your Options, Preferences window. This topic is explained more fully in Chapter 2.
.reapeaks REAPER Peaks File	Vox.wav.reapeaks	These files contain the information necessary to enable REAPER to draw the waveforms etc. on your media items.
.reapindex REAPER Peaks File	Vox.wav.reapindex	These files contain index information about your individual media items.

1.23 Pops and Clicks

You're nearly ready to start making music with REAPER! Before you do, though, you should take a few moments to read this section, which deals with the not uncommon problem of unwanted pops and clicks being heard when you play back your music. This is a computer issue rather than a REAPER specific issue, and is generally less likely to occur with a Mac than with a PC.

If you encounter the sound of unwanted pops and clicks when you play back a song in REAPER, then most probably all it means is that your audio device settings are not right for your computer. As a quick fix, try adjusting the block size (Preferences, Audio, Device), starting at 128 and working up thru, 256, 512, 768 or 1024 to find the lowest setting for your system at which you can play back your music without any pops or clicks getting in the way

If you do encounter this problem, you should also read Chapter 22 to learn more about this topic.

1.24 Uninstalling REAPER

There is no need to uninstall your current version of REAPER before installing a new one. Your existing installation will automatically be upgraded from the new installation. However, should you wish to uninstall REAPER for any reason, OS X users should simply drag the REAPER icon into Trash and then remove the folder **~/Library/Application Support/REAPER**.

Windows users should follow this procedure:

1. Click on the Windows **Start** button, then **All Programs**, then **REAPER** then **Uninstall REAPER**.
2. When the REAPER Uninstall Wizard is displayed, click on **Uninstall**.
3. When the uninstall process is finished, click on **Close**.
4. When prompted, choose **Yes** if you wish to see which files have been left on your Hard Drive, otherwise choose **No**.

Tip: If you are likely to be reinstalling REAPER at some later date, do not remove these files. This will ensure that your previous settings and preferences will be recalled when it is reinstalled.

2 REAPER Project Basics

2.1 Section Overview

In this chapter you will be taught the essential basics about working with a project file in REAPER. Topics include opening and closing files, navigating the REAPER environment, working with tracks and audio effects, and more. Most of the topics introduced here will be covered in greater depth and detail later in this guide.

2.2 Opening an Existing Project

To open an existing REAPER Project File, use the **File, Open Project** command, or the keyboard shortcut **Ctrl O**. As with other Windows Apps, you will need to navigate to the appropriate folder to find your project. Recently used projects can more easily be opened using the **File, Recent Projects** command. This causes a list of up to the last 100 recently used project files to be displayed. You can then select any file from that list.

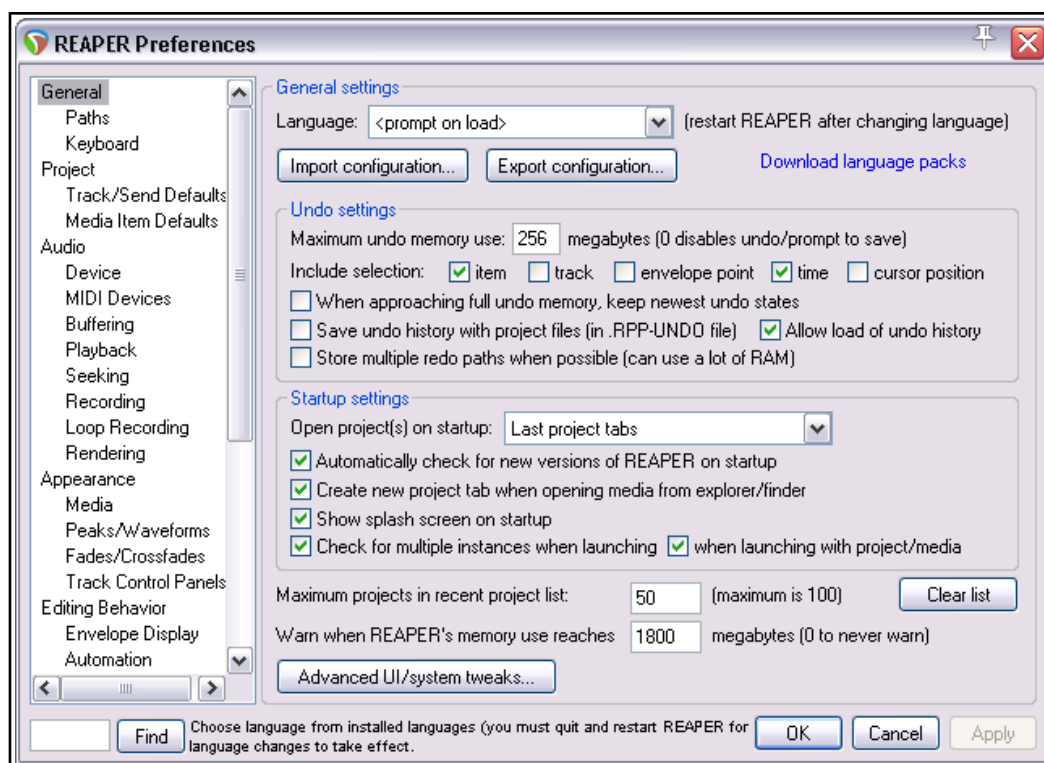

The **General** page of your **Options, Preferences** window offers a number of options. In particular, you can:

- ◆ Manage your **Undo** preferences (see Chapter 2).
- ◆ Specify whether or not you want the most recently used file automatically loaded when REAPER is started. Choose the **Last active project** option for this. Other startup options are explained in Chapter 22.
- ◆ Specify whether you want to **Automatically Check for New Versions of REAPER on Startup**.
- ◆ Determine the number of files displayed on the **Recent project list**.

Other General Preferences settings are discussed and explained in Chapter 22.

Notice too the toggle command **Continuous scrolling** on the **Options** menu. If disabled (the default), the play cursor will scroll from left to right during playback. If enabled, this cursor will find and then remain stationary in the center of the arrange window during playback, while the media items scroll across the screen.

The examples used throughout this guide use the project file **All Through The Night.RPP**. This can be downloaded from www.cockos.com/wiki/index.php/REAPER_User_Guide. It might help you to keep that project open while using this documentation. Take a copy of this file and work with that. You will then be able to experiment freely without fear of damaging any of your own important projects.

2.3 Project Settings

REAPER project settings can be defined to meet the requirements of individual projects. The **Project Settings** dialog box is accessed by choosing the **File, Project Settings** command, or by using the keyboard shortcut **Alt Enter**. The dialog box has five pages of settings - **Project Settings, Media, Video, Advanced** and **Notes**. If in doubt, leave most settings at their default values, at least until you understand better what they are and how they work.

Project Settings: Project Settings

These include:

- **Project Sample Rate:** for example, 44100 Hz (CD standard) or 48000 Hz (DVD standard).
- Option to force the time signature to beats or whole samples.
- Project **beats per minute** and **time signature**.
- Method for setting the **timebase** for items/envelopes markers and for tempo/time sig - essentially you have a choice of Time, Beats (position, length rate) or Beats (position only). See notes below.
- **Project start** time and measure. Leave these at their defaults for now. In Chapter 12 you'll see when, why and how to change them.
- Playback and render **resample mode** – from Lowest (point sampling) thru Medium (64 Sinc) to Extreme HQ (768 HQ Sinc).
- **Default mode** and **parameter to be used for pitch shifting**. See Chapter 10.

Project Settings: Media

These include:

- **Paths** (primary and secondary) to store media files. For example, if you specify "Audio" then your media will be stored in a folder called Audio, as a sub-folder of the project folder. If left blank, REAPER will use the same folder as the project file.
- **Recording format** - typically WAV or MP3, but there are others, e.g. AIFF, DDP, FLAC, OGG Vorbis Video (GIF) and WavPack. Each of these comes with its own set of options and settings.
- **Settings** and specifications for chosen recording format – e.g. for WAV files this includes Bit Depth.
- Preferred **media formats** when FX are applied, or items are glued or frozen, and when media items are **rendered**. Also, default media format for **project** and **regions**. You have the same range of formats, options and settings as you have for recording format.

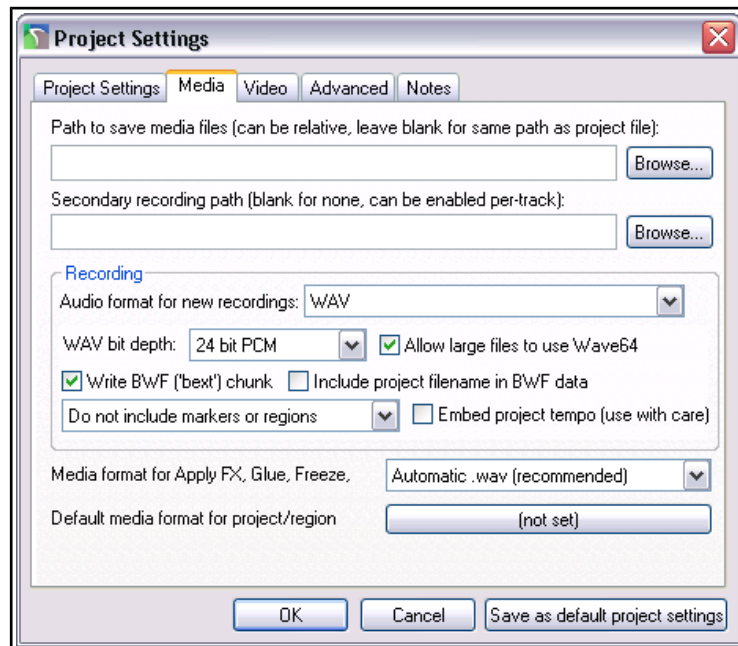
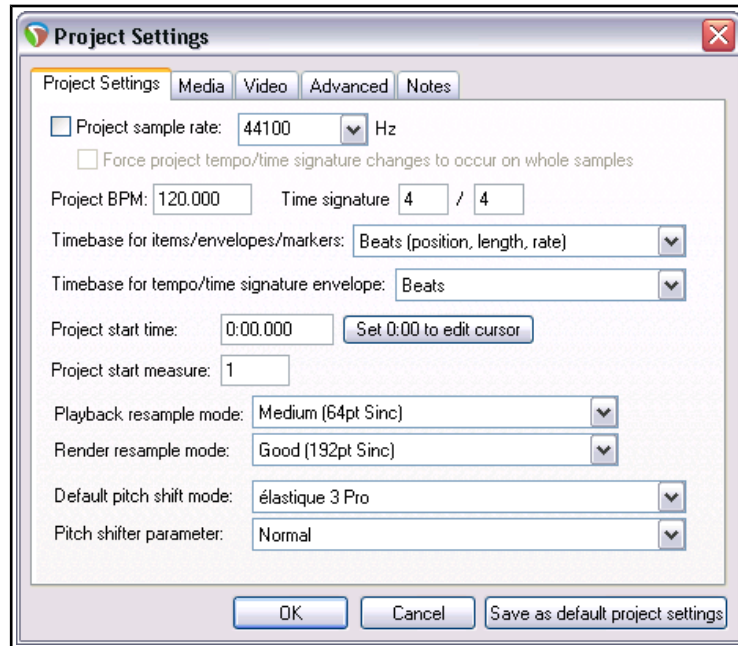

Project Settings: Advanced

- **Item Mix Behavior.** Determines how REAPER should behave when one media item is placed directly on top of another. The options are for Enclosed Items to Replace enclosing items, Items always to be mixed, or for the newer item to always replace the older item.
- **Track mixing depth.** If unsure, leave at the default setting.
- The option to allow **feedback in routing.** Feedback routing can be useful for some advanced mixing activities, but can be dangerous for audio equipment. *If you are in any doubt, do not select this option.*
- The option to **synchronize** the project with the timecode of an external device.
- The option to limit **project length** and recording time.
- Specifying a **default pan law** for your tracks. The pan law determines how the relative volume of a track behaves when that track is panned more or less to one side or the other. **Gain compensation boost** can be enabled or disabled. Pan laws are discussed in more depth in Chapter 2. Meanwhile, if you are unfamiliar with how pan laws work, leave these at their default settings.
- **Default track pan mode.** You have choice of pan modes, some mono, some stereo. See Chapter 11.

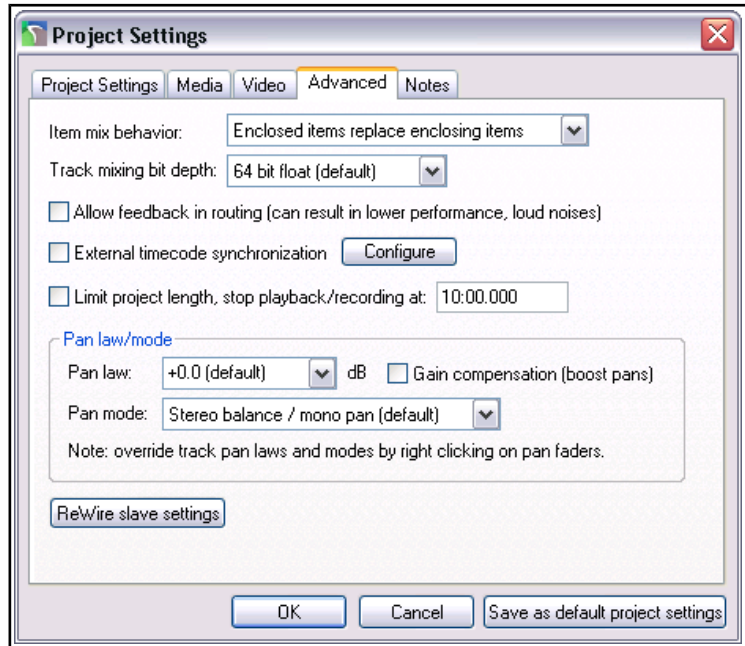

Project Settings: Video: These are explained in Chapter 20.

The Project Timebase Settings

The project timebase controls how media items, envelopes and project markers behave when the project tempo changes. When possible, get your project timebase settings right *before* you record or import any items. The default settings are **Beats (position, length, rate)** for items/envelopes/markers and **Beats** for tempo/time sig envelopes. For more information about the timebase, open the **Actions list** (from REAPER's main menu) and run the action **Project settings: timebase help**. For more about the Actions List, see Chapter 15.

It's worth also noting that you can still over-ride the project timebase setting for individual tracks within your project. To do this, select the track(s) and choose **Set track timebase** from the track control panel context menu. To do this for an individual item, select the item then press **F2** to display the Item Properties dialog box.

Project Settings: Notes

This very handy section lets you enter any notes and comments that you would like to be included with your project file. You can specify that the notes should automatically be displayed each time the project is opened.

Tip: You can save all these settings as the defaults to be used for future new projects. Of course, for any individual projects you can over-write your defaults.

2.4 Directing Audio Output

Audio output will by default go from your master to the first available pair of outputs on your soundcard (usually outputs 1 and 2), and only to this pair. If your sound card has multiple pairs of outputs and you wish to change this, you can do so via the **Routing Matrix (View, Routing Matrix or Alt R).**

Your available hardware outputs are displayed along the top of the grid. Here you can select and/or deselect any of the available outputs.

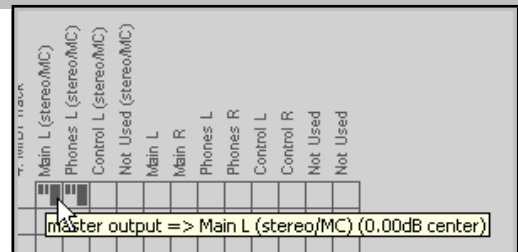

2.5 The Transport Bar

If the Transport Bar is not visible in your REAPER window, use the **View, Transport** command to display it, or use the keyboard shortcut **Ctrl Alt T** to do this. The Transport Bar might appear as shown here, as a floating window (undocked) inside REAPER, or it might be docked just below arrange view. At this stage, the exact position of the Transport Bar is not important. The main Transport Controls are shown below, though your exact layout might not be identical: **whether docked or not, the controls will appear in a single row if the window is wide enough.**

The first five transport buttons are fairly standard – **Go to Start, Go to End, Stop, Play, and Pause.**

The **Stop** button stops playback and returns the play cursor to the position it

was in when playback started. The **Pause** button pauses playback without moving the play cursor.

The **Record** button starts and stops recording, without stopping playback. Clicking on the **Stop** button when recording is taking place will both stop playback and recording. The **Toggle Repeat** button turns on and off the option for any looped time selection to be played over and over again during playback.

The **Global Automation Override** feature will be explained in Chapter 18. To the right of this the current **time selection** is shown (start position, end position and length). This topic will be covered later in this chapter and in Chapters 6 and 8.

The current **play cursor position** is also shown: in the above example this is 29.2.54/0:56.722. Next to this is the **playback status** (Playing, Paused or Stopped). Next are edit boxes that show the project **Tempo (BPM)** and **Time Signature** values. To change the value of either box click in the box and type the new value. Depending on your mouse preferences (Chapter 22), you can also use your mousewheel to adjust this. Finally (in the above layout) is the **playback rate**. This can be made faster or slower by adjusting the horizontal fader. If adjusted, the fader background is colored green. Double-clicking resets the rate to 1.0. You can also hover your mouse over the box and use your mousewheel to increase (up) or decrease (down) the value.

Three other useful transport control keys are **Ctrl Left** (go back a little), **Ctrl Right** (go forward a little) and **Alt Space** (play, skipping loop selection).

Right clicking over the Transport Bar displays a context menu. This may seem slightly intimidating at first. We'll get to the more advanced stuff in Chapter 9, but for now just notice that there are menu options available to:

- Select your preferred time display format.
- Dock or Undock the transport in the Main Window. You can choose the main dock or any of four other positions – **Below arrange view, Above ruler, Bottom of main window or Top of main window.**

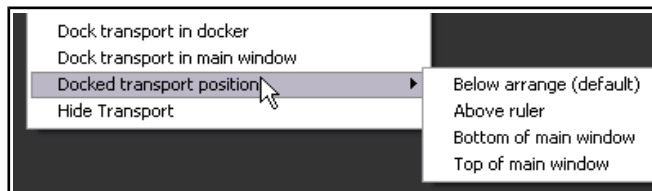

Scrubbing

The top of the edit cursor is marked by an upside down triangle. You can grab this with your mouse and drag to move the edit cursor without affecting playback. Depending on your preferences settings, you may need to hold down the **Shift** key while you do this. If you do this when the project is not playing, it will have the effect of "scrubbing" your audio.

This topic is covered in more detail in Chapter 5 of this User Guide.



2.6 The Big Clock

Use the **View, Big Clock** command (or press **Alt C**) to toggle on and off the display of the Big Clock, which clearly displays the current position of the Edit Cursor. This window can be sized and moved at will, or docked in the docker. Right clicking over the Big Clock gives you a context menu of options, including changing the display format.

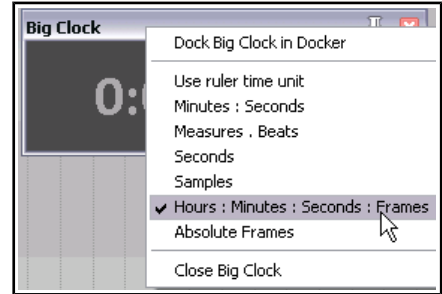

2.7 Track Controls

If you play **All Through The Night.RPP** you will notice that the same sound is coming out of both speakers and that the different instruments and vocals are all competing with each other for the same acoustic space. That's because no adjustments have been made to the Volume or Pan controls for these tracks. The exact position of these faders varies with factors like width and height of the your control panel and which of the available track layouts is in use.



The rotary fader shown here is used to adjust a track's **volume**. With some layouts, this will be shown as a horizontal fader. The rotary not far to its right adjusts the **panning**, sending the signal more to the left or the right as preferred. If you see a second pan control, ignore it for now. This is used with some pan modes to control stereo width: this is a more advanced concept, primarily used for folders and tracks with stereo media files. This will be covered in Chapters 10 and 11. For now, we will be working with just the one pan control. In any event, to adjust any horizontal, vertical or rotary faders in REAPER, you can:

- Click and hold down the left mouse button over the fader, then drag in the direction required, releasing the mouse when finished. For rotary faders, drag up to rotate clockwise, down for anti-clockwise. Hold **Ctrl** while doing this for more subtle adjustments.
- Hover your mouse over the fader, use the Scroll Wheel to adjust the level down/up. To enable this feature, go to **Options, Preferences, Editing Behavior, Mouse** and deselect **Ignore mousewheel on track panel faders** and **on all faders**. See mouse behavior preferences in Chapter 22.

Right-clicking on the volume control opens the routing dialog box (shown right). You can enter values as dB for volume (e.g. -6) and as percentages for pan (e.g., 25R for 25% right) and width directly into this box.

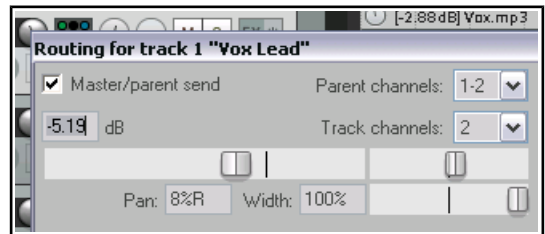

By default, the volume and pan controls apply to a track's **audio** output. If you want to use these to control its **MIDI** signal, right-click on the track number in the TCP, then choose **MIDI track controls**, then **Link track volume pan to all MIDI channels** from the context menu (see Chapter 13).

Tip: To audition possible changes, hold down the **Alt** key while dragging the fader with the mouse. When you release the mouse, it will then return to its original position.

Tip: To work with more than one track, hold down **Ctrl** while clicking in the Track control panel on each track number required. Then release **Ctrl**. Any fader or other movement will be applied to all selected tracks.

The two buttons to the right of the width control fader on each track's control panel have these functions:

Mute	Toggles Mute on/off for selected track(s)	Note: Both the Mute and Solo controls can also be used with modifier keys such as Alt and Ctrl for various functions. See Chapter 5 for details.
Solo	Toggles Solo on/off selected track(s)	

By default, track **Solo** causes the track itself and the output of any sends originating from that track to be played. If you wish to hear only the track without these sends, hold the **Alt** key while soloing the track. Notice that your track controls also include a **phase control** button. This can be used to reverse track polarity.

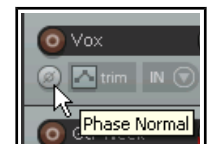

2.8 Pan Law and Pan Mode

You can also change the **pan law** for individual tracks. Right-clicking over a track's pan fader opens a window where you can select from the list (in a range 0.0 dB to -6.0 db) or type in your own value. A negative setting causes the signal at the center to be attenuated as panning increases. The **Gain compensation (boost pans)** option can be enabled to cause the signal's audio strength to instead be boosted as it is panned.

Another option is to select your preferred **pan mode** (see right). This is quite a complex topic and will be explained and dealt with more fully in Chapter 11 when we look at stereo panning. In brief, however, you have a number of options – **Stereo balance/mono pan** is the default (see Project Settings). This is equivalent to the panning mode used in versions of REAPER before REAPER 4. If you select REAPER 3.x balance, stereo pan or dual pan, the width panner will also automatically be displayed. Several of the screen shots used in this guide illustrate dual pan controls. The various pan modes are explained, along with stereo and dual panning, in Chapter 11.

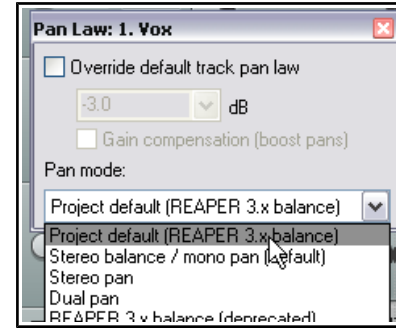
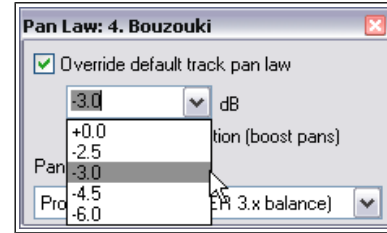

2.9 Navigation and Zooming

Navigating within the Track Control Panel

The following keyboard shortcuts can be used to navigate within the Track Control Panel:

Function	Keystroke
Go to next track.	Ctrl Alt Down
Go to previous track.	Ctrl Alt Up

Adjusting Panel Width with Mouse

To adjust the width of the track panel area, place your mouse over the vertical border that separates the track control panel area from the main workspace area, until the mouse indicator changes to a horizontal black double headed arrow. Click and hold down the left mouse button while dragging the mouse left or right. Release the mouse button when the desired track control panel width is reached. Note that double-clicking on this vertical border will toggle track panel visibility on and off.

Adjusting Track Height with Mouse

Function	Action
Adjust height of single track	Click/drag up/down on lower track boundary
Adjust height of selected tracks	Alt + click/drag up/down on lower track boundary
Adjust height of all tracks.	Ctrl + click/drag up/down on any lower track boundary
Adjust height of all tracks.	Click/drag up/down between + and – on vertical scrollbar

Toggling Track Height with Keyboard or Mouse

Function	Keystroke
Toggle between normal track height and minimised track height, all tracks	` (this is the key immediately to the left of 1 , usually directly above the Tab key).
Toggle between normal height and maximising currently selected track.	~ (on most keyboards, this is the Shift key in combination with the ` key).
Expand height of selected tracks, minimise all others. Press again to restore all tracks to same height.	! (on most keyboards, this is the Shift key in combination with the 1 key).
Minimise all tracks.	@ (on most keyboards, Shift with the 2 key).

Function	Keystroke
Toggles height of all tracks between minimised, normal and maximised.	Double click mouse on vertical scroll bar

Zooming In and Out with the Keyboard

The following keyboard shortcuts can be used for zooming within a project:

Function	Keystroke
Zoom Out vertically, decreasing track height	Page Down
Zoom In vertically, increasing track height	Page Up
Zoom to current time selection	Ctrl Num Pad +
Zoom Out to entire project length	Ctrl Page Down
Zoom Out horizontal	- (the minus sign)
Zoom In horizontal	+ (the plus sign)
Zoom Out media peaks	Shift Down
Zoom In media peaks	Shift Up

Scrolling with the Keyboard

The following keyboard shortcuts can be used for scrolling within a project:

Function	Keystrokes
Scroll View down	Alt Down
Scroll View up	Alt Up
Scroll View left	Alt Left
Scroll View right	Alt Right

Zooming and Scrolling with the Mousewheel

The mousewheel can also be used for zooming in and out when you are navigating a project file. The table below summarises how the mouse wheel behaves.

Behavior	Modifier Key for Mousewheel	
Horizontal Zoom	(no modifier)	Note: REAPER's zoom center settings will determine exact zoom behavior. These can be found in the Editing Behavior section of your Preferences . See Chapter 22 for more information.
Vertical Zoom	Ctrl	
Horizontal Scroll	Alt	
Vertical Scroll	Ctrl Alt	

You can change any default keyboard and mousewheel assignments. For example, you could use just the Down and Up arrows (without Ctrl Alt) to go to the next or previous track, or the mousewheel without a modifier to scroll rather than zoom. You can also use other customized mouse modifiers for zooming, especially within the Arrange view and Ruler contexts. **Mouse modifiers** are covered in Chapter 15.

Tip: Making and using a zoom/navigate toolbar. Zooming and navigating are activities that are performed a lot. You might wish to consider making your own Zoom/Navigate custom toolbar. It isn't as complicated as it might sound. How to create your own custom toolbars is explained in Chapter 15.

2.10 Keyboard Shortcut and Mouse Defaults

You can use the command **Help, Keybindings and Mouse Modifiers** (or just press **Shift+F1**) to open your web browser with a list of REAPER's mouse modifiers and keyboard shortcuts. As you will see in Chapter 15, you can also define your own mouse modifiers, keyboard shortcuts and action keys, so that your mouse and keyboard behavior is determined by the context in which you are using it.

2.11 Using the Navigator

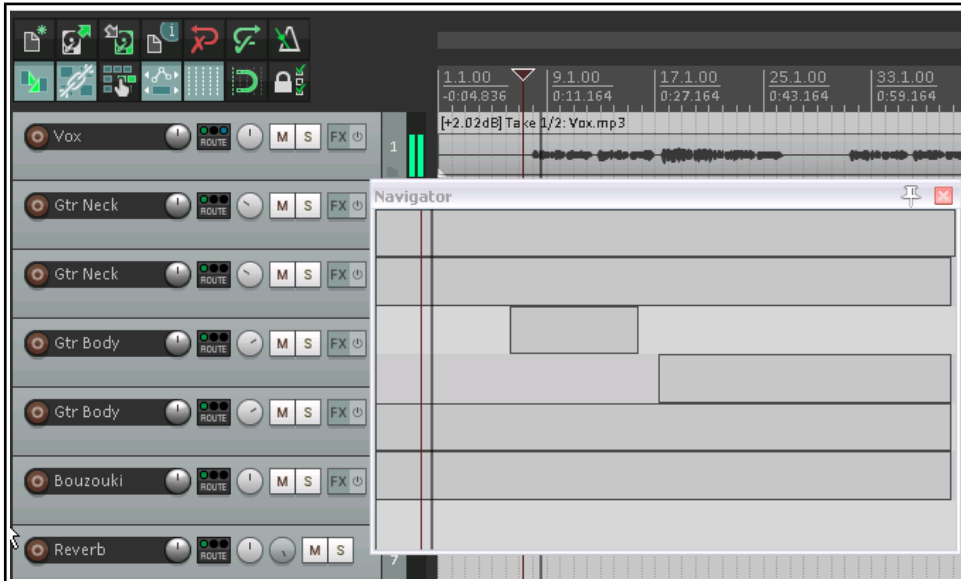

The REAPER Navigator shows you an overview of your project. It can be useful to display this when you are zooming closely on an area of your project.

To display the Navigator, choose the **View, Navigator** command. The keys **Ctrl Alt V** can be used to toggle the Navigator display on and off.

You can also use the Navigator window to scroll thru your

project. Simply position the mouse over the box within the navigator window that represents the on-screen area of your project. Then hold down the left mouse button, and click and drag to scroll the display. Release the mouse button when finished. Other ways of using the **Navigator** are:

Activity	Method
Define new area to be displayed in REAPER workspace.	Hold down right mouse button, drag and release
Reposition rectangle and workspace display area.	Left click mouse
Reposition and relocate play cursor.	Ctrl Left Click
Use as in workspace to scroll and/or zoom.	Mousewheel

2.12 Track FX Basics

Track FX (JS, VST, VST3 and Direct X as well as VSTi, VST3i and DXi, and, for Mac users, AU) can be added to any track by directly inserting the FX into the FX Chain for the required track. A good selection of audio FX plug-ins is supplied with REAPER, including Jesuonic and Cockos effects. We'll be taking a closer look at many of these individually later in this User

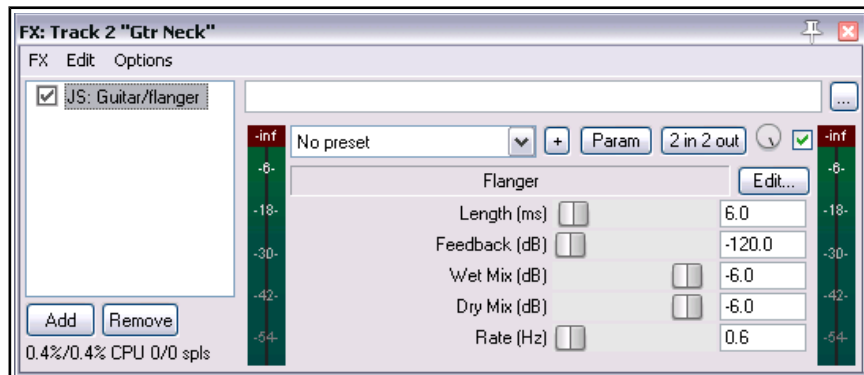

Guide, especially in Chapters 5 and 14. REAPER also includes a bundle of programmable video effects, which we will look at in Chapter 20. For now, let's just focus on some general aspects of how audio FX fit in to the REAPER scheme of things. To use any of these FX, simply follow this procedure:

1. Click on the FX Button in the Track Control Panel of the track to which you want to add the FX. This opens the FX window for that track. If the Add FX window (see below) is not automatically displayed, click on the **Add** button to open it.
2. Select a category, e.g. All Plug-ins, DX, VST, JS, Cockos. All FX in that category will be listed.
3. Double click on the required FX name.
4. To add more FX, click on the **Add** button in the Track FX window, then repeat steps 2 and 3 above.

Note: When you add any plug-in to any track's FX chain, that plug-in will then be displayed in the FX Browser's **Recently Used** FX folder.

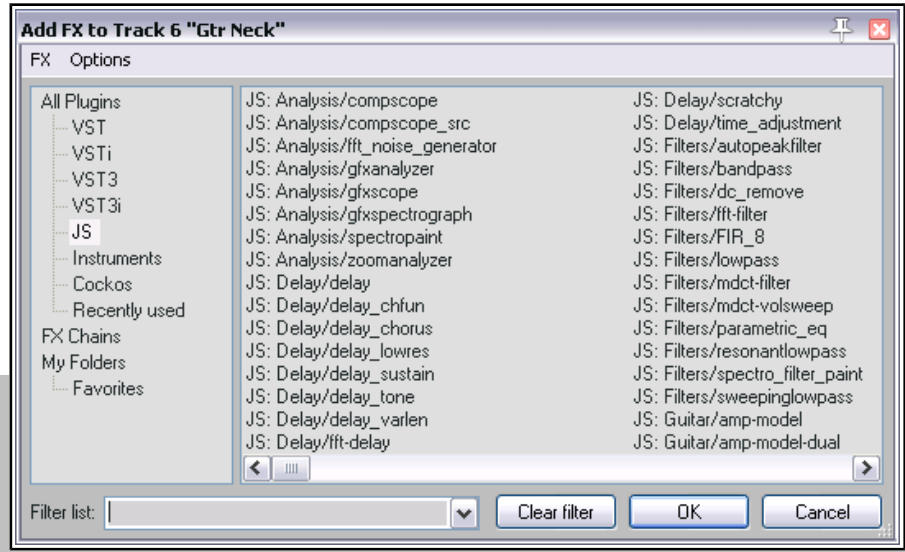

2.13 Using the Supplied FX Presets

The excellent FX that are shipped with REAPER can be used to improve the sound of your tracks. The use of these FX is a huge topic. You will find many examples in Chapters 14, 15 and 16 of this User Guide. For more detailed information and more advanced examples, you should consider obtaining a copy of **ReaMix: Breaking the Barriers with REAPER** which is available from the REAPER Bookstore at <http://stores.lulu.com/store.php?fAcctID=1374784>

However, as a means of getting started you might wish to explore some of the presets that come with these plug-ins. For example, **Cockos ReaDelay** includes presets which as a starting point you can try with your various tracks. Simply display the drop down list and select the item that you want (example shown right).

Most of the Cockos Rea series of plug-ins include a number of presets. You can explore these for yourself to discover what is available. Of course, you can also make any adjustments and changes to these that you like, in order to customize them more precisely to your own needs.

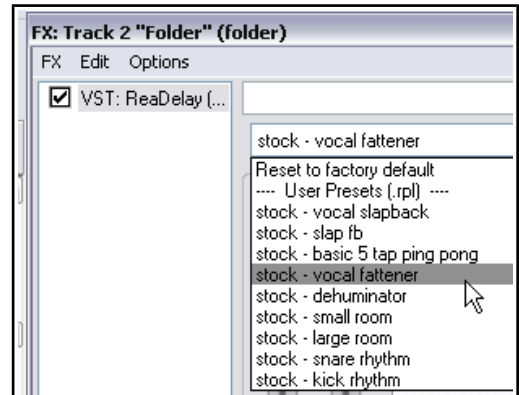

To set any FX preset as the default for that FX

1. Select the required preset from the drop down list.
2. Click on the **+** button to the right of the list and choose **Save preset as default...** from the menu.
3. Type your own name for the preset and click on **OK**.

As well as the presets supplied with REAPER, you can download further sets by visiting <http://stash.reaper.fm/> and following the link to **FX Preset Libraries**.

To import downloaded presets into REAPER, follow this sequence:

1. Insert an instance of the plug-in into any track.
2. Click on the **+** button (just left of the **Param** button in the FX Chain window).
3. Choose **Import Preset Library**.
4. Navigate to and select the required file then click on **Open**.

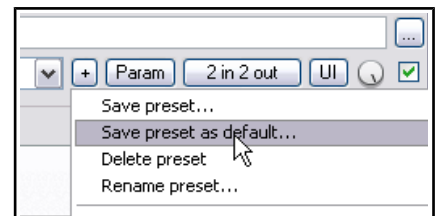

Up and Running: A REAPER User Guide v 5.24

To select a preset when loading an FX

1. Open the track FX window and click on the **Add** button.
2. select the required category (e.g. Cockos).
3. Right click on the required FX (e.g. ReaEQ).
4. From the context menu, choose **presets** then select the required preset (e.g. Intimate female vocal).

2.14 Controlling Track FX

REAPER provides you with a number of tools to help you manage your Track FX. For example, you can:

- Change the order in which they are applied.
- Copy or move any FX from one track to another.
- Save (and retrieve) any sequence of FX as a chain that can be easily inserted into other tracks.
- Bypass individual FX or an entire FX chain.
- Specify a default set of FX to be automatically inserted into new tracks for your project.

Task	Method
Dock the FX Chain	Choose the FX, Dock FX Window in Docker command.
Adjust the values for Track FX parameters	Drag with the mouse, or scroll the mouse wheel over, the fader that controls the value of the parameter that you wish to change. For fine adjustments, hold down the Ctrl key while you do this. If you prefer, select the control with the mouse, then use the up/down keys on your keyboard.
Adjust the wet/dry mix of any FX	Select the plug-in in the FX chain, then use the mouse to adjust the small rotary control next to the UI button on REAPER's FX window interface, as shown here.  A setting of 100% equals completely wet: a setting of 0% represents completely dry.
Change Track FX Order for a track	Drag and drop FX name up or down within the Track FX window.
Float an FX window	Double-click on the FX name in the FX Chain window (toggles). The title bar of the floated window will display the track name, the FX name, and its place in the track FX chain. For example: VST: ReaEQ, Track 1 "Vocal" [2/3] , i.e. the 2nd FX in a chain of 3.
Keep FX or Add FX window on top	Click on the pin symbol at right of title bar.
Close a floating FX window	Double-click on FX window title bar.
Copy an FX from one track to another.	Hold down Ctrl , drag the FX from the source track FX window and drop on the track panel for any other track.
Move an FX from one track to another.	Hold down Alt , drag the FX from the source track FX window and drop on the track panel for any other track.
Rename an FX Instance	Select the FX name in the FX Chain and press F2 .
Bypass an FX	Untick either the check box left of the FX name in the Track FX window or the check box in the top right corner of the FX window.
Replace one FX with another	Select the FX in the FX chain, then press R . In the Replace FX window (now displayed) double-click on the required replacement FX. Any existing routing configuration will be preserved.
Make the current Track FX the default for new tracks	Within the Track FX window, choose FX, Save Chain as default for new tracks .

Task	Method
Remove an FX from a track	Select the FX name within the Track FX window then click on the Remove button.
Remove all FX from a track	Hold Alt while clicking on the track's FX button in the TCP.
Search for an FX	Enter text in the Filter List at the bottom of the FX window.
Save the current sequence of Track FX as a chain	In the Track FX window, choose the FX, Save FX Chain command. FX parameter settings are saved with the chain.
Save selected Track FX as a chain	Select the names of the FX to be included in the chain (use Ctrl key while clicking the mouse), then choose FX, Save Selected FX as Chain
Retrieve an existing previously saved FX Chain	Within the Track FX window, choose FX, Add FX Chain command, or within the TCP right-click over the FX button and select Add FX Chain from the menu.
Load your default FX Chain	Within the Track FX window, choose FX, Load Default Track Chain from the menu.
Access the FX Preferences settings	Within the Track FX window, choose the Options, FX Plug-in Settings command. These are discussed in Chapter 22.
Bypass all FX for a track	In the Track Control Panel, click on the FX Enable/Disable toggle button. Click again to reverse this. <div style="text-align: right;">  </div>

2.15 Creating a Default FX Chain

If you have used other DAW software such as Sonar, you might be used to having an EQ Plug-In automatically inserted for you in every track. REAPER allows you to do this by creating a default FX chain which is then automatically applied to every new track that you create. Of course, this default chain can contain any FX that you wish. To do this, you simply follow this procedure:

- Open the FX Window for any track.
- Add as many FX you require.
- From the FX window menu, choose **FX then Save chain as default for new tracks**.

Tip: If you switch the FX to bypass mode before saving your FX chain, then the FX chain will be saved in bypass mode. This means that the FX in your new tracks will not require any CPU usage until such time as you open the FX window and enable them.

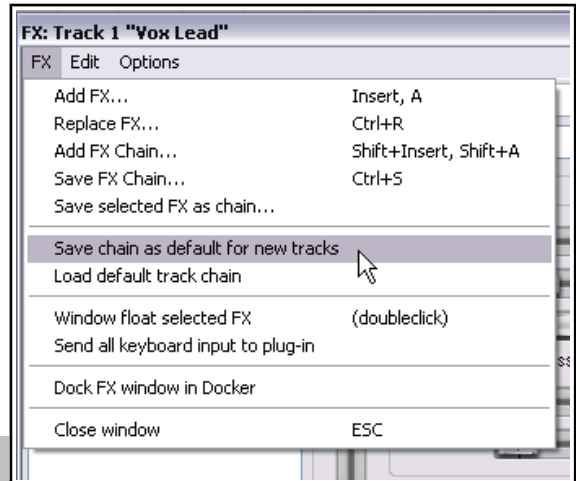

Example

In this example, we will create a default FX chain that consists of ReaEQ and ReaComp, both set to bypass mode.

1. Open any project file and add a new track at the end. We will use this track to create our FX chain.
2. Click on the **FX** button for this track to open the FX Window.
3. In the first (left) column of the Add FX window, click on **Cockos**.
4. Select in turn, first **ReaEQ (Cockos)** and then **ReaComp (Cockos)**. In each case, either use the **OK** button to add the plug-in to the track FX chain, or drag and drop them into the chain.
5. Make sure that both these FX are unticked – this sets them to bypass.

To Create the Bus and add the FX to it:

- Select track 4 (in the Track Control Panel).
- To insert a new track either choose the **Track, Insert New Track** command, or press **Ctrl ,T** or double click in the vacant track control panel area beneath the last track.
- To name this new track, click in the area where the name is to go, type **FX Bus** then press **Enter**.
- To insert the Chorus FX into this bus, click on the bus's **FX** button. From the list of plug-in types, select Jesusonic, then in the list of plug-ins double click on **JS: Guitar/Chorus**. Close the Bus FX window.

To Create Sends from the two guitar tracks to the Bus:

- Select the two guitar tracks in the TCP. Right-click over the **ROUTE** button for either of these tracks.
- From the context menu, choose **Sends** then **Track 5: FX Bus**.

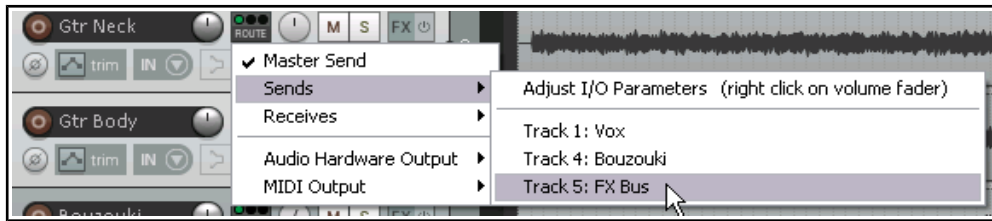

Note that for every send there is an equivalent receive, and vice versa. For example, if you now open the Routing window for Track 5 (click on the track's ROUTE button) you will see that it has two receives, one from each guitar track. You'll learn more about REAPER's routing later in this chapter (Routing Essentials) as well as in Chapter 5 and 15.

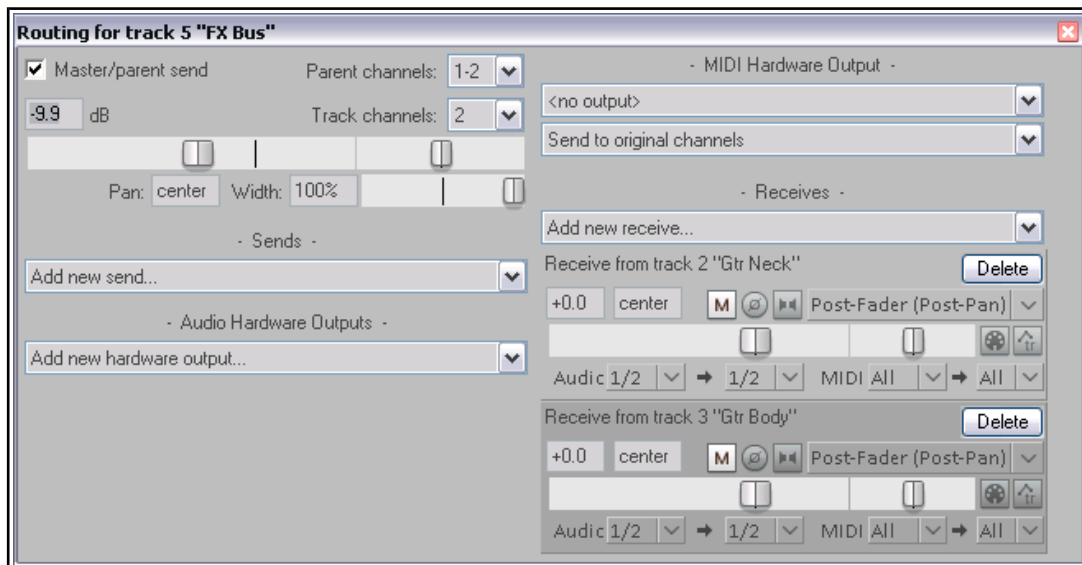

Making Adjustments

When you now play the song, you'll probably find that there's more chorus on the guitar tracks than you would like. There are four main ways to adjust this. Experiment until you find what gives you the results you want:

1. Adjust the chorus FX parameters. In this case, you could lower the amount of Wet signal in the mix.
2. Adjust the levels of one or both of the receives in the FX bus routing window.
3. Display the routing window for either guitar track and adjust the send levels for that track.
4. Adjust output volume fader for the track called **FX Bus**.

Up and Running: A REAPER User Guide v 5.24

Speed Tips

In Order To Do This ...	Do This
Toggle on/off send from track to Master	Hold Alt while clicking on ROUTING button. Works with single track or multiple track selection.
Create a quick send on the fly from one track to another.	Drag and drop from ROUTING button of send track to the track panel of receive track. This can also be done in the mixer view. See Chapter 11 for a description of the full range of options.
Send a track's output direct to any hardware output.	Right-click on ROUTING button and select Audio Hardware Output or MIDI output (as required) then choose from the sub-menu. This can be used with a track selection and is independent of the track's master send status.

2.17 Analyzing FX Performance

FX plug-ins can impose a heavy load on your computer's CPU. To help you overcome this, you can use the **Performance Meter** to closely monitor your FX in the following ways:

- You can check how much CPU is being used by the FX in your various tracks and in the master.
- You can disable and enable FX chains for individual tracks, quickly, easily and conveniently, all together in one place.
- You can toggle on and off the mute status for your tracks, again all in one convenient place.

To display the Performance Meter, press **Ctrl Alt P**, or use the **View, Performance Meter** command.

Example

In the example shown (right), the Master track with 1 plug-in is using 0.14% and the Vox, also with one plug-in, is using 0.05%.

If any track shows an unexpectedly high reading, you can examine the FX for this track, to help you to identify the reason for this. To open a track FX chain, double click on the track name or number in the Performance Meter window.

This feature is useful if you have a large number of tracks in your project. You can use the Performance Meter window to browse thru your project file, checking it track by track, without having to scroll or navigate thru Track View. You can of course also toggle FX Bypass for any track, selection of tracks, or all tracks in the **Track View** or **Mixer View**. The table below summarises these options.

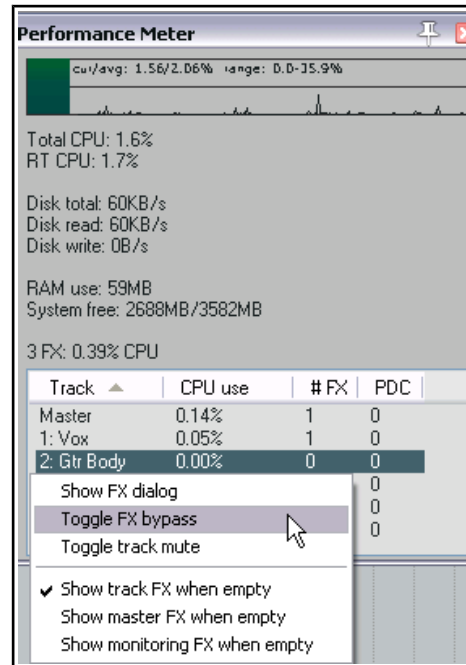

In order to do this ...	In Mixer or Track View, do this ...
Toggle FX Bypass On/Off for that track.	Click the FX Bypass button for any track.
Toggle FX Bypass On/Off for all tracks in the selection.	Select a number of tracks (Ctrl Click) then click the FX Bypass button for any track in the selection.
Toggle FX Bypass On/Off for all tracks.	Hold Ctrl key while clicking FX Bypass button for any track.

In addition, the Performance Meter has two right click menus, each with a number of options (see above). The first is accessed by right clicking in the track list area.

In order to do this ...	In the Performance Meter window do this ...
Open FX Window for that track.	Right click on track name, choose Show FX Dialog .
Toggle FX Bypass On/Off.	Right click on track name, choose Toggle FX Bypass .
Toggle track mute for that track.	Right click over any track, choose Toggle Track Mute .

In order to do this ...	In the Performance Meter window do this ...
Show in/hide from Performance Meter track list tracks with no FX.	Right click on any track, enable/disable Show track FX when empty .
Show in/hide from Performance Meter master track/monitoring when these have no FX.	Right click on any track, enable/disable Show master FX when empty and/or Show monitoring FX when empty .

The other menu is used mostly to select what information you want shown in the window. Right click anywhere in the main Performance Meter area to display this. You can also use this menu to move the window to the docker.

Tip: You can select several tracks – using **Ctrl Click** – then right click over any of the selected track numbers in the Performance Meter window to Toggle FX bypass and/or Track Mute status for all tracks in the selection.

Note: You can find more information about the REAPER Performance Meter in Section 19 of this guide, Further Customizing REAPER.

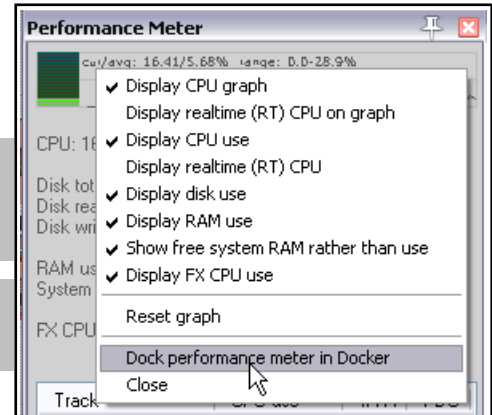

2.18 Selections and Loops

Often you will want to work with just a part of your project for a while. In order to do this, first check the **Options** menu to see if **Loop Points Linked to Time Selection** is enabled. If it is enabled (ticked) then making a time selection and defining a loop are the same thing. If it is disabled (not ticked) then making a time selection and defining a loop become two different things. Whichever is the case, you can define your loop area by clicking and dragging along the timeline.

- Stop the playback at or near the point where you want your loop to begin (or click your mouse in the background area) to move the Edit Cursor there.
- Place your mouse over the **Timeline** (just above the first track), then click and drag along the timeline, releasing the mouse to define the exact area that you want to loop. The effect of this is illustrated above. Notice that the start and end of the loop are marked by two small triangles. *If when you attempt this, the selection snaps outwards to define a larger area than you want, then REAPER has snapping enabled.* Snapping will be discussed in detail in Chapter 7, but for now you can use the shortcut keys **Alt S** to toggle this feature on and off.



Tip: To set the loop selection to match a media item, hold **Ctrl** while you double click on that item. To set the time selection to match a media item, hold **Shift** while you double-click on the item.

Now when you play the project, provided that the loop (toggle repeat) button on the transport bar has been engaged, it will replay over again the area selected for your Loop. This is known as the repeat function. If loop points are linked to time selection, the start time, finish time and duration of the selection are also shown on the **Transport Bar**. In any event, pressing the **R** key toggles this repeat function on and off. There is also the option (under **Options, Preferences** on the **Playback** page) to stop playback at the end of a loop when the repeat function is disabled.

To change the region defined as your loop, simply repeat the original procedure. To clear the loop altogether, without defining a new one, just press the **Escape** key.

If loop points are not linked to the time selection, you can define a time selection by clicking and dragging in the space underneath or between the media items, in the arrange view background area. An example of this is shown below.



Up and Running: A REAPER User Guide v 5.24

Right clicking on the Timeline then gives you a menu of commands which you can apply to a time selection, including **Zoom Selection**.

You can also use this menu to change the units used on the timeline – for example,

Minutes:Seconds, Measures:Beats, Measures:Beats and Minutes:Seconds,

Measures.Beats (minimal), Measures.Beats (minimal) and Minutes/Seconds (as in the example above right), **Seconds, Samples, Hours:Minutes:Seconds:Frames** or **Absolute Frames**.

Many of these commands are shown in the illustration (right) - enough to help you to understand how

important working with time selections is in REAPER. The other commands on this menu will be discussed elsewhere in this User Guide, as the need arises. These are features that you are likely to find useful when editing your files.

Incidentally, to zoom out of a time selection and restore a whole project length to view, press **Ctrl PgDown**.

There's more about loops and time selections elsewhere in this guide, e.g. Chapters 6 and 8.

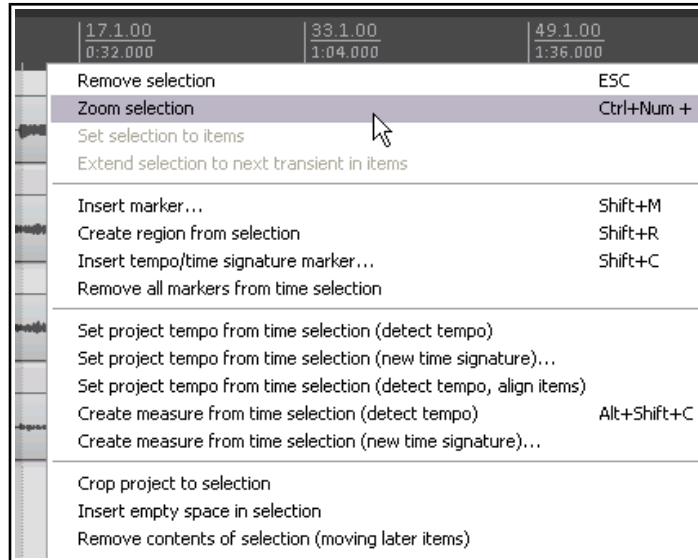
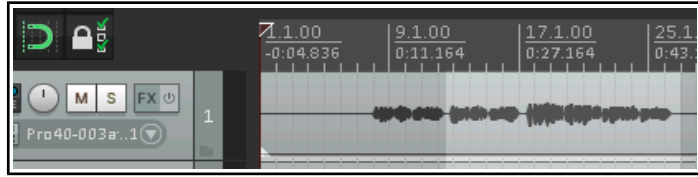

2.19 Managing Time and Loop Selections

In the previous section you learnt how to click and drag within an empty area of the track view to define a time selection. This may or may not also change the loop selection, depending on your **Options, Loop points**

linked to time selection setting. As you progress thru this User Guide, you will see that time selection plays an important role in REAPER, for example when it comes to editing your media items. You'll probably find at first that it's too easy to perhaps select too large an area, or to miss part of the area that you intended to select.

To modify a loop selection using the mouse, hover the mouse over the edge at the start or finish of the loop selection on the timeline, then click and drag left or right. Dragging left from the start of the selected area extends the selection left, dragging right shortens it. Dragging right from the finish of the selected area extends it to the right, dragging left shortens it. Holding **Ctrl** while you do this cause any snap settings to be ignored.

To move a loop selection, hold the mouse over the selected area on the time line, then hold down **Shift** while clicking and dragging the mouse left or right.

You can also modify a time selection by first clicking then scrolling the mousewheel over the Selection area of the **Transport Bar**. Scroll over the start area to adjust start time, end area to adjust end time, or over the length of selection area to move the entire selection. If you wish, you can enter actual times in the start and end time boxes. There are also several keyboard shortcuts you can use for managing **Time Selections**, summarised below. If loop points are linked to the time selection, then the loop area will also be modified.

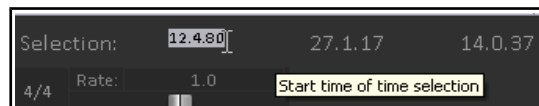

Function	Keystroke
Nudge Entire Time Selection left a little.	, (comma)
Nudge Entire Time Selection right a little.	. (period or full stop)
Extend Time Selection to left by nudging left edge left a little.	Ctrl ,
Shrink Time Selection to right by nudging left edge right a little.	Ctrl .

Function	Keystroke
Shrink Time Selection from right by nudging right edge left a little.	Ctrl Alt ,
Extend Time Selection from left by nudging right edge right a little.	Ctrl Alt .
Move Time Selection left by time selection length.	Shift ,
Move Time Selection right by time selection length.	Shift .
Copy portions of selected media items in Time Selection.	Ctrl Shift C
Remove Time Selection.	Esc

If you wish, you can use the keyboard rather than the mouse to define your time selections. First you need to position the cursor at either the start or the end of the loop, then use one of these:

Function	Keystroke
Drag cursor to the left and create time selection.	Shift Left Arrow
Drag cursor to the right and create time selection.	Shift Right Arrow

The following keystrokes can be used to zoom when you are working with a time selection:

Function	Keystroke
Zoom to Time Selection.	Ctrl PageUp
Zoom back to Project.	Ctrl PageDown

Tip: If you are unable to position your cursor exactly where you wish when creating a loop selection, it may be that you have snapping enabled. **Alt S** will toggle snapping status on and off.

2.20 Navigating by Jumping

You can jump to any point on the timeline using the **View, Go To, Jump To** command, or by using the keyboard shortcut **Ctrl J**. In specifying the place to jump to, you should use the same format as is used on the timeline. In the example used here, the timeline displays Measures and below it Minutes and Seconds. You could therefore use either format, e.g. **33.1** or **1:04**.

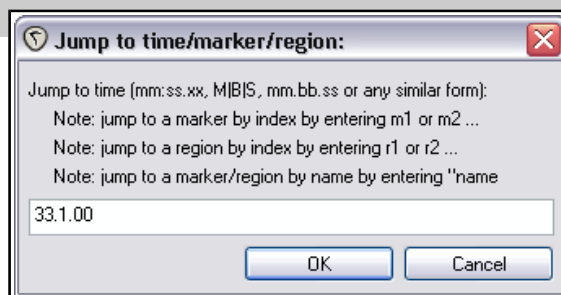

If your project uses markers and/or regions, you can use this box to jump straight to any maker or region. For example, typing M1 will cause it to jump to marker 1, R2 to jump to the start of region 2, and so on. Markers and regions are explored in Chapter 9.

Tip: Another easy way to open the Jump to dialog box is to double-click on the time on the transport bar.

2.21 Time and Loop Selections and the Transport Bar

There are two special ways in which the transport bar can be used with a loop selection or a time selection.

In order to do this you should do this
Repeatedly play the selection over and over	Make the required loop selection, make sure Repeat is enabled (the button next to Record on the Transport Bar), position the play cursor within the loop and press Space .
Play back project skipping over time selection	Make the required time selection and position the play cursor anywhere before the start of that selection. Press Alt Space .

2.22 Item Names, Buttons and Icons

Depending on **Appearance, Media** preference settings, you may (or may not) see item names displayed above the media item rather than on it (see right). You might also see some media item icons (or buttons). You'll learn more about this when we examine media items in Chapter 7.



2.23 REAPER Routing Essentials

This section will teach you more about an important core functions of REAPER – **Routing**. Routing lets you ensure that your media (audio and/or MIDI) are directed to where you want them to go, so that your project can be heard exactly as you want it to be heard. You were introduced to some basic examples earlier in this chapter, when we looked at creating and using an FX bus. Routing can be very simple or extremely complex – and anything in between. This section introduces you to basic routing concepts. More complex routing options will be covered later in this Chapter, also in Chapters 4 and 15, and elsewhere.

Each track includes a **Routing Button** in its panel toolbar (shown right). Hovering the mouse over this button will display a tool tip. This will also show any sends and/or receives already associated with that track. Clicking the button causes the routing window for that track to be displayed. To close the track routing window, either press the **Escape** key, or click on the little **X** in the top right corner of the window, or click anywhere outside the window.



The actual contents of your Track Routing window will vary according to your project structure and your DAW hardware setup (e.g. sound card and audio devices, MIDI devices etc.).

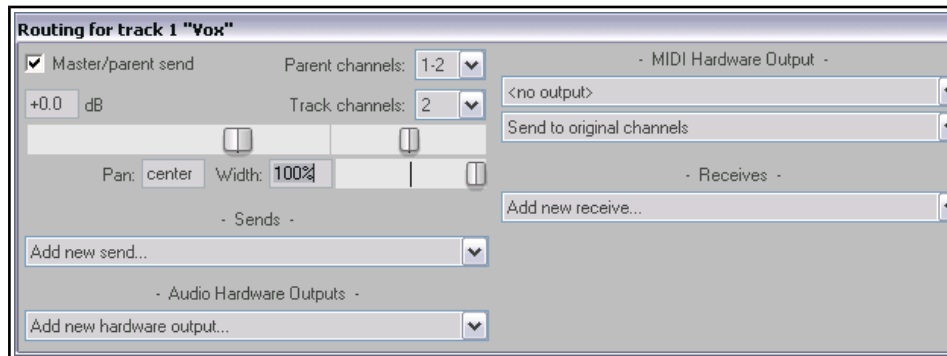

Depending on the nature of your project, your display should be *similar* to that shown above, but not necessarily identical. Notice in particular:

- **Master/Parent Send** – Enabling this ensures that the track's output will be directed to the Master. In the sample files provided, you will want to direct the output of all tracks directly to the Master, as shown for Track 1 (above). If in doubt, leave this item enabled.
- **Sends** – In the FX Bus example earlier in this chapter you created sends. A track's output can be routed via a send from any track to any other track or tracks. This topic will be covered in more detail later.
- **Audio Hardware Outputs** – in addition to (or instead of) directing output to your Master Bus, you can also direct output of any track directly to Hardware Outputs on your audio device. If your audio device has multiple outputs, this can be useful, for example, for creating a separate headphone mix, or as series of separate headphone mixes.
- **MIDI Hardware Output** – Use this option to direct MIDI output to an external device or to the Microsoft GS Wavetable Synth.
- **Receives** – For every send (source) track there will be a receive (destination) track. In the earlier example, the FX bus included two receives, one from each of the two guitar tracks in that project file.
- Notice (picture below) that when you create a send, you are presented with volume and pan faders which can be used to control this. You can also specify whether to send audio output, MIDI output, or both.

- Whenever you select any listed track, audio hardware output or MIDI device to be used for a track's routing, controls such as Level and Pan are automatically added to this interface.

When you create a new project, by default the output of each new track is routed to the Master track and from there to the output of your sound card. If that is all you need, you do not need to study the routing options right now. However, understanding REAPER's routing capabilities will almost certainly enable you at some stage to get more benefits from the program.

The illustration below shows an example of the Track Routing Window for a track for which both a **send** and a **receive** have been created. You will be shown how to do this later in this User Guide, starting at Chapter 5.

The illustration below shows an example of the Track Routing Window for a track for which both a **send** and a **receive** have been created. You will be shown how to do this later in this User Guide, starting at Chapter 5.

Approach track routing gently at first: it is very powerful. The early chapters of this User Guide will take you thru the basics of track routing. After you have mastered these, you will find more complex examples elsewhere in this User Guide, especially in Chapter 17.

Note: Sends and Receives can be any of three types. These are

Post Fader (Post Pan), **Pre-Fader (Post FX)** and **Pre FX**. The differences will be discussed in Chapter 17. Meanwhile, if in doubt accept the default option **Post-Fader (Post Pan)**. See also the flow charts at the end of Chapter 6.

Tip: Drag and drop routing. A quick way to create a send from one track to another is to drag and drop from the route button on the source track to the destination track. This is explained in detail in Chapter 17.

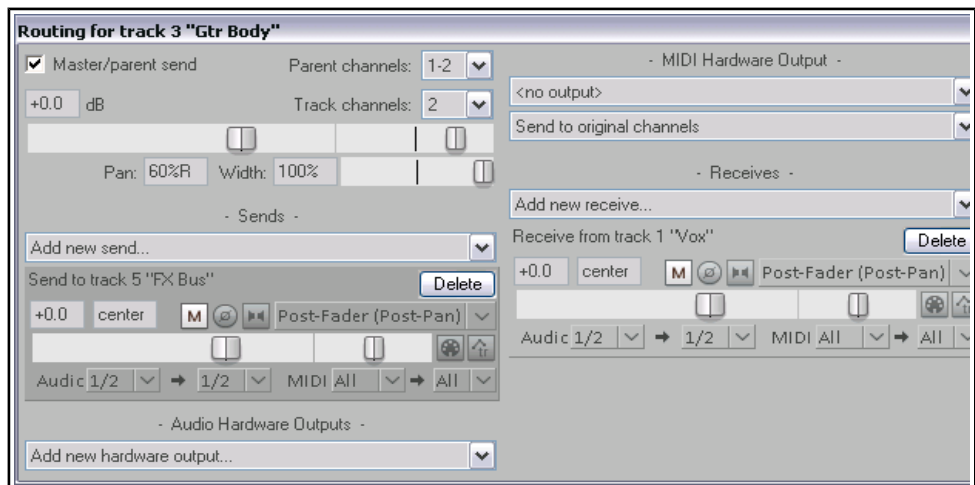
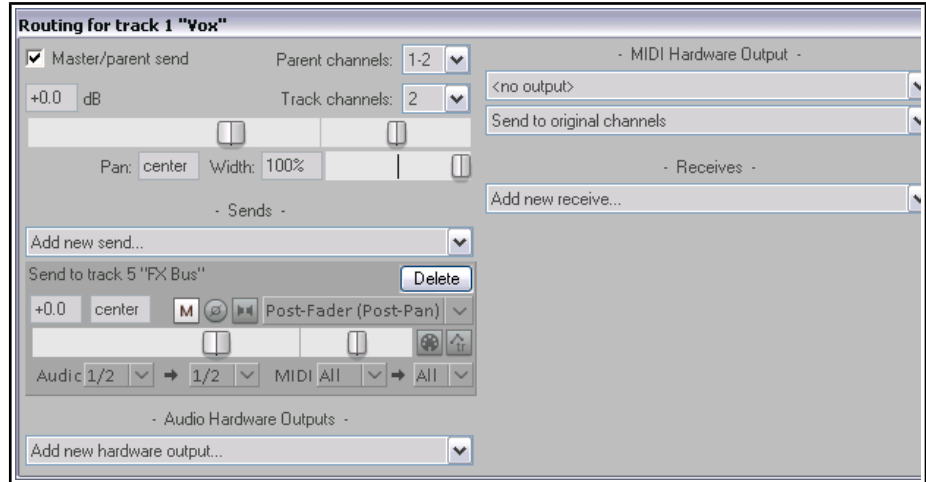

2.24 The Routing Matrix

REAPER's Routing Matrix is a "one stop" window where you can manage and arrange a project's entire routing structures. For example, you can add and delete sends and receives and manage their various parameter controls, such as volume and pan.

Press **Alt R** to display the routing matrix. For the project file **All Through The Night with Bus** it should resemble that shown right: of course your hardware outputs will not be the same.

Observe the cell in the matrix where the **Gtr Body** row intersects with the **FX Bus** column. It contains two small blobs.

By right clicking over this cell, you can cause the controls to be displayed which determine how the signal from the Gtr Body track is sent to the FX Bus (see illustration below).

Simplifying the Routing Matrix Display

If your sound card has multiple outputs, then by default, REAPER's Routing Matrix will display multiple permutations of paired outputs, including several that you may feel that you do not need. By default REAPER will allow you to use any two consecutively numbered audio outputs as a stereo pair. It is quite likely that you may want to use, for example, outputs 1 and 2 as one pair (perhaps for your speakers) and outputs 3 and 4 as another pair (perhaps for your headphone amp). However, it would be unusual to want to use outputs 2 and 3 together as a pair.

If you wish, you can prevent these unwanted combinations from being displayed by choosing the **Options, Preferences** command, then selecting the **Audio** settings page. This includes a **Channel naming** section, where you can turn off the option to **Show non-standard stereo channel pairs** (see right). If for some reason you did wish to direct your output to any non-standard pair, you could still do so by selecting each of them individually on the matrix.

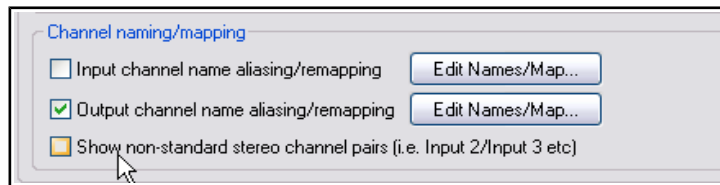
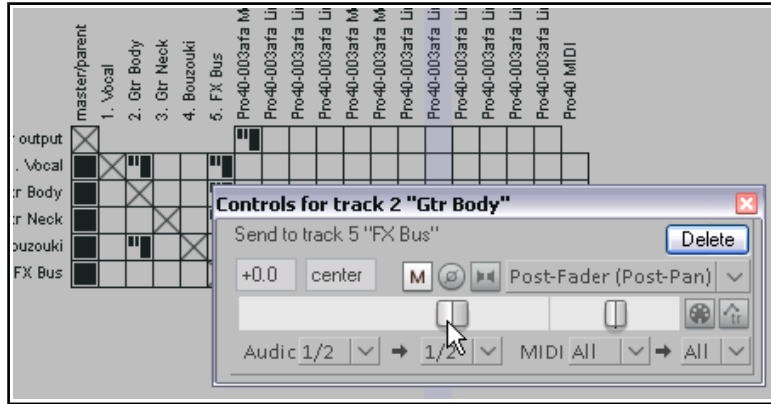

2.25 Docking and Floating

Too many views on the screen at once creates clutter. That's when the Docker becomes useful. Right clicking over the title bar or background area of most windows causes a context menu to be displayed which will offer a list of choices relevant to that window. Usually their purpose will be obvious. This will include an option **Dock in Docker**.

When a number of windows are docked, at the foot of the Docker you will see a series of Tabs. These are used to select which item is displayed by the Docker at any time. In the illustration here, the Docker includes several items. Notice also that:

- If you close a Window, next time it opens its docking status will be the same as when it was closed. If a Window is docked when it is closed, next time it is opened it will still be docked.
- To undock a window, right click over the background or tab area of the window and deselect the **Dock in Docker** option.
- The Docker can itself be attached to the main window or detached and floated. Click over the small exclamation mark in the bottom left corner of the Docker and use the option to **Attach Docker to Main Window** to toggle.

By default the docker will be attached to the bottom of the main window, but you can use the same menu to change this position to left, top or right.

- Clicking over the exclamation mark after detaching the Docker from the Main Menu will also give you access to the **Set Opacity** feature. This can be used to ensure that when floated and not in focus, the Docker is transparent. Opacity can be set between 25% and 100%.

Tip: The keyboard shortcut **Alt D** can be used as a toggle to show or hide the Docker or Dockers.

More experienced users might be interested to know that if you wish you can work with multiple dockers. This topic is covered in Chapter 12, Project Management Features.

As an alternative to docking windows, you might consider the toggle command **View, Show/hide all floating windows** as a method of handling screen clutter. Another useful command can be **View, Cascade all floating windows**.

2.26 The Undo History Window

REAPER's Undo feature is user friendly and very powerful. The **View, Undo History** command (or use **Ctrl Alt Z**) toggles open and closed the **Undo History Window**. You can double click on any event displayed in that window to go back to that point.

The **General** settings page under **Options, Preferences** includes a section which you can use to determine the behavior of the Undo History. In particular, you can:

- Specify the maximum amount of memory to be allocated to Undo. Setting this to zero will effectively disable this feature.
- Specify whether item, track, envelope point and/or time selection and/or changes in cursor positions are to be included in the Undo History.
- Ensure that if the allocated Undo storage area becomes full, the most recent actions will be retained in the Undo History.
- **Save your Undo History with the Project File** and ensure that this file is loaded with the project. This means that even after retrieving the project file at some later date, you will still be able to revert the project to an earlier state if you wish.
- **Store multiple undo/redo paths.** Within the Undo History window you can even store alternate sequences of commands and actions, then switch between them!

Tip: On the **Appearance** page of your Preferences settings, you can enable or disable the option **Show last undo point in menu bar**. If you enable this, your last undoable action is shown after the last command on the menu bar. You can click on this at any time to open and display the Undo History window. Click a second time to close this window.

Note also that the Undo History window is dockable. To do this (as with most other windows), right-click on the title bar and choose **Dock in Docker** from the context menu.

2.27 Keeping a Window on Top

The small pin shown on the right of the title bar of most windows (just before the **X**) can be used to pin a window to keep it on top. Click on this to toggle its on top status. When the pin is shown in the down position, the window is locked on top.

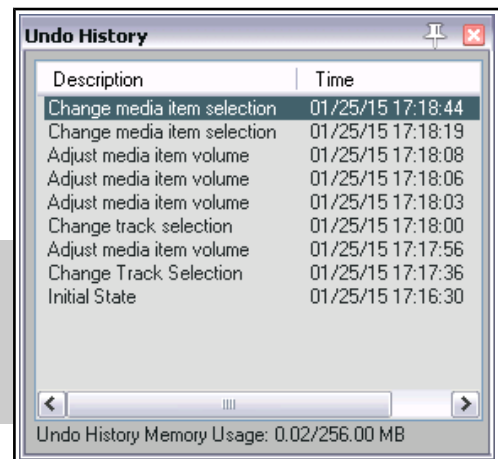
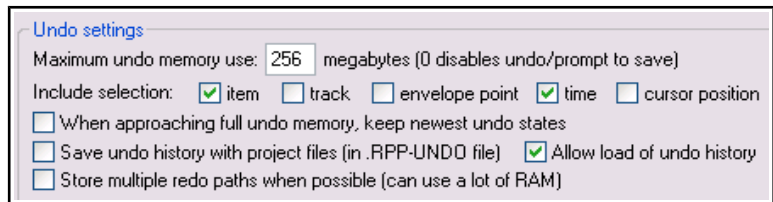
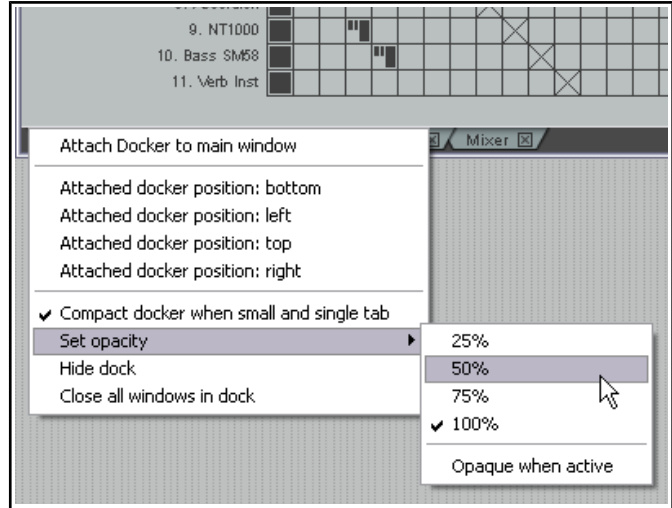

2.28 Multiple Project Tabs

REAPER lets you keep more than one project open at the same time, using multiple project tabs. This makes it easy for you to jump between different projects if you are working on more than one song, or to move or copy media items (audio and/or MIDI) from one project to another.

To create a new project tab when you already have one file open, simply use the **File, New Project Tab** command (or press **Ctrl Alt N**). A new tab will be opened (labelled **Unsaved**), but the previous project will also remain open on a different tab. You can jump between projects simply clicking on the tab (see below).

To open a file in a particular project tab, simply select that tab, then use the **File, Open Project** command in the usual way. To open it in a new project tab, simply select this option from the dialog box when opening the project. You may have as many projects open as you wish. Right click over any project tab to show the project tab menu. The commands are:

New project tab, This inserts a new tab.

Close project. Closes the current project and the tab with it. You can also do this by clicking on the **X** at the left hand end of the project tab.

Close all projects but current. Closes all project tabs except current one.

Close all projects. Closes all open projects.

Always show project tabs. Shows project tabs, even if only one project is currently open (toggle).

Show project tabs on left side of window: Displays tabs on left of window instead of top (toggle).

Hide background project FX/MIDI windows. Ensures that when one of a number of open project tabs is selected, any open FX windows etc. belonging to other open projects are not displayed on top of it.

Run background projects. This allows you to play the project in one tab while working on another.

Run stopped background projects. Commences playback of projects in tabs not currently selected.

Play stopped background projects with active project: Causes background projects (open on other tabs) to be played with the current project. When this is enabled, you can also select **Synchronize play start times w/play background** projects. This will ensure that all open projects are played/stopped in synch.

These commands and **Offline background project media** are mutually exclusive.

Monitoring FX ... This opens the monitoring FX window for hardware output monitoring: see Chapter 6.

Tips: When working with multiple project tabs, they can be reordered using drag and drop. When using multiple project tabs, you can use the **File, Close All Projects** command to close all open projects at once. Note that the small **X** button used to close a project tab can be positioned to the left or the right: just drag and drop according to your preference.

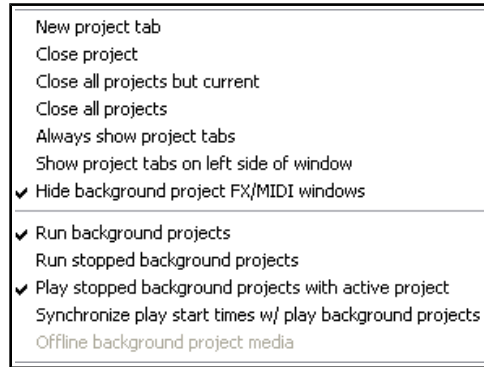

2.29 Opening Multiple Project Tabs Together

You can open several projects together at the same time, each in its own project tab, provided all the .RPP files are in the same folder.

Simply use the **File, Open project** command, then navigate to the required folder. Use **Ctrl Click** to build your selection, ensure **Open in new project tab** is ticked, then click on **Open**.

2.30 Managing the Play Cursor

By default, when a project is playing, pressing **Stop** (or **Spacebar**) will stop playback and return the play cursor to its previous starting position.

Pressing **Pause** (or **Enter**) will pause playback at the current play cursor position. You can also specify that the play cursor should be moved when you click on the Time Ruler, an empty area of any track or in the empty area below tracks.

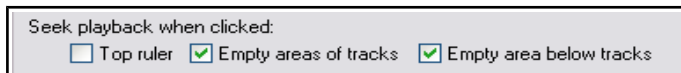

These three options can be enabled/disabled in your **Seek playback when clicked**. (**Options, Preferences, Audio, Seeking** settings).

3 Recording Audio and MIDI

This chapter will take you thru everything you need to know to get started with recording in REAPER. At the end of the chapter, you will find a helpful checklist.

3.1 Creating a New Project

To create a new project file, you can either use the **File, New Project** command, or press **Ctrl N**.

The **Project** page within the **Options, Preferences** dialog box can be used to determine how REAPER behaves each time you create a new project:

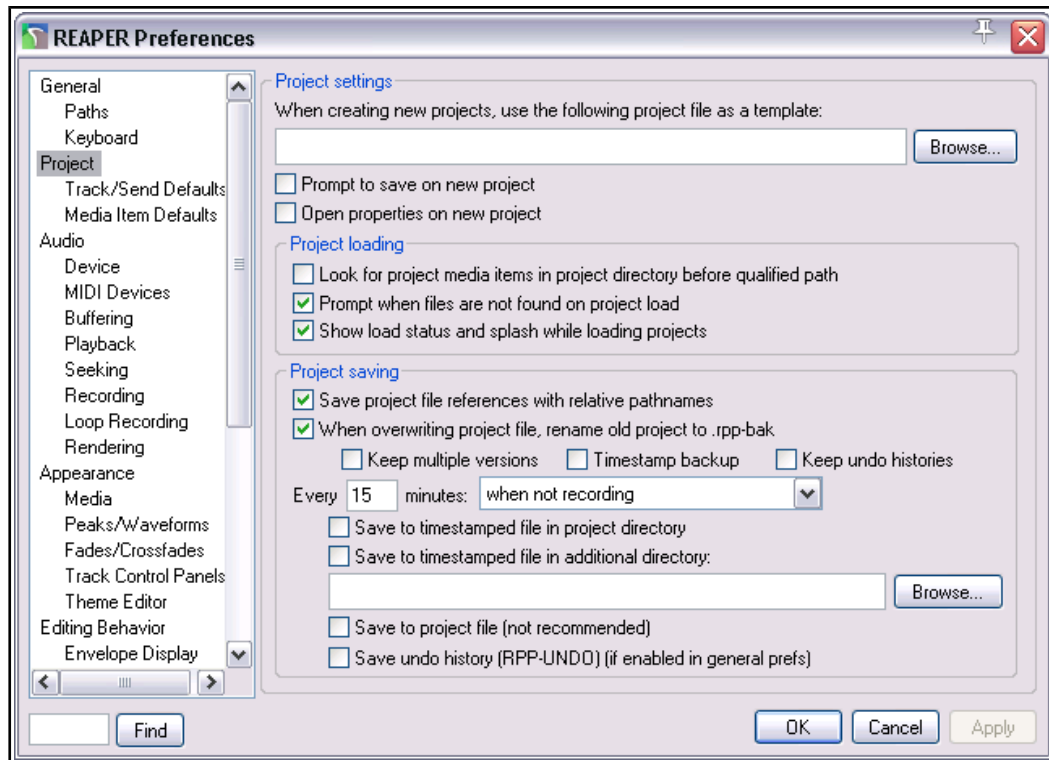

Amongst the most useful options on this screen are the following:

- **Use project file as a template.** This enables you to use an existing project file as a template for new projects. All tracks, HX, tracks, buses, routing etc. will be copied into the new file from the template file.
- **Prompt to save on new project.** If you enable this option, you will be prompted to save your new projects immediately they are created.
- **Open properties on new project.** If this option is selected, the **Project Options** dialog box will automatically be displayed every time you create a new project. This can help ensure that you select the correct recording format and other settings that you require.
- **Automatically create a backup each time your file is saved and overwritten.** This helps protect you against accidental loss of work.
- Whether to create and save **multiple project versions**. This feature is explained in Chapter 11.
- **Automatically save to a timestamped file at intervals you specify.** This can help to protect you from the consequences of an unforeseen circumstance such as a power outage or a computer crash. You can save these files to the **project directory** and/or an **additional directory**. You can also specify the frequency (in **minutes**) of automatic saving, and whether to apply this **when not recording, when stopped, or at any time**.

3.2 Setting Media Project Options

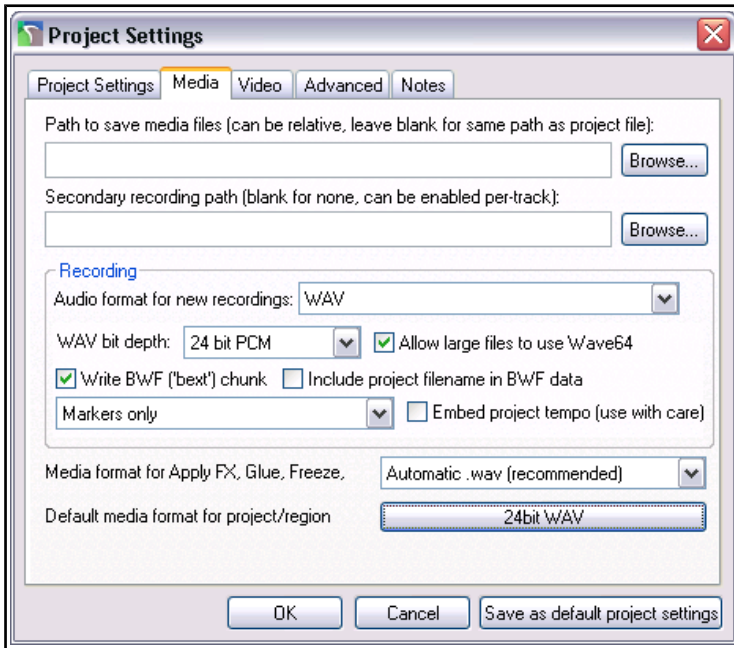

After creating a project file, you can display the **Project Settings** window – **Alt Enter** – to ensure that you are using your preferred **Media Settings**. In particular, check your preferred **audio** format. If you are not sure, for CD quality select **.WAV**, with settings similar to those shown here. If you wish later to use some other format (such as **.MP3**) you can render your files in that format.

The settings shown would be suitable when the output is to be rendered to CD audio. As a rule, 24 bit is preferred for recording. If the recording is to be finalised in DVD format rather than CD, you should consider a sample rate of 48000 instead of 44100. This is specified on the main **Project Settings** page.

Some people prefer 88200 for CD and 96000 for DVD. Be aware that increasing sample rate also increases media item file size and slows down processing.

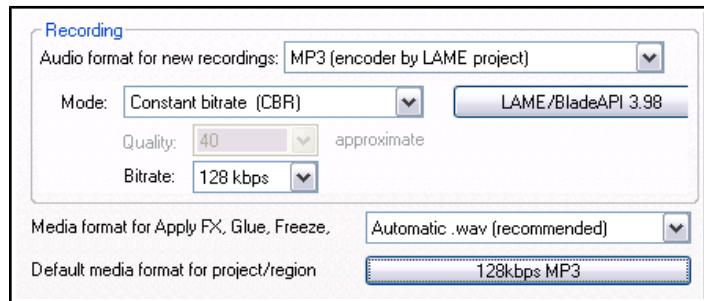

Other formats.

If you prefer, you can record using any of a number of available compressed formats, including MP3, OGG and WavPack. Choosing any of these will present you with further options appropriate to that format. For example, if you choose MP3 you will need also to specify your required bitrate.

There is also a drop down list where you choose to write as cues to your recorded

media files markers and regions, either one of these, or none of these, or only markers/regions whose name begins with #. See Chapter 9 for more about markers and regions.

3.3 Saving the Project File

After creating a file, use the **File, Save Project** command, or the keyboard shortcut **Ctrl S**, to save it. You will need to specify a project file name. When saving a new file you are offered a number of options. You can choose to **Create subdirectory for project**. If you also select **Copy all media into project directory** you may also specify a format for these items to be converted.

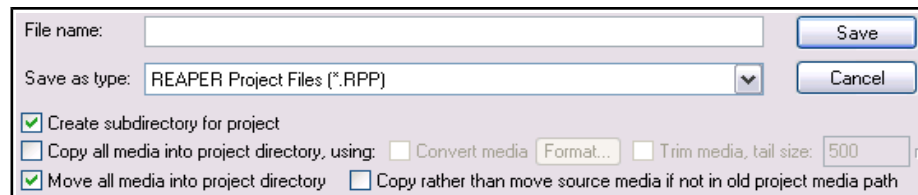

If you select **Move all media into project directory**, then by default all media files used by the project will be moved into the project subdirectory. Optionally you can ask to **Copy rather than move source media if not in old project media path**. You would be likely to choose this, for example, if your project uses files from a samples library, to ensure that the samples are not removed from the library.

You should also make sure that you get into the habit of frequently resaving your project after making changes. The easiest way to do this is simply to press **Ctrl S**.

3.4 Creating and Naming Tracks

After creating a new project file, the next thing you will want to do is to create a track or a number of tracks for recording. A project can contain as many or as few tracks as you want. You can add tracks using the **Track, Insert New Track** command or by pressing **Ctrl T**. Alternatively, you can simply double-click anywhere in the vacant area of the Track Control Panel.

It is advisable to name the tracks before you start recording. To do this, double-click in the track name area and type the name. The media file that is created when you record will then be given a sensible name that matches the track. Under **Options, Preferences**

you can display the **Recording** settings page and decide which items are automatically included in your track's file names. These can be any combination of track index (number), track name, and the time of the recording. We'll look at more of these recording preferences later in this chapter.

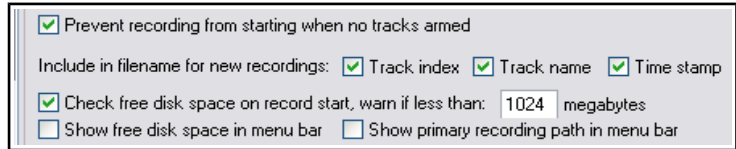

REAPER supports multitrack recording. The number of different sources that you can record at the same time is limited by the number of enabled inputs (under Preferences, Audio, Device) on your audio soundcard. Before commencing recording, for each track you will need to:

- Arm the track for recording.
- Assign the Input that is being used.
- Check that the sound level is right for recording.

Optionally, you may also:

- Select a recording format other than the default.
- Turn input monitoring on.

REAPER's **Preferences** include a page of **Track/Send** defaults which you can use to set track default characteristics (e.g. default volume fader level). These are explained in Chapter 22.

Note: You do not need to specify when creating a track whether it is to be a stereo or mono track. When assigning the track input for recording, you can use either a single mono input or a stereo pair. Note that both stereo and mono tracks can be panned between the left and right speakers as you wish. Panning is a topic that occurs throughout this guide, for example in Chapter 5.

3.5 To Prepare and Record One Track

1. Check the **Options** menu to make sure that **Record mode: Normal** is selected. We'll examine the other modes as this chapter progresses.
2. Click on the **Record Arm** button for that track (on the left) The button should now appear red.
3. Click the mouse over the **Input settings** for that track (below the pan fader - see right) to display a menu. The exact options on that menu will depend on which sound card and audio device(s) you have installed.
4. Select the required input from the menu. This will be the one to which the microphone or line that you are using for recording is connected. In most cases, this is likely to be one of the **Input: Mono** options. If you are not sure which option to pick, choose **Mono** when recording from a single microphone or lead.
5. Enable **Input Monitoring**. This is the first item (**Monitor Input**) on the **Record arm** button right-click context menu, or you can use the toggle **Record monitoring** button shown here (right). The location of this button may vary according to your choice of layout and the TCP column width. If your sound card supports direct monitoring you will most likely wish to use that, in which case you should not enable REAPER's input monitoring. Consult the sound card's documentation for more information about this. If your sound card does not support direct monitoring, then you should enable REAPER's input monitoring. There's more about input monitoring in sections 3.14 and 3.15.
6. Audition the sound while you adjust the volume on your audio desk or sound input device, so as to get a good strong signal without clipping. If in doubt, aim to peak at about -10dB . *Note that the recording level*

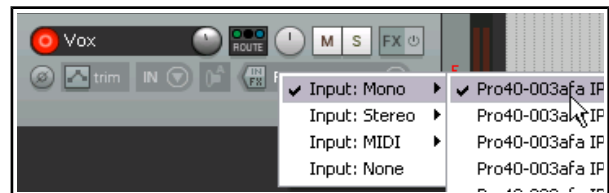

Up and Running: A REAPER User Guide v 5.24

cannot be controlled by adjusting the Track's volume fader: that controls only the playback level.

7. Press the **Record** button on the **Transport**, or use the keyboard shortcut **Ctrl R**.
8. To finish recording, either press **Stop** on the Transport, or press **Space**, or press the **Record** button again, or press **Ctrl R**. Now click on the **Record Arm** button for this track to "disarm" it.

Tip: The Input menu (shown above) includes an item **Input: None**. This can be used to prevent material from ever being accidentally recorded onto a track where it is not wanted, such as perhaps an FX bus or a folder.

Note 1:

If you use the **Record** button or **Ctrl R** to stop recording, recorded items are automatically saved.

If you press **Space** or **Stop**, the dialog box shown will let you save or delete any or all of your newly recorded media items.

Note 2:

REAPER supports "on the fly recording". This means you can also arm additional tracks after the recording has started. Those tracks will then also be recorded from the point at which you arm them.

Similarly, if recording more than one track, you can stop recording one while continuing to record the others by clicking on the **Record Arm/Disarm** button to disarm just that track.

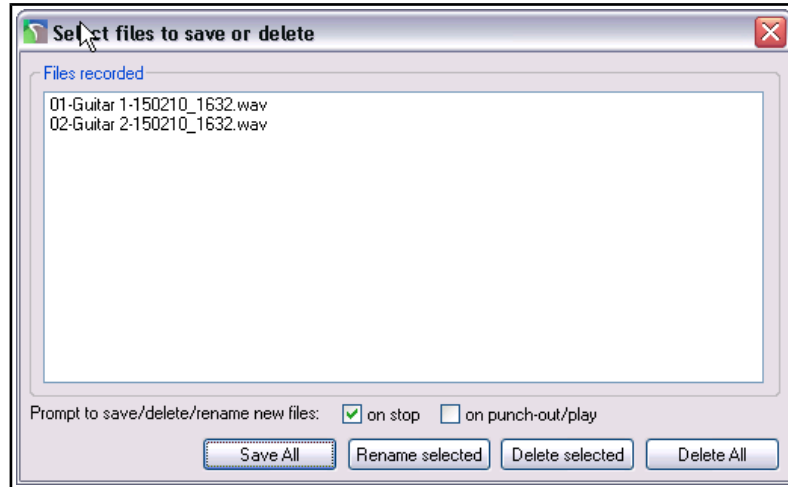

Tip: Track/Send Default Preferences. The Track/Send Defaults page of REAPER's preferences can be used to specify record configuration defaults for future tracks and projects, including turning input monitoring on and selecting default inputs – see Chapter 22.

Tip: When recording, make sure that the incoming signal is not too loud, or you can damage your recording equipment. Here's what to do:

1. Turn the input or gain control on your input device (e.g. firewire device or desk) all the way **down**.
2. If recording an instrument in-line, insert one end of the line into the instrument and the other end into your input device. Turn the output on the instrument fully **up**
3. Audition the instrument, slowly raising the input or gain control on your input device until it sounds right.

3.6 To Prepare and Record Multiple Tracks

To prepare multiple tracks for recording you could repeat all of the necessary steps as many times as you require tracks, but that might be tedious – and besides, it's too easy to make a mistake when selecting your audio inputs. You could end up with one input being recorded more than once, and perhaps another input being accidentally missed out. This is something that, at one time or another, is likely to happen with most DAW software. To avoid this problem, you can follow this sequence:

1. Use the **Insert, Multiple tracks** command to insert as many tracks as you require. The **Insert tracks** dialog will be displayed. Select the number of tracks required and choose whether they are to be inserted **After the last touched track** or **At end of project**. Click on **OK**. Name your new tracks.
2. Select all tracks to be recorded. After making your selection, click on the **Record Arm** button of any one of them to arm the entire selection.
3. One method is to use the **Routing Matrix**. Press **Alt R** to display this. In this example, four tracks are to be recorded at the same time. By default, all four tracks are at first assigned to the first input (above). If you were to record now, the same signal from the first input would be recorded four times! (Notice also that by default, input 1 is also assigned to track 5 - the FX bus - but as this is not armed nothing will be recorded there.)

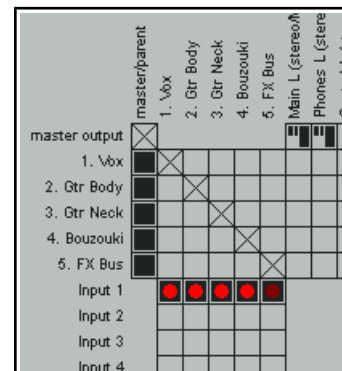

4. Click in the appropriate cells in the Routing Matrix to assign each track an input. The example shown uses audio inputs - Input 1 is to go to Track 1, Input 2 to Track 2 and so on. MIDI inputs may also be selected – these are listed below the audio inputs. You can also right click over any red cell to access the Record Input menu should you wish to do so.
5. Monitor the strength of the signals and record as before.

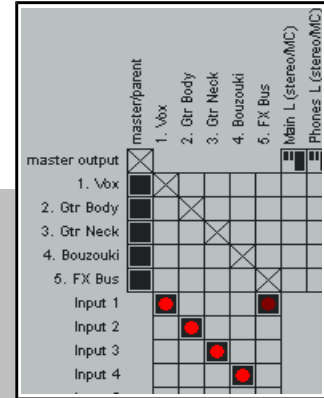

Tips: Using the Track Control Panel to prepare multiple tracks

Another option is to use the TCP to set up and record your tracks.

1. To define the same record settings for multiple tracks, select the required tracks, right-click on the arm record button, then make your choices from the menu. Holding **Shift** will over-ride this and apply your menu choices to the one track only. Inputs can be assigned to a selection of tracks in a similar way by clicking on the **Input** button.
2. To assign a series of mono inputs in sequence to a set of tracks, select the tracks then click the **Input** button of any track in the selection. Next, select **Assign inputs sequentially** then your required inputs – e.g. in the above example, this would be **Mono, Input 1 to Input 4**.
3. To insert a new track at the end of your project, you can simply double click in the Track Control Panel area, just below the last existing track.

3.7 Auto Arming Tracks

If you wish, you can ensure that tracks are automatically armed for recording when selected and unarmed when deselected. Simply select the track(s) then right click over the record arm button for any track in the selection and choose **Automatic record arm when track selected**. This command can be toggled on and off.

To set all tracks in a project to auto arm, choose the **Track** command from the main menu, then **Set all tracks to automatic record arm when selected**.

3.8 Using the Metronome

You can set up and use a Metronome when using REAPER for recording. To do this, you need first to right-click on the metronome button on toolbar, or the use the **Options, Metronome/pre-roll, Metronome/ pre-roll settings** command to set up your metronome. Left-clicking on the metronome button, or choosing the **Options, Metronome/pre-roll, Metronome enabled** command from the main menu, is then used to toggle the metronome on/off.

The Metronome Settings

Enable metronome: This turns the built-in metronome on or off.

The I/O Button: Immediately to the right of the *Enable Metronome* option, this allows metronome output to be directed to the device of your choice (e.g., Headphones). If any output monitoring FX are in use, the option to **Play metronome thru Monitor FX** will be available.

Run during playback: This will turn the metronome on during playback.

Count-in before playback : This will enable a count-in before playback.

Run during recording: This will turn the metronome on during recording.

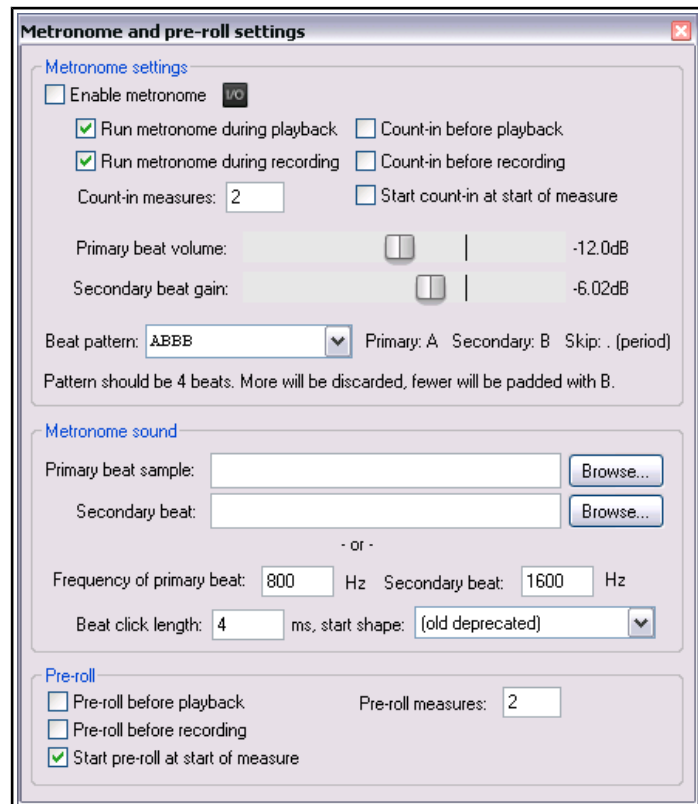

Up and Running: A REAPER User Guide v 5.24

Count-in before recording: This will enable a count-in before recording. Useful if you are recording yourself. It ensures that when you press **Ctrl R** the recording will not actually start until after the specified count-in. This gives you time to get back to the microphone and pick up your instrument.

Count-in length (Measures): This defines the number of measures a count in should be. If it is the very beginning of a project, it will wait those number of measures before starting to record. If you select a place to record within a project, it will start the count in this many measures before the time that you want to record at.

Primary beat volume: This determines how loud is the metronome volume.

Secondary beat gain:- The amount by which the volume of secondary beats will be adjusted.

Beat pattern: You can accept the default AABB or define your own.

You can also use Samples for your own metronome sounds.

First beat sample: This is the sample for the first beat – e.g., in 4/4 time, this sample will play on the 1.

Subsequent beat: This is the sample for other beats. For example, in 4/4 time, this sample will play on the 2, 3, and 4. To use your samples for the metronome in all your project you need to set up the samples, save a project with no tracks (but with any other project setting you think may be useful) then, in Preferences/Project specify that project as the default template to use for all new projects.

By default, REAPER uses a synthesised metronome. You can specify in Hz the **Frequency of first beat** and of **Subsequent beats**.

Beat click length xx ms: This is how long each beat click lasts.

Start shape: This can be hard (louder) or soft (quieter).

The **Pre roll** settings can be used so that when you start recording, or playback, the metronome will play for the specified number of measures before recording or playback actually begins.

Tip: The Metronome Time Base is controlled by the **Project Settings**. Press **Alt Enter** and display the **Project Settings** page if you need to change this.

3.9 Recording Stereo Tracks

You may wish to record from two inputs direct to a stereo track, for example, if you are uploading some previously recorded material from audio tape into REAPER, or are recording stereo paired microphones. Follow a similar procedure to that explained in section 3.5, selecting a stereo input instead of mono. The signal from paired stereo inputs can be recorded on to a single stereo item on a single track.

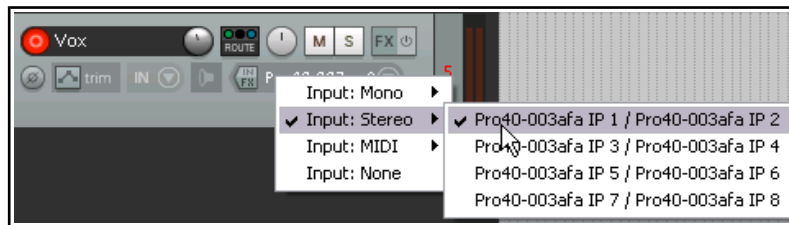

As has already explained in Chapter 2, it is advisable to open the Audio page of your Preferences settings and turn off the option to **Show Non-Standard Stereo Channel Pairs**. This will reduce your available stereo paired inputs to a more logical selection such as that shown above.

3.10 Multi-Channel Recording

This is a more advanced topic, less suitable for novices.

If you define a track as multichannel (for example, perhaps 4, 6 or 8 channels) then your recording input context menu for that track

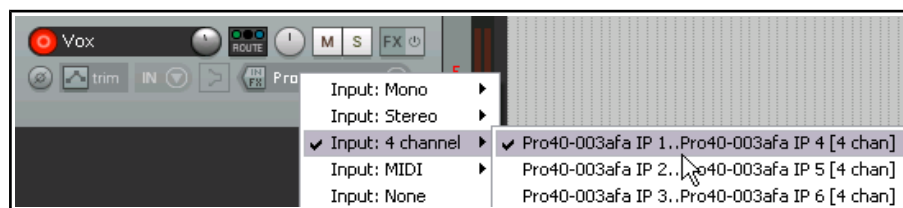

will include an option for multichannel recording. You can, for example, record from four, six or eight microphones simultaneously, each to a separate channel on the one track. This method is suited, for example, for use with four channel ambisonic microphone arrays as used in surround sound production.

For multichannel tracks, there is also a toggle command on the record arm context menu **Track VU meter, Show peaks from all track channels (not just 1+2)**.

3.11 Track Templates

After you have set up a track (or a number of tracks) for recording, you might think that you may wish to use this same track exactly as it is again in some future projects. This can be done using **Track Templates**.

To create a track template from an existing track (or selection of tracks):

1. Select the track or tracks.
2. Choose the **Track, Save tracks as track template** command.
3. When prompted, type a template name. If you wish, you can select the option to **Include track items in the template**. If so, any audio and MIDI items on the track will be included. You may also choose to **Include envelopes in template**. (Envelopes will be explained in Chapter 18).
4. Click on **Save**.

To import an existing track template into a project:

1. From the REAPER menu, choose the **Track, Insert track from template** command.
2. Depending on how your templates are stored, either select the required template from the menu, or choose **Open template**, then choose the required template and click on **Open**.

The **Insert track from template** sub-menu includes **Offset template items by edit cursor**. If enabled, any media items and/or envelopes saved with the original template will be inserted at the edit cursor position.

Note: Track properties and settings are saved into the template, including track name, inputs and outputs, any FX plug-ins (with any parameter settings, parameter modulation, and track controls), sends and receives. However, if a track included in a track template includes any sends to or receives from any track or tracks not included in the template, then these sends and receives will not be saved into the track template.

Tip: Organizing track templates. You can find where your track templates are stored by using the **Options, Show REAPER resource path ...** command (see Chapter 1). Here you can create subdirectories within the TrackTemplates folder where you to store and arrange your track templates as you please. Your subdirectories and their contents will automatically be shown on the **Insert track from template** sub menu.

3.12 Importing an Existing Project

The **Track, Insert Track from Template, Open Template** command can be used to import an entire REAPER project into your current project. All tracks in the original project file are imported – media items, track settings, FX, routing, etc. However, items that are not track specific (such as markers) are not imported.

To do this, simply select **Project Files** as the File Type when the **Open Track Template** dialog box is displayed, navigate to select the file you wish to import, then click on **Open**. The tracks from the imported project file are inserted immediately below the currently selected tracks.

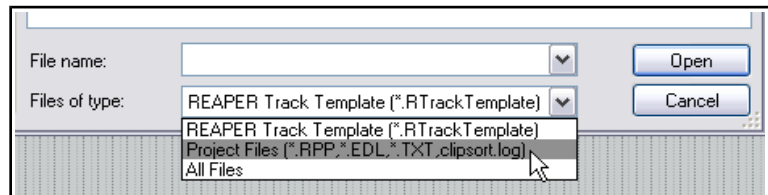

3.13 Project Templates

A Project Template goes further than a Track Template in that it can be used to create an entire Project File, based upon the structure and settings of the template file. For example, Project Settings (including Media Settings) are saved with a project template, along with the screen layout, which views are open, how they are sized, whether they are docked, and so on. However, unlike when creating a Track Template, you should remove the media clips and items from a file *before* saving it as a project template, otherwise every time the template is used to create a new file, those media items will be inserted. (Unless, of course, there are media clips that you actually *want* saved into the template).

To create a Project Template:

- With the source project file open, choose the **File, Project Templates, Save As Project Template** command. When prompted, give the template a name, then click on **Save**.

To create a new file based on a Project Template

- Choose the **File, Project Templates** command, then click on the name of the required project template.

To use an existing file as a template for all new projects:

- Choose the **Options, Preferences** command, then **Project**.
- Click on the **Browse** button labeled "When creating new projects, use the following file as a template".
- The contents of the project templates folder will be displayed.
- Select the required file, then click on **Open**.
- Click on **OK** to close the Preferences window.

Tip: If you are specifying a default project template it is a good idea to also save an empty project as a project template called **Empty Project**. Then, if you want to create a new file that doesn't use your default project template, you can do so by simply choosing from the menu **File, Project Templates, Empty Project**.

3.14 Layered Recording

The term *layering* refers to a recording technique in which two or more instruments and/or voices are recorded for the same song, but not all at once. The tracks can be recorded one at a time. An initial track is laid down – this is often a guide track which will be discarded at the end of the recording process. Then each other track is recorded while the musician or singer listens thru headphones to a mix of what has already been recorded and what she is recording now. In order to use this layered recording method:

1. With Record Mode set to **Normal**, record the initial track, as explained earlier.
2. After recording, make sure the output of this track is directed to the Master. *Make sure also that you "disarm" this track.*
3. Make sure that the Master is directed to whichever hardware outputs are connected to your headphones or headphone amp.
4. Add another track. Name it. Arm this track for recording. Select the Input used by the microphone or line that is to be used to record this new track.
5. Make sure that **Record: input(audio or MIDI)** is selected and that **Input Monitoring** is turned on for this track (see above). This will enable the person being recorded and the recording engineer to hear in their headphones a mix of previously recorded material with that being recorded now.
6. Adjust the Volume levels of the previously recorded track (using the track fader) and the volume level of the incoming signal (using your external mixer desk or audio device, or audio device control software) until you are happy with your headphone mix.
7. Press **Ctrl R** to start recording, and **Ctrl R** again to stop when finished. Again, disarm this track when you have finished recording on it.
8. Repeat this procedure for all other tracks to be layered. At step 6. you can feed into your Master a mix of all tracks previously recorded up to that point.

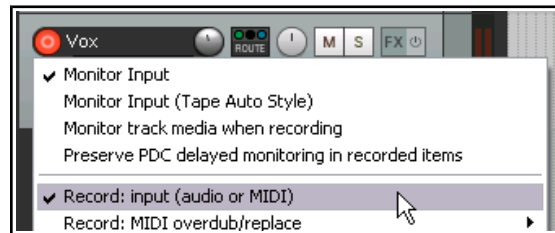

Note: If you notice an echo type delay in your headphones it will be because latency is too high. Lowering the block size (see 1.12) to 256 or 128 can improve this. On consumer quality built in sound cards, however, this might cause pops and clicks. For Windows users, the use of ASIO4ALL drivers might resolve this.

Tip: Many sound cards and USB or Firewire audio devices come with software that can be used for zero latency input monitoring and headphone mixing, especially those devices with multiple inputs and outputs. If you use that software for input monitoring, then you should turn off the input monitoring option within REAPER.

Try it now! Open the supplied project file **All Through The Night.RPP** and save it as **All Through The Night LAYERS.RPP**. Have a go at recording another instrumental track of your choice to go into this project - any instrument you choose!

Note 1: Monitor Input (Tape Auto Style). This option differs from normal input monitoring in that it monitors input only when the transport has stopped or when you are recording. During playback you will hear only the timeline audio, not the input.

Note 2: If you are monitoring an armed track when an existing track uses a plug-in (such as ReaFir) that has latency, you may wish to consider enabling the option **Preserve PDC delayed monitoring in recorded items**. This more advanced topic will be explained in more detail later in this chapter.

3.15 Overdubbing and Punch Recording

You can go over an existing track to re-record a section with which you are not satisfied, to correct perhaps just a few notes of an instrument, or a line or two of a vocal. Use punch recording for this. You can play back in your headphones previously recorded material along with any other tracks while you record. At the point where you want recording to begin, the track on which you are recording will cut out, and the recording will begin. At another point specified by you, the recording will stop, and the existing recording will come back in.

The technique can be applied with both audio and MIDI items. MIDI is discussed later in this chapter when **looped time selection recording** is also explained.

3.16 Non-Destructive Punch Recording

By default, punch recording is not destructive: it creates a new take, but does not destroy the original. To use punch recording, follow this sequence:

1. Choose the **Options** command, then **Record mode: time selection auto punch**. The display of the Transport Bar record button will change. Disable the Toggle Repeat function on this toolbar.
2. Select the track and arm it for recording. View the **Options** menu and for now ensure that **Show all takes in lanes (when room)** is *not* selected. We'll look at lanes shortly. Also, for this example, make sure that **Loop points linked to time selection** is **not** enabled.
3. Make sure that the track output is sent to the Master and that Input Monitoring is enabled.
4. Make sure that the Master output is directed to the audio hardware outputs to which your headphones or headphone amp is connected.
5. Click once on the existing media item to select it. Click and drag along the arrange background area to select the region that you want to be re-recorded (see above).
6. Rewind the track to a point a short way before the position where you wish to start recording. This can be done by simply clicking at the required place on the timeline.
7. Press **Ctrl R**. You will hear the recorded material up to the start of the defined region, where you can re-record that passage. Press **Space** to stop when you have finished recording. Accept the option to save your recorded media. Restore normal recording mode when you have finished punch recording.

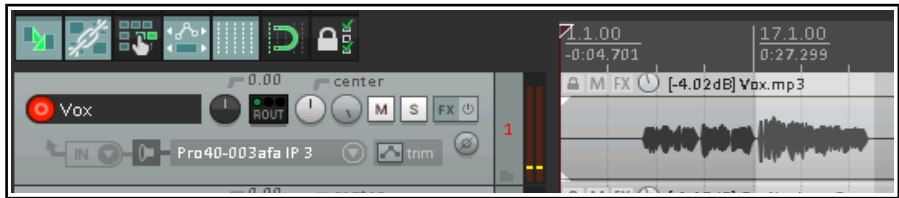

Your track now contains two media items. What's happened to the originally recorded passage? Well, it's still there and you can still use it if you like. Pressing **Ctrl L** toggles the display of all takes or active take only (see above). We'll learn more about this soon.



Note: You can enable the option **Monitor track media when recording**. If you do this when punching in, say, a guitar or vocals, regular **Monitor Input** will cause you to hear both the existing and the new material right up to the punch, then only the new material during the punch. **Monitor Input (tape auto style)** will monitor only the existing materials up to the punch, then only the new material.

Tip: If you make a mistake or change your mind when overdubbing, you can use **Ctrl Z** to undo the recording or you can select the unwanted media item and use the **Delete** key to remove it.

Getting to grips with REAPER's various record modes and in particular how they work in combination with other options (such as monitoring) can be somewhat bewildering for new users. Chapter 25 includes a summary table **Troubleshooting Record Modes and Monitoring**.

3.17 Destructive Punch Recording

You have the option when punch recording of actually removing from the existing track the previously recorded material if you wish. If this is what you want, use the **Options, New recording that overlaps existing media items** command to turn on the toggle option **Trims existing items behind new recording**. Be careful how you use this. You can restore this option to its default setting by choosing **Splits existing items and creates new takes** from the same menu.

3.18 Fades and Crossfades

REAPER allows you to apply automatic crossfades and fades in and out of your recorded items. This feature can be turned on and off or customized thru the **Options, Preferences, Project, Media Item Defaults**. You

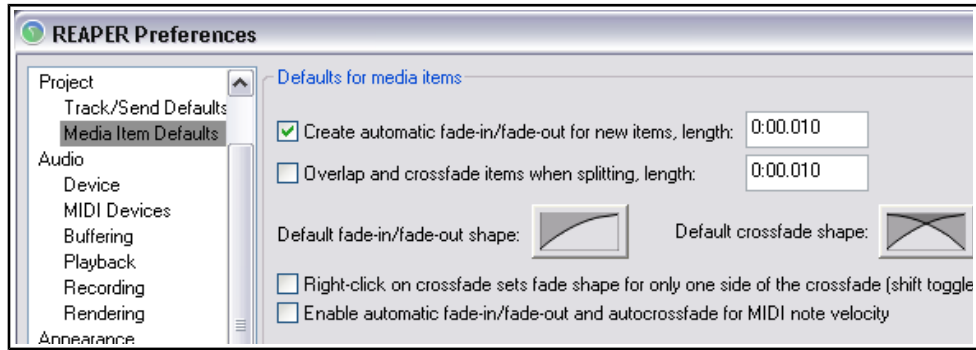

can select a preferred shape and duration (length) for your fade curves. Clicking on the image of the curve (shown above) causes you to be offered a number of choices (see right). As you will see in Chapter 7, you can easily change the default fade type and/or length for individual media items. If you prefer not to use automatic fades, just disable that option.

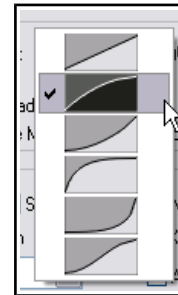

3.19 Recording Multiple Takes

REAPER's multiple takes feature can help you when you want to record several versions of a track to see which you prefer. It works like this:

1. Set record mode to normal (**Options, Record Mode: Normal**).
2. Make sure that **Enable track free item positioning (FIPM)** is *not* enabled (i.e., not ticked) for the tracks being recorded. Use the TCP right click context menu to do this. We'll get to FIPM later in this chapter.
3. Record your first take of the track.
4. Rewind to the start then record your next take.
5. Repeat step 4. as many times as you wish.

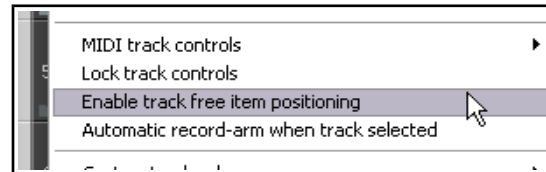

In the example shown, an initial vocal track has been recorded, then above it three takes have been made of a vocal harmony track.



Notice the text displayed with the name of the media item displayed for the Harmony Vox track. It begins with the text **Take 3/3**.

Note: Under **Options, Preferences, Appearance, Peaks/Waveforms** there is a setting to **Automatically color any recording pass that adds new takes to existing items**. When you are recording multiple takes to two or more tracks at the same time, enabling this option can help you to visually identify which takes belong in the same set.

3.20 Showing Takes in Lanes

Optionally, when you have multiple takes, you may choose to have them displayed in lanes. This of course takes up more room on the screen, but has the advantage that it makes it easier to see for your various tracks which take is currently selected. This option is toggled on and off by pressing **Ctrl L** or by choosing **Options, Show all takes in lanes (when room)** from the Main Menu.

In the first example (shown right), three takes have been made of a vocal duet. The first and second are complete takes, the third is a punched-in overdub of only the middle section.



In this case, the option to **Display empty take lanes (Options, Take lane behavior menu)** has been enabled. This ensures that the short overdubbed section is given its own complete lane. This makes it easier for you to keep track visually of which parts of each take belong together.

For both tracks, the second take is currently selected (except for the overdubbed section) and will be played.



In this second example (right), different takes (and permutations of takes) have been selected for the different tracks.

In this third illustration, the track height has been reduced, so that at any point



only the selected take is visible. However, as long as the option to Show All Takes in Lanes remains active, the lanes will automatically be restored to view when the height of these tracks is expanded.

Note: When you create multiple alternative takes in this way you will later be able to easily pick the best passages from each of your takes and join them together as a single item. The method for doing this will be explained in Chapter 8 of this User Guide.

3.21 Using Color Coded Takes

REAPER's **Item, Item and take colors** command offers a variety of interesting ways that you can use color when working with takes and items (see right). We'll look at this whole topic in detail in Chapter 7, but for now notice the command **Set active takes to one random color**.

If after making your preferred working selection from the available takes for any track you double-click on that track in the Track Control Panel then all media items in that track will be selected.

Choosing **Set active take to one random color** will now produce an effect similar to that shown below. This will only be visible if an option to show take color is enabled in the Appearance, Peaks/Waveforms page of your Preferences.

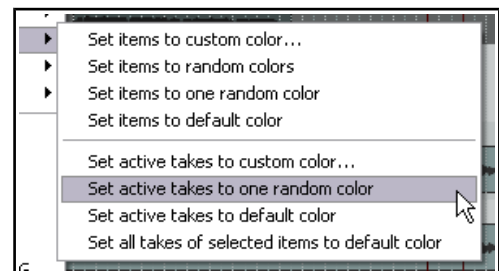

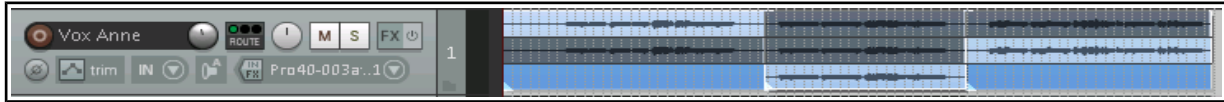

3.22 Working With Multiple Takes

Where an item includes more than one take, you can right click over any take and use the **Take** command to control and manage your multiple takes. The Take submenu is quite extensive - we'll explore most of its features in Chapter 8. For the time being, however, you should be aware of the following, especially if your takes are not displayed in lanes.

Command	Shortcut	Effect
Next Take	T	Displays next take for selected track(s).
Previous Take	Shift T	Displays previous take for selected track(s).
Explode All Takes to New Tracks		Creates a separate track for each take (see below).

Explode All Takes to New Tracks

differs from **Show All Takes in Lanes** in that it lets you treat each take separately as a separate track. The picture on the right illustrates this. Track 1 consists of two takes which are shown in lanes. After exploding these takes to new tracks we have (in addition to the original track) two new additional tracks, one for each take.



Caution: One look at the **Take** submenu (on the media item's right-click context menu) will show you that there are commands available for deleting takes and cropping to active take. You are advised to avoid these until you have worked thru Chapter 8 of this guide. In particular, avoid using the **Delete** key when selecting takes: you are likely to delete more than just the take that you don't want!

Try it now! Open the project file **All Through The Night LAYERS.RPP** (which you saved earlier) and add a vocal harmony track to this project. Use this track to record three takes – then save the file.

3.23 Overlapping Items

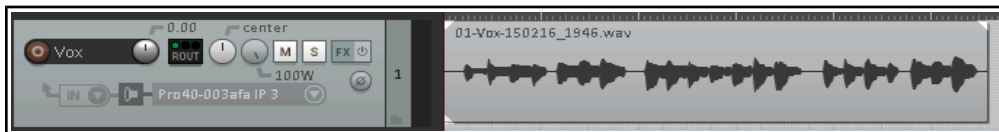

You have already been shown two of the three overdubbing options on the

Options menu command **New recording that overlaps with existing media**, i.e. **Splits existing items and create new takes (default)** and **Trims existing items behind new recordings (tape mode)**. The third option is to **Create new media items in separate lanes (layers)**.

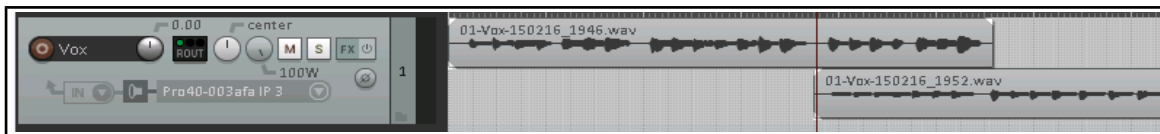

This example shows this. In the first illustration (top) a part of a track has been recorded. In the second illustration (above), we have returned to this track and with the option **Create new media items in separate lanes (layers)** enabled we have re-recorded the last part again, together with some new material.

In this case, the second take is to all intents and purposes a separate media item. You can choose which of

these media items are and are not played.

There is also an **Options** menu command to **Show overlapping media items in lanes**. The maximum number of lanes can be set on the Options, Preferences, Appearance page.

This general topic will be addressed again later in this guide, especially in Chapters 4, 5 and 7.

3.24 Recording Multiple Additional Items

We have already seen how you can use REAPER to record multiple takes on the same tracks. Later, in Chapter 8, you will be shown how to edit these, so as to take the best parts from each of several takes and then patch them together into a single take.

As an alternative to using multiple takes, however, you may wish to record additional items onto an existing track, perhaps overlapping. This is an example of where free item positioning can offer you greater flexibility. By default, free item positioning is not enabled. To record extra items (rather than additional takes) on to an existing track, follow this sequence:

1. Set record mode to normal (**Options, Record Mode: Normal**).
2. Make sure **Free Item Positioning** (FIPM) is enabled (ticked) for the tracks being recorded. Right click on the Track Control Panel for the selected tracks and select **Enable free item positioning** if this is not already ticked.
3. Record your first item for the track.-
4. Position the cursor at the point where you wish to record the second item. Record this item.
5. Repeat step 4. as often as required.

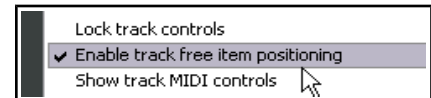

Example

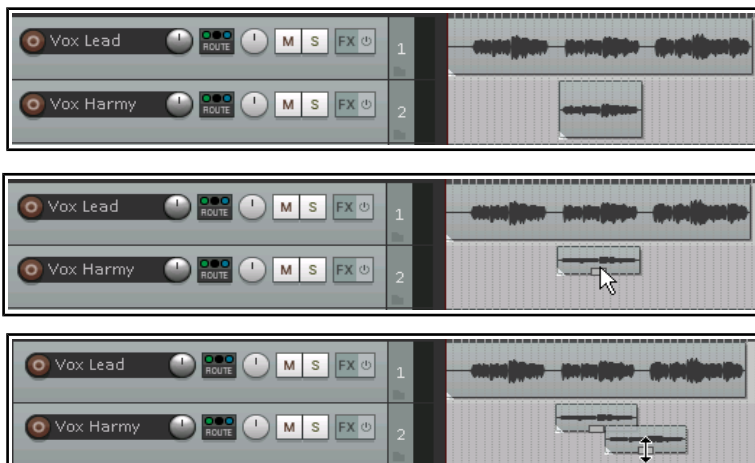

In the first screen shot shown here, Track 1 contains a Vocal Track and Track 2 a Vocal Harmony for part of the song.

In the second screen shot, the option for **Free item positioning** (FIPM) has been enabled for Track 2. The mouse cursor shows a small handle that can be used to adjust the height of this media item.

In the third screen shot, a second Vocal Harmony has been recorded on to Track 2, overlapping the original harmony.

Notice that this is not an alternative take of the first harmony, but an *additional* media item.

Note: In the Options, Preferences, Project, Track/Sends Defaults window there is an option to make free item positioning enabled for your tracks by default.

3.25 Recording with Empty Events

Empty Events are a clever device which can be helpful when you are overdubbing or layering. If you know exactly the regions where you want recording to start and stop, you can define these regions by inserting empty events. Then, when recording is commenced, only those regions defined by the empty events will actually be recorded.

Let's take an example where a vocal track has already been recorded, and we want to lay down a harmony vocal, where this harmony is only used for the chorus line of the song. This is how you would do this:

Up and Running: A REAPER User Guide v 5.24

1. Insert a new track to be used for the vocal harmony. Ideally, you should name this track straight away.
2. Arm the track for recording. Assign an audio input in the usual way. Turn on **Monitor Input** for this track, and make sure the output from the Master is directed to your headphones.
3. Use the **Options** menu to ensure that **Record mode: auto punch selected items** is chosen. Notice the appearance of the Record button in the transport bar changes.
4. To create an empty item, first make sure that your new track is selected. Click and drag to define a time selection, then use the **Insert, Empty item** command to create the empty item. Repeat this as often as required. If necessary, click and drag to adjust their exact positions. An example is shown here.
5. If you need to resize any of them, hover the mouse over the border between the end of the event and the background, about half way up. Click hold and drag to the left to make it shorter, or to the right to make it longer, then release the mouse.
6. Select all of the required events. To do this, use the **Ctrl** key while clicking on each in turn. If you need to reposition the play cursor before recording, do so by clicking on the Timeline. Arm the track for recording.
7. Press **Ctrl R** to start recording. When finished, press **Ctrl R** again to stop. If prompted, accept the option to save all files. Your previously empty media items will have been replaced with your newly recorded material. Disarm the track.

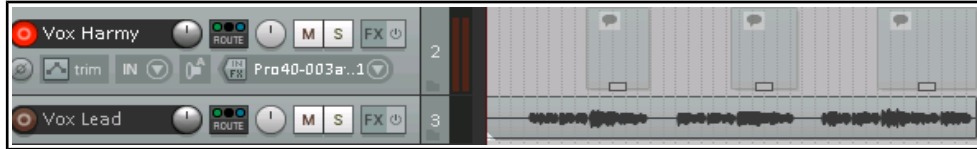

3.26 Recording with Input FX Plug-ins

Audio effects (FX) are usually added to a track later in the production process, well after the material has been recorded. This subject was introduced in Chapter 2, and you'll find more about it elsewhere (for example, in Chapter 16). However, REAPER does allow you to add effects to material as it is being recorded if you wish. Use this facility with caution, as once an effect has been added to a recorded item in this way it cannot be easily removed (if at all). The procedure for recording with FX is as follows:

1. Arm the track for recording and select the required audio or MIDI input device in the usual way.
2. Right-click on the Record Arm button and choose **Track input FX chain** from the context menu. This causes the **Add FX to Track** window to be displayed.
3. Select any effect required, then click on **OK**. Set the parameters for this effect.
4. Use the **Add** button to add any additional effects.
5. Close the FX window.
6. Audition the performance and the effects as necessary (see comment below), then record the track in the usual way.

Effects placed in a track's input FX chain only use resources when the track is armed, and are applied destructively to the media item during recording. Most probably, before doing this you will want to audition the instrument or voice being recorded together with these FX so that you can get the parameter settings right. To do this, you simply need to keep the track armed and turn on input monitoring while you listen to the live material and adjust the FX parameters to suit. Input monitoring is explained elsewhere in this guide, for example in the sections dealing with layered and overdub recording.

3.27 Preserve PDC Delayed Monitoring in Recorded Items

If you are monitoring audio on an armed track against previously recorded tracks any of which uses a plug-in that has latency (such as, ReaFir) this will cause the output to be delayed. In this case you may wish to have the recorded output sound exactly as you are hearing it while recording. For example, you might be playing the notes early in order to make it sound right.

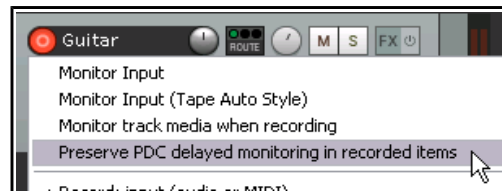

With this option on, it will play back the same way you heard it as you played it, with the option off it will be earlier (as the PDC of the plug-in will take effect).

3.28 Recording a Track's Output

There could be any number of reasons why you might wish to record a track's output. One example might be to record the output from an external synthesizer directly onto an audio track, as a wave file or similar. Here is an example of how you might do this:

1. Make sure that your MIDI keyboard is connected to your PC.
2. Create a new track. Name it and arm it for recording. Enable input monitoring.
3. Select **Record: output** then your required option. Most likely this will be mono, latency compensated.
4. Select **Input: MIDI**, then select your input device from the available options.
5. Make such adjustments as you need (e.g. to the synth parameters) while you audition the music.
6. When ready, record.
7. Stop recording when finished.

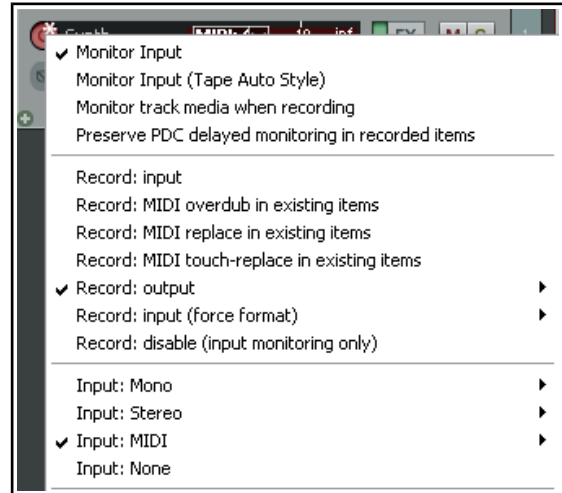

3.29 Recording FX Bus Output

You can record the output of an FX bus track. Doing this opens up creative mixing options. For example, you could record the output of a reverb bus to a stereo audio track, then use stereo or dual panning to adjust the positioning of that effect in your mix. Here's how:

1. Set up a **FX Bus** track, select it, and arm it for recording.
2. You might wish to also turn up the track's **Receives** to get a good strong signal – you can always turn down the volume when playing it back later.
3. Set the track to **Monitor Input** and chose a **Recording Mode**. This is likely to be **Output, Stereo**.
4. Play the song and monitor the signal level.
5. Rewind to start and press Record.
6. Stop recording when finished.

Tip: After doing this you will most likely want to mute the sends to the bus and set the bus FX to bypass. It can still be a good idea to leave the FX inserted in the bus, as a record of how the output was produced.

3.30 Recording MIDI

You have a number of options for recording MIDI, depending on what equipment you have and how it is set up. In every case, however, the principle is the same:

- You will need to use either REAPER's virtual keyboard or a MIDI input device, such as a keyboard attached via a MIDI In port on your sound card or other audio device.
- You will need to create a track (or assign an existing one) for your MIDI recording.
- You will need to assign an output device for your track.
- You will need to assign a Channel for the MIDI item.
- You will need to turn Input Monitoring on to be able to hear what you are playing.

REAPER's **Virtual MIDI Keyboard**, can be played using your mouse or PC keyboard. This keyboard is displayed using the command **View, Virtual MIDI Keyboard**. The shortcut keys **Alt B** can be used to toggle display on and off.

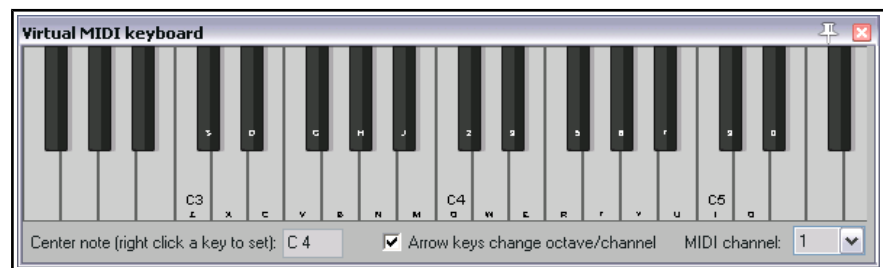

Procedure for Recording to a new MIDI Track

1. Insert a new track into a project file. Arm this track for recording.
2. Make sure that your MIDI keyboard is connected to the computer, MIDI Input of your sound card or Audio Device and that it is switched on. In this example, we will be using the **REAPER Virtual MIDI Keyboard**. If this is not visible, press **Alt B**. Right click over any key that you wish to be your centre note.
3. On the track you are using, right click over the arm record button (as shown). Make sure that **Monitor Input** and **Record Input** are both selected, and that you have selected the **Virtual MIDI Keyboard** as the **Input: MIDI** device. For this example, select **All Channels**.
These settings can be made in the Routing Matrix if you prefer.
4. Make sure the Track's output goes to the Master, and that the Master output goes to the hardware audio outputs to which your speakers or headphones are attached.
5. In this example we will use a Software Synthesizer. Open the **FX** Window for this track. You will need to insert a Software Synthesizer here. You can use any such VSTi or DXi synth that you already have installed. In this example, we will be using **VSTi ReaSynth (Cockos)**, which is included with REAPER. For the time being, leave the ReaSynth parameters at their default settings.
6. Press **Ctrl R** to start recording. Play a simple tune on the Virtual Keyboard. Use your mouse or PC Keyboard – e.g., **zxcvbcxz** will play half a scale up and down. When finished. Press **Ctrl R** again to stop recording. If prompted, save your media item.

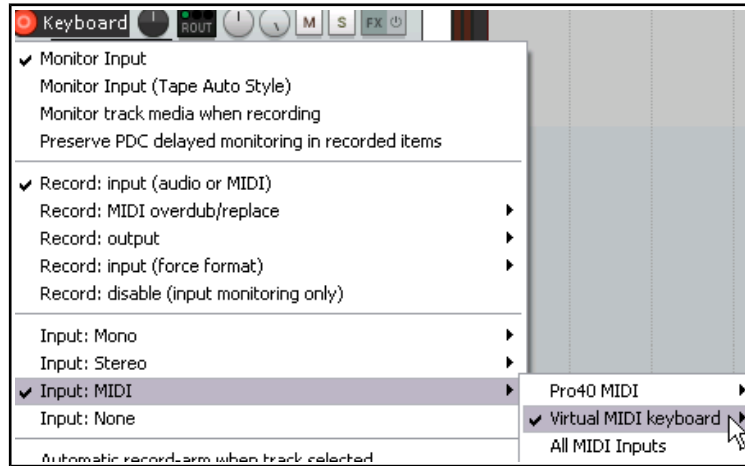

See also **Recording MIDI from keyboard checklist** later in this chapter.

In Chapter 13 we will see how your MIDI data can be edited using REAPER's built in midi editor.

Procedure for Playing Back a MIDI Item

Play the track. As it plays, you can alter the nature and shape of the sound by adjusting the soft synth parameters. When you have found a sound you like, you can click on the + button in the FX Window (indicated by the mouse cursor, shown left) and then choose **Save Preset** to name and save that set of parameters. Your named preset can be recalled

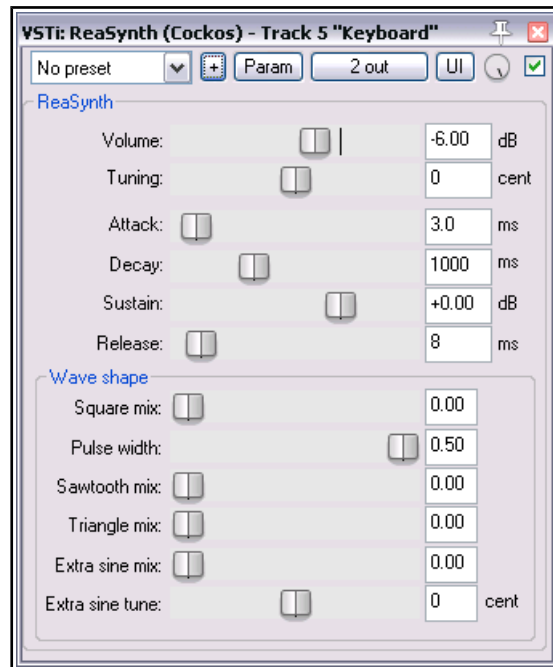
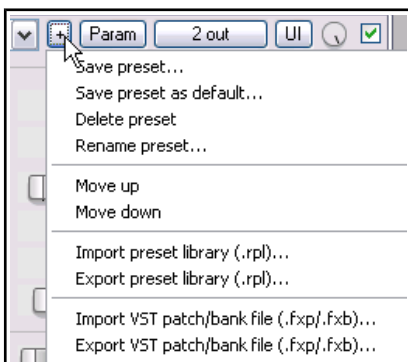

from the Preset drop down list any time. You can make and use presets in this way for all FX Plug-ins and Synths. With VSTi synths, you are also able to import and export patch/bank files (see above).

Note: The example above demonstrates an important difference between MIDI and Audio. With **Audio** the actual sounds made by the instrument or voice are recorded. It is possible to use FX like EQ and Compression to alter how the audio item sounds when played back, but the audio item itself stays the same.

With **MIDI**, you are essentially recording a series of instructions that by themselves have no sound. The music is created when those instructions are fed to a synthesizer. By changing the parameters of the synthesizer's settings – or even by changing the synthesizer – we are able to produce a completely different sound.

Despite these differences, both audio and MIDI items can be included on the same track.

Note: Before recording, you can assign sequential input channels to a number of MIDI tracks in one action. Select the tracks, then click on the **Input** button for any one of them. From the menu, choose first **Assign inputs sequentially**, then **MIDI (sequential inputs or channels)**, then select the MIDI device, then the channel selection (e.g. for four tracks, perhaps channels 1 to 4).

3.31 Other MIDI Recording Modes

When recording MIDI, you should select one of six modes. In the above example, we used **Record Input**. With this mode, any existing events will be retained: the new material will be recorded as a new take. Four of the other five are **Record: MIDI overdub replace** modes:

- **Record MIDI overdub:** this will add new notes on any channel **within** existing items while preserving what is already there.
- **Record MIDI replace:** from the time you start recording until you stop, existing MIDI notes will be removed and any new material played on any channel will be recorded in their place.
- **Record MIDI touch-replace:** existing MIDI notes will be replaced by any new notes played over them on the same channel as the original material. All other existing material will remain as it is.
- **Record MIDI latch-replace:** existing MIDI material remains unchanged until you strike the first note. All of the old material will then be replaced with notes played on the same channel as the original material until recording is stopped.
- **Record Output -> Record: output (MIDI):** Similar to the input mode, but records the MIDI signal coming out of the FX chain.

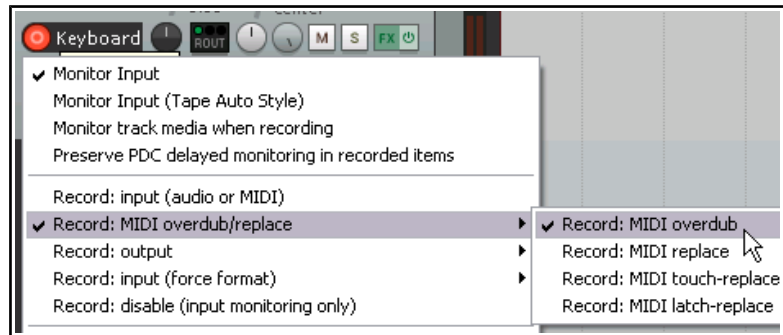

Note that these options can often be used effectively with time selection recording (see sections 3.16 to 3.18) and looped time selection recording (see below).

Try it now! If you have a MIDI keyboard, open the project file **All Through The Night LAYERS.RPP** (which you saved earlier) and add a MIDI keyboard track to this project.

3.32 Recording With a Virtual Instrument

To use a virtual instrument (such as a VSTi or DXi plug-in) for recording a MIDI track, you should choose the **Insert virtual instrument on new track...** command. This can be done either by choosing **Insert** from the main menu (then **Virtual instrument on new track**), or by right clicking over the vacant Track Control Panel area and selecting this command from the context menu.

You will then be presented with a selection of all the virtual instruments that you have installed on your system. Double-click on the required item. The track will be created, armed and named and the instrument displayed.

The example shown here is for **ReaSynDr**, which requires four outputs. If the item selected (like this one) requires multiple outputs then REAPER will create the initial track and prompt to ask you if you would like the other required tracks to be automatically built. If you select **Yes** the entire output chain will be built for you. What exactly this produces will, of course, depend upon which Virtual Instrument you have selected.

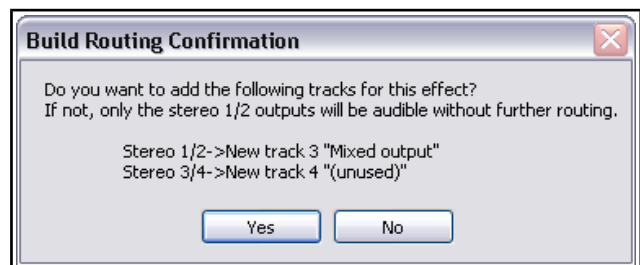
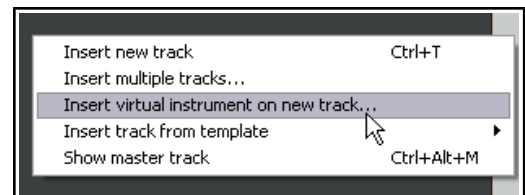

Monitoring an External Synthesizer

If you are working with an external hardware synthesizer then it is likely that at times you may wish to monitor its output in REAPER. This topic is covered in Chapter 13, Manipulating and Editing MIDI Items.

3.33 Using Microsoft GS Wavetable SW Synth

You can use the Microsoft GS Wavetable Synth if it is included with your version of Windows. This can be especially useful for playing any MIDI files that you may wish to import into REAPER. You will be shown how to import files in Chapter 4.

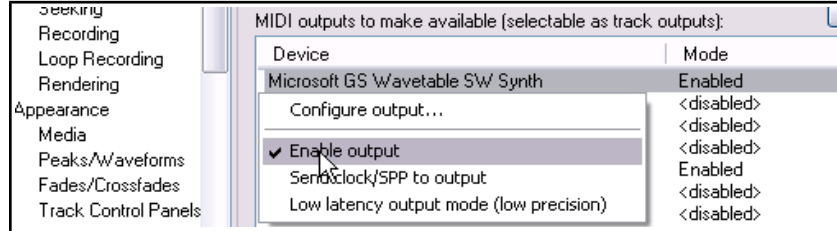

To enable the Microsoft GS Wavetable SW Synth:

1. Go to **Options, Preferences** and display the **MIDI Devices** screen.
2. Under MIDI Outputs, right click on Microsoft GS Wavetable SW Synth and select **Enable output**.
3. Click on **Apply**, then on **OK**.

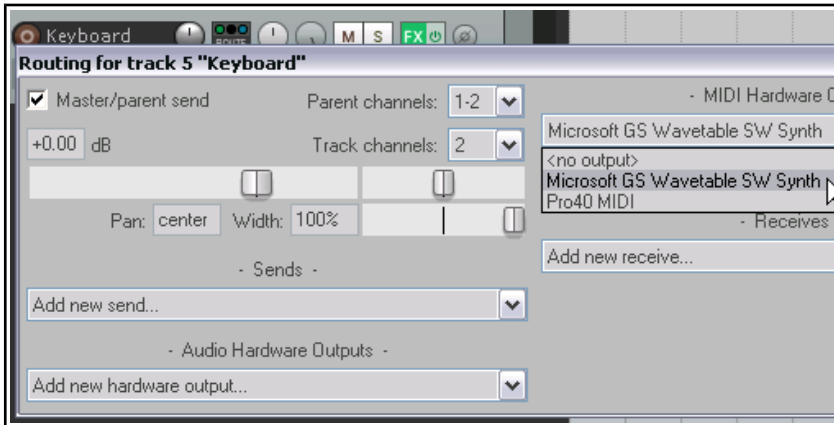

This Synth will now be available as a MIDI Hardware Output. You can if you wish now use the **Microsoft GS Wavetable SW Synth** as your output device instead of using a software synth (see above right).

3.34 Looped Overdubbing and Looped Time Selection Recording

Loop overdubbing allows you to make repeated overdubs of a section of recorded material without having to be repeatedly stopping and starting. The technique can be used with both audio and MIDI. In both cases, you will need to check your **Options, Preferences, Audio, Loop Recording** settings. Set **When recording and looped add recorded media to project to On stop**. Usually you will also want to enable **In loop recording, discard incomplete first or last takes if at least one full loop was recorded**. You should also (from REAPER's main **Options** menu) disable **Loop points linked to time selection** and enable **Record mode: Time selection auto-punch**.

Now arm your track for recording, select your record options and make your time selection just as you would for normal punch recording. Click and drag along the timeline to create the loop – this should enclose the time selection, as shown below. Make sure **Toggle repeat** (next to Record button) is enabled on the Transport Bar.

When **Record input (audio or MIDI)** is selected,

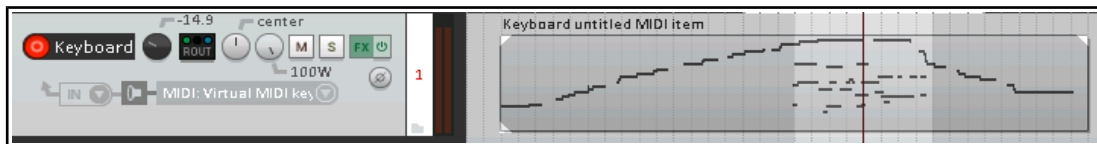

then both audio and MIDI essentially behave in a similar way. When you record, new material will be recorded within the time selection (and added to the MIDI item) for each pass over the loop until you press **Stop**. The loop is used to audition material immediately before and after the section being recorded.

For example, you might choose **Monitor input** and **Record Input (audio or MIDI)** and **Input MIDI** then your MIDI device. If so, the outcome will be similar to that shown here.

Audio material recorded with **Input MONO** rather than **Input MIDI** would produce a similar result, except of course the media items would be audio instead of MIDI. You will, however, get significantly different outcomes if you use any of the **Record: MIDI overdub/replace** options with looped time selection recording. In each case, new takes will not be created. Instead, the existing take will be edited. For example:

Record: MIDI Overdub: with each loop, the new material will be added to the existing material within the time selection.

Record: MIDI Replace: with each loop, all previous material within the time selection will be replaced with new material. For example, the first loop will replace existing events within the time selection. Second time around it will replace the material recorded in the first loop with new events, and so on. Only the most recent material will be saved.

Record: MIDI Touch-replace: Each time you play a note within the time selection any existing material concurrent with that note will be replaced with new material is on the same channel. For example, if you play correctly except for one wrong note first time, you can correct just that one note second time round.

Record: MIDI Latch-replace: Each time round the loop all existing material in the time selection will be replaced with new material if on the same channel only from the moment you press your first note. This technique can be useful, for example, if you are replacing existing material little by little.

3.35 Recording with External Hardware FX

REAPER can record a track with an external hardware FX device in much the same way as you might use an external device as an insert when recording on an analog desk. You use a plug-in called **ReaInsert**. If you want to try it out step by step, create a new REAPER project file, insert a track, then get your FX device ready.

Example

1. Connect an otherwise unused audio output to the input for your FX device. Connect the output of your FX device to an otherwise unused audio input.
2. Create a new REAPER project file and add a single audio track. Give this track a suitable name. Let's record a vocal with the FX on it.
3. Connect your microphone to an otherwise unused audio input. Switch on the FX Device.
4. Arm the track for recording.
5. Select the input device (to which the line or microphone is attached), select **Monitor Input** and specify that you want to **Record Output** and choose your required option (such as **Mono, Latency Compensated**), just as we did in the section **Recording a Track's Output**.
6. Now display the FX Window for this track, and add the **FX VST:ReaInsert** to this window (see right).
7. Specify the actual Hardware Sends and Returns that you set up at steps 1. and 3.
8. Make sure the FX Device mix is set to 100% Dry, and within ReaInsert enable the option **Automatic device latency adjustment**. This enables REAPER to calculate the required degree of delay compensation.
9. With the track's output directed to your headphones, monitor the required Volume and FX Levels, including the FX Wet/Dry mix.
10. When you are ready, Record.

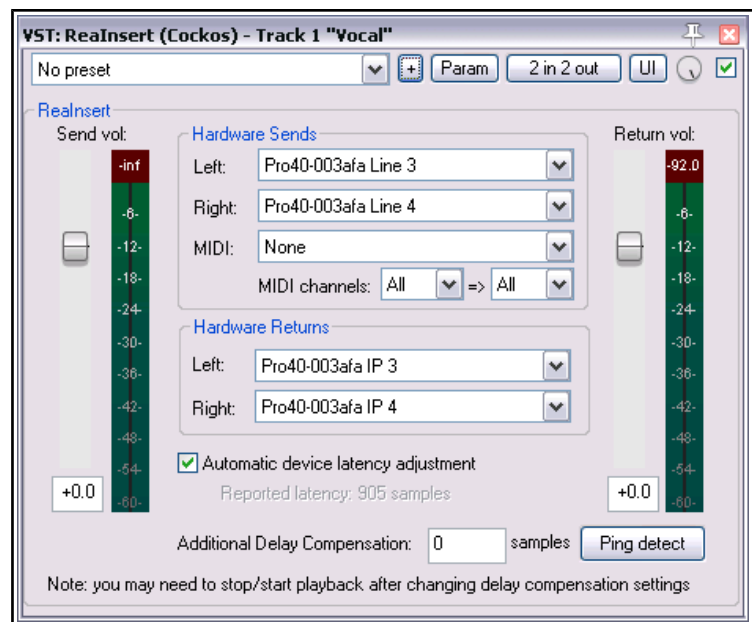

- When finished, don't forget to disarm the track and set the ReaInsert plug-in status to **Bypass**.

3.36 Preference Settings for Recording

The **Recording** page of the **Preferences** window can be used to specify a number of options about REAPER's recording behavior. Available options include:

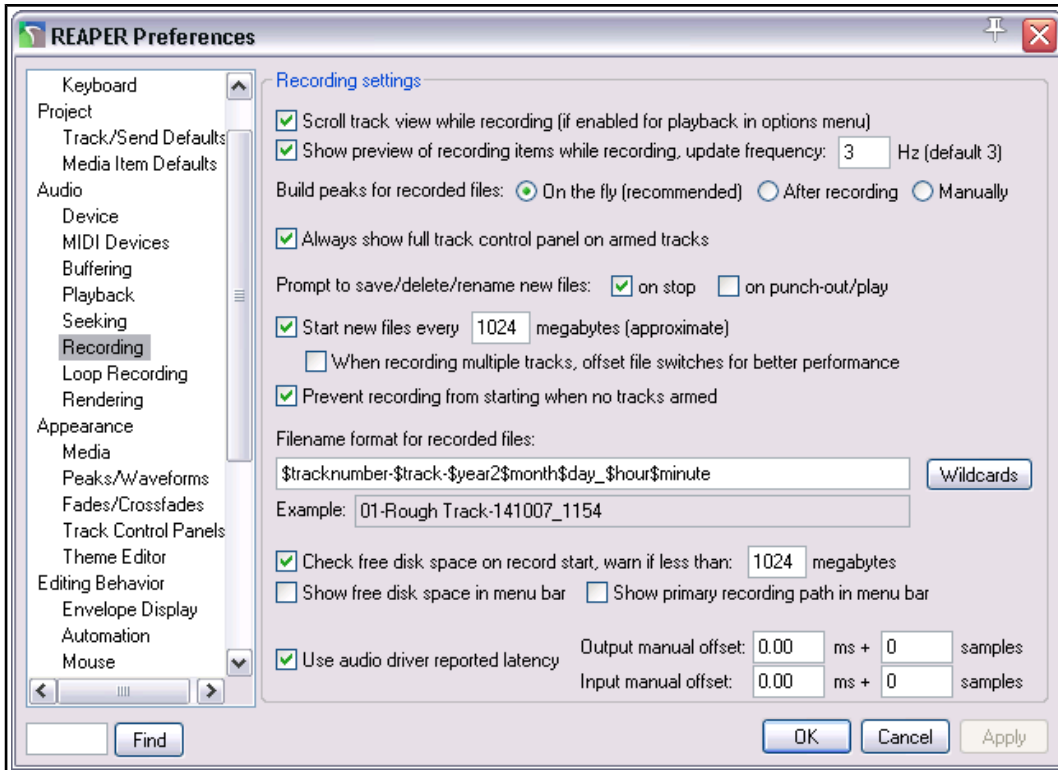

- To scroll track view while recording.
- To display a preview of media item peaks as they are being recorded. This is useful to confirm that you really are recording and haven't, for example, forgotten to arm one or more tracks. You can also specify a screen update frequency.
- When to build the peaks for recorded media files.
- To automatically display the whole Track Control Panel (including VU meters) when a track is armed.
- Whether to prompt to save/delete/rename files when recording is stopped. If you disable this option, files are automatically saved.
- Whether to prompt to save/delete/rename files on punch out. If you disable this option, files recorded by this method are automatically saved.
- Whether to start recording to a new file after a specified number of megabytes. This can help to make data secure when recording a long live performance,.
- Prevent recording from starting if no track is armed. You may wish to turn this off if you are using layered recording for a track (or tracks) where recording is not required to start until some way into the song.
- Which items to include in the file names for recorded media – you can include any combination of the track index number, the track name and the time stamp (or none of these).
- To check for free disk space before recording, and to display the amount of free disk space and/or recording path on the menu bar.

3.37 Track Preferences for Recording

The REAPER **Track Defaults** settings includes a number of items that you can use to help make the recording process a little easier. These settings can be found on the **Project, Track/Send Defaults** page of the **Options, Preferences** window. Settings on this page include:

- The default gain level for the track's volume fader.
- Whether output should be routed to the Main send.
- The default new track height.
- Whether new tracks are automatically armed for recording.
- A Record Config option to set defaults for the Record Arm context menu. Options include, to turn on by default Input Monitoring and specify default record input settings.

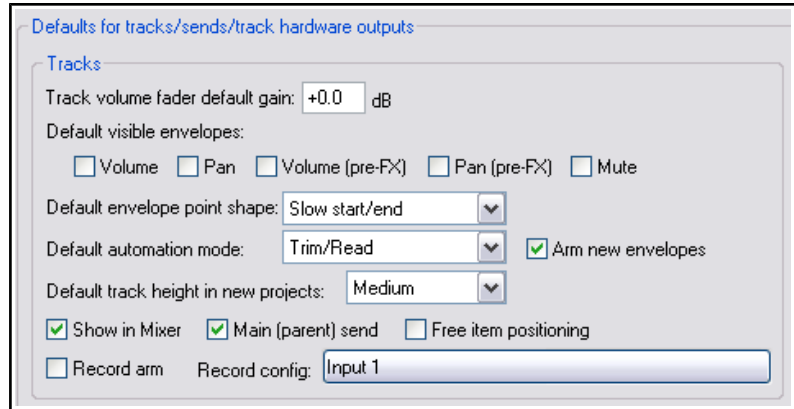

- Which Record Mode should be the default for new tracks.

Notice also that under **Options, Preferences, Appearance, Track Control Panels** there are settings which together determine how your track VU meters are presented.

For example, you can choose whether or not to **Show track input when record armed** and to **Make obvious that track input is clickable**. Disabling this latter option may improve the clarity of the display on your VU meters. Enabling **Show db scales on record armed track meters** and **Sticky Clip Indicators** helps you to monitor peak levels. MIDI users may wish to **Show MIDI velocity on track VU** and/or **Show MIDI output activity on track VU**.

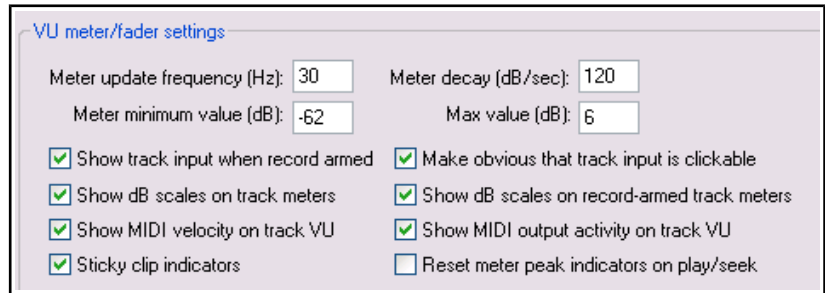

You can also specify whether to

Reset peak indicators on play/seek. If enabled, the numeric peak indicators on track and master VU meters will cleared when playback is restarted or the play cursor moved.

3.38 Projects with Mixed Formats

REAPER allows you to use different audio formats for different tracks in the same file. The default format for each new track that you create will be determined by your **Project Settings**. To change these for any track, simply right click over the track's VU meter, then from the menu choose **Track Recording Settings**.

You can choose any of the formats **WAV, AIFF, DDP, FLAC, MP3, OGG Vorbis, Video (GIF)** or **WavPack lossless compressor**.

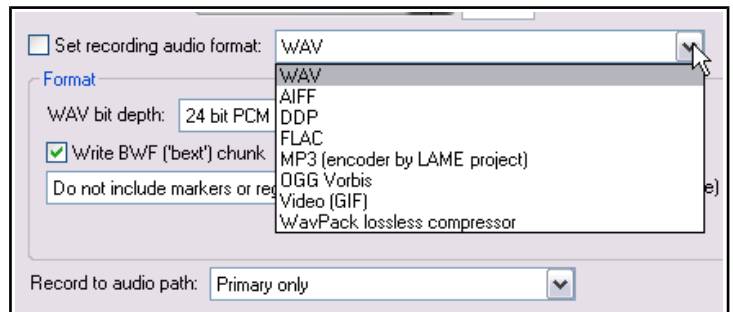

Depending on the format you choose, you will be presented with a range of options appropriate to that format.



Up and Running: A REAPER User Guide v 5.24

3.39 REAPER Audio Recording Checklist

The following checklist is for guidance only. In some cases you may vary the suggested order (e.g., you can switch on your PC and start REAPER before getting together your microphone and leads). In other cases the order is critical (e.g. you should always connect your microphone to your preamp before turning on the phantom power supply). If you are not sure, keep to the exact same sequence outlined here.

Item	Comment
Preparation	<p>Set up all external recording equipment needed (microphones, stands etc.).</p> <p>All faders and gain controls on mixer and/or sound device turned right down.</p> <p>Phantom power (if available) turned off.</p> <p>Everything connected that needs to be connected (e.g. microphone leads to mixer or sound device).</p> <p>Turn equipment on, but check volume on speakers isn't too loud.</p> <p>Connect headphones to headphone amp or sound device.</p> <p>If phantom power required (for condenser microphone), turn it on.</p>
PC Preliminaries	<p>Turn on PC and wait for Windows to open.</p> <p>Open REAPER with required project file. Save file.</p>
Project Settings	<p>Check recording format and settings – e.g. 24 bit WAV at 44100 Hz.</p> <p>Is a different format required for this track?</p> <p>Make sure Record Mode is set to Normal.</p>
Track Settings	<p>Named and armed for recording?</p> <p>Track Input Monitoring on or off?</p> <p>Use the Sound Card's direct input monitoring if available in preference to REAPER's.</p> <p>Record Input selected?</p> <p>Correct input channel selected?</p> 
Test Recording Levels	<p>Start low and work up.</p> <p>Record a small sample to test levels: the examples here show too low, too high and about right.</p> <p>It is better to be too low than too high.</p> 
Recording	<p>Press Ctrl R to record and again to stop recording when finished. Save media items. Press Ctrl S to save project file.</p>
Evaluating	<p>Unarm track before playing back recorded tracks to evaluate them.</p> <p>Especially if listening thru headphones, disable Input Monitoring (or turn faders and gain controls on the input device right down), to prevent live ambient sounds from being mixed in with your recorded material.</p>

3.40 Recording MIDI From Keyboard Check-List

Newcomers sometimes run in to trouble when recording MIDI from an external MIDI keyboard. If you find things aren't happening as you would like them to, here are some things to check:

- ◆ Is the keyboard sending MIDI on the required MIDI channel?
- ◆ Is the keyboard device enabled in Preferences for Input/Control?
- ◆ Is the keyboard selected as the input device for the track?
- ◆ If needed, is the correct MIDI channel from the keyboard selected?
- ◆ If needed, is the input mapped to the correct MIDI channel?
- ◆ Is record arm enabled?
- ◆ Is input monitoring enabled?
- ◆ If needed, is the plug-in "listening" to the required MIDI channel.

3.41 Recording an Internet Audio Stream

You can use REAPER to record an audio stream from the internet. Before doing so you should make sure that you are not in breach of any copyright restrictions. The exact method will depend on your hardware setup, including your sound card. Your sound card should include some sort of software for changing its settings. This may or may not have its own icon within the Windows Control Panel. If you are not sure how to access it, you can click on the Windows **Start** button, choose **Run**, then type **sndvol32 -r** and press **Enter**. In overview, these are the steps that you will need to perform.

1. Access your sound cards control software and modify its settings to select (depending on the options available) the required option. You should probably temporarily disable input from all other sources (Microphone, Line, etc).
2. Open your web browser and find the page containing the item that you wish to record.
3. Open REAPER, create a new file and add a track.
4. The next step may require a little experimentation. Depending on the equipment you are using, it might be necessary to change your **Options, Preferences, Audio, Devices** settings to **Direct Sound**. An example is shown here. These settings may not be the best for your particular system.
5. Arm your track for recording: be sure to select the correct input.
6. Press **Ctrl R** to start recording. In your web browser, play the item that you wish to record. When finished, stop recording and save your work.

Note: Don't forget when you have finished, to restore both your Sound Card Recording Control options and REAPER's Audio Device Preferences to their previous settings.

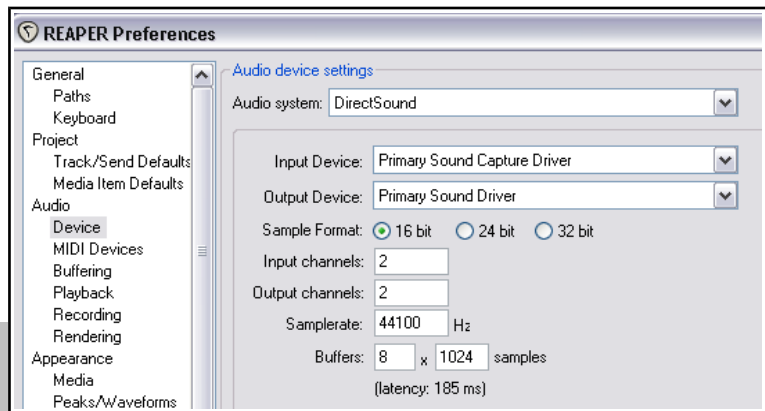

3.42 Converting Audio Media Item Format

In this internet age it is becoming increasingly common for musicians to want to collaborate on projects all the way across the world. Consider this scenario. You have a part recorded project of perhaps 50 or more 24 bit

wave files. In some far off land you have a friend who has offered to lay down a track such as a flute. You'd like to get your source files to her, so that she can do this for you, layering it down against whatever headphone mix best suits her.

However, your recorded material so far comes to over 3 GB and she doesn't have a particularly fast internet connection.

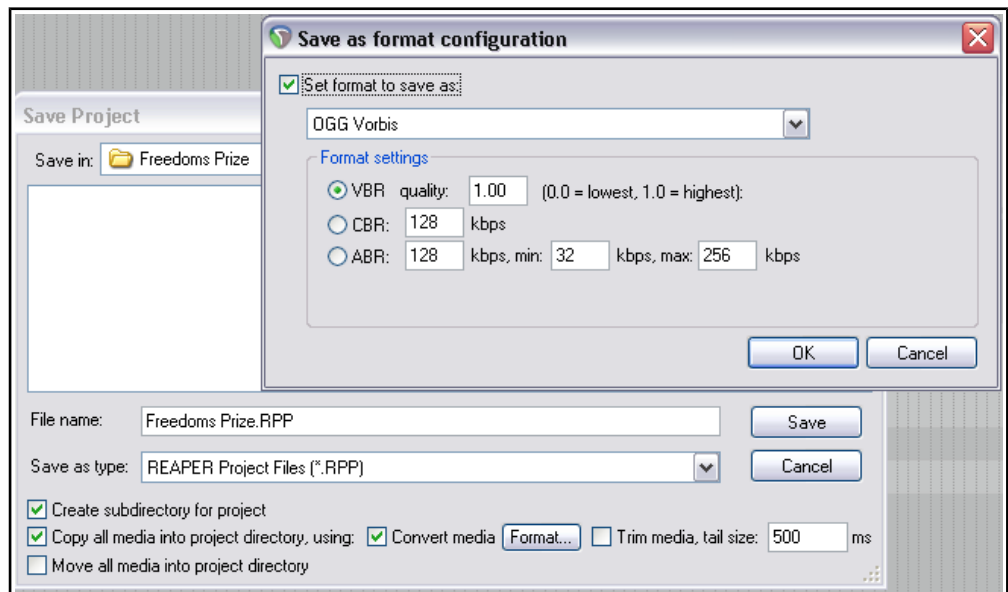

Up and Running: A REAPER User Guide v 5.24

One solution could be to convert the files to a compressed format and send her those. There's a quick way to do this, using the **File, Save project as ...** command. Choose this command and follow these steps.

1. If you wish, navigate to a required parent folder.
2. Enable the three options to **Create subdirectory for project, Copy all media into project directory,** and **Convert media.**
3. Click on the **Format...** button to display the settings box shown above.
4. Enable the option (top left) **Set format to save as.**
5. Select your required format (e.g. FLAC, MP3 or, as shown here, OGG Vorbis).
6. Specify your preferred format settings.
7. Click **OK** then **Save.**

All audio media items in the project will be converted to the specified format as they are copied across. The format of the original items will remain unchanged.

You can also convert and export selected individual media items from one format to another without having to convert the whole project. This topic is covered in Chapter 21.

3.43 Recording Live Windows Output

Windows users (Vista/7/8/10) can use WASAPI drivers to record live Windows output (for example, subject to copyright constraints, a YouTube video). This requires the use of feedback looping, so you should proceed with caution beyond this point. This is not recommended for beginners.

First, create a new project file. Display the project settings (**Alt Enter**) and on the Advanced page enable **Allow feedback routing.**

Next, display your **Preferences, Audio, Device** window and select **WASAPI** as your audio system. Select **Shared loopback** mode (see right). Your block size and sample rate will need to match those of your sound device, as set in the Windows Control Panel.

Finally, you simply add a new track and arm it for recording. You will probably want to set input to stereo.

Mute audio output from REAPER and press **Ctrl R** to record whatever you are currently playing in Windows. For example, this might be a YouTube video that you are currently listening to over your speakers.

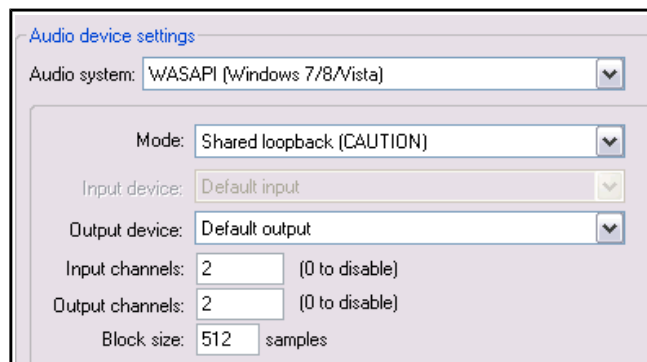

4 Importing Media: The Media Explorer

4.1 Introduction and Overview

Media Explorer display is toggled using the **View, Media Explorer** command, or the shortcut **Ctrl Alt X**. Its interface is shown in the diagram below.

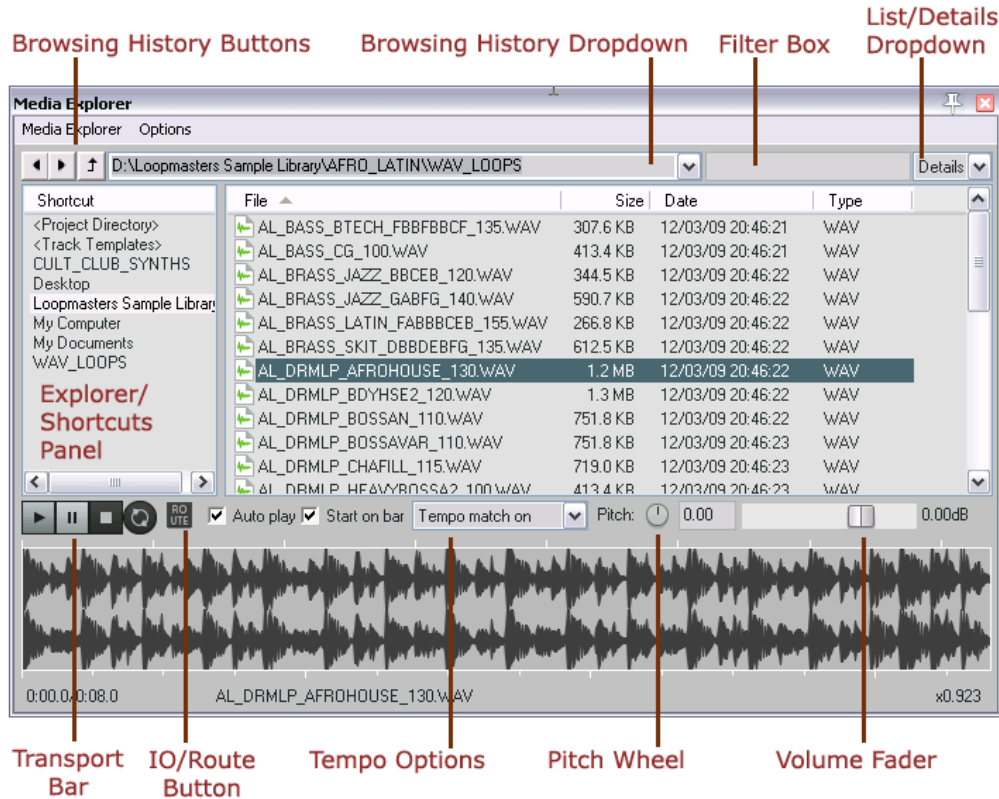

The REAPER main menu command **Insert, Media File ...** can be used to incorporate existing media items (such as MP3, MIDI and WAV files) into a REAPER project, but it is often easier and more flexible to use REAPER's **Media Explorer** for this purpose. The media explorer includes several additional features that help you to find the items that you want. Before exploring its features and its functionality, identify the following:

Explorer/Shortcuts Panel. This can be used to navigate your directories and files, rather like Windows Explorer. In addition, you can add here shortcuts to your favorite folders. Right-click in panel for menu toggle option to disable sort order.

Browsing History Buttons. A quick way of browsing back and forth thru your browsing history.

Browsing History Dropdown. This stores (and can display) a list of recently visited folders. You can select from this list to open any of these folders.

Filter Box. Use this to type a text string to filter the displayed file list.

List/Details Dropdown. Selects whether file details (size, date, etc.) or only file names are shown.

Transport Bar. Works with selected media item. Controls are Play, Pause, Stop and Repeat.

I/O Button. Directs output to any audio output, or to play thru any track selected in Arrange View.

Pitch Wheel. Adjusts pitch of selected item on playback. Use the options menu to set pitch shift knob range (by up to plus or minus 12 semitones) and behavior (continuous, quarter tones, or semitones).

Tempo Options. Allows you to set tempo match off, or on, or to half, or to double.

Volume Fader. Adjusts volume of playback of selected item.

Although more commonly used for finding and inserting media files, the media explorer can also be used to find, and open, existing .RPP project files.

Note that the media explorer is dockable. To do this, choose the **Options, Dock media explorer in docker** command (or use the right-click context menu).

4.2 Searching the Media Explorer

Although in some respects similar to Windows Explorer, REAPER's media explorer incorporates a number of extra features which can make searching easier and more flexible. Here is a general summary.

In order to do this ...	Do this
Browse thru your folders	Use the Explorer/Navigate panel in conjunction with the main panel. For example, click on My Computer (Windows) or Home (Mac) in the Explorer panel, then use the main panel to browse thru your folders, and to open any folder. Windows users have an option (Options menu) to Use Windows Explorer for browsing . If enabled, you can right-click over any column header and show extra columns such as Author, Title, Artist, etc. However, the Windows Explorer right-click context menu will be used instead of REAPER's context menu.
Navigate thru browsing history	Select from browsing history dropdown: all folders and directories visited during your current session will be displayed and available. Additionally, the buttons located to the left of this dropdown can be used to move back and forwards thru your browsing history.
Search/filter file list	Type text string (e.g. bass) in the unlabelled filter box (left of the list/details dropdown) to filter file display. Boolean search (AND, OR, NOT) is supported (e.g. kick OR snare). Use ^, \$ and quotes to match start/end/whole word – e.g. ^bass, bass\$, "bass" Delete the text string to remove the filter.
Manage folder/file display (Windows)	Click on any column header to sort by that column – e.g. File name or Date. Click again to reverse the sort order. Right-click on any column header for option to show/hide any columns. Drag/drop header left or right to change column order. If Custom tag column is displayed, double-click in this column for any file displayed to edit the custom tag.
Restrict search	The Options menu includes several features which can be toggled on or off to restrict file search according to any of the following: <ul style="list-style-type: none"> • Show all files • Show leading paths • Search in search fields (e.g. Title, Artist, Album, Year, Genre, Comment. BWF Description) • Search in leading paths • Search in metadata • Search in subfolders • Include matching subfolders (shows sub-folder names in search results) • Whether to Update searches only when the ENTER key is pressed
Add folder to Shortcuts list	Right click on the folder name in the main panel, then choose Add to shortcut list from the menu. This folder will now be displayed in the explorer/shortcuts panel. You can select this shortcut at any time to display its contents. 
Remove a shortcut	Right-click on the shortcut name (in the explorer/shortcuts panel) and choose Remove selected shortcut from the menu.

4.3 Media Item Preview

The media explorer allows you to preview media items before you decide which to insert into your project. By default, an item is automatically played when you select it. You also have a number of options available which determine exactly how the preview feature will behave.

- The **Auto play** and **Start on** bar options are enabled/disabled by tick boxes close to the transport bar.
- On the **Options** menu there is an option to **Auto advance to next file after preview**. This will only work if the repeat function on the transport bar is set to off. Other preview toggle options include **Auto-stop preview after adding media**, and **Display preview position in tenths of seconds**.
- The **Transport Bar** buttons (L to R) are Play, Pause, Stop and Repeat. The horizontal fader adjusts the volume of playback.

4 - Importing Media: The Media Explorer

- Click anywhere on the displayed waveform to play back from there. Use the mousewheel to zoom in and out of the media peaks horizontally. To adjust the height of the waveform preview, click and hold the mouse on the top edge of the preview area, then drag up or down.
- You can also scroll by holding **Shift** while you drag the mouse left or right. You can mark any time selection by clicking and dragging over the preview display, and move a selection left or right by holding **Alt** while you drag the mouse.
- Display of waveforms can be turned on and off in the **Options** menu, **Always show waveform peaks for selected media**.
- Other playback/waveform **Options** include **Display preview position in tenths of second** and **Auto stop preview after adding media**.

Enabling **Options, Auto advance to next file after preview** will cause all files displayed in the media explorer main window to be played in sequence, provided that the repeat button on the transport bar is set off.

- By clicking on the **I/O** button (next to Transport Bar), you can direct the Preview to any audio output. The I/O button menu also includes an option to **play the previewed item through a selected track**.
- The **Pitch** rotary control adjusts the pitch of the item being previewed. Double-click to reset. The **Options** menu **Pitch shift knob range** command allows you to set its range to +/- 2, 6 or 12 semitones and to set its **behavior** to **Continuous, Quarter tones** or **Semitones**.
- The **Options** menu includes two toggle options to **Preserve pitch when tempo matching** and **Reset pitch shift when changing media**.
- To avoid possible clashes of tempo, you can select an option (including **Tempo Match Off** and **Tempo Match On**) from the drop down list in the preview area. There is also a toggle option to **Start on Bar**.

4.4 Inserting an Audio File as a New Take or Item

Selected media items can be inserted into the current project from the media explorer's main window by right-clicking over the file name and choosing from the options offered (see below). The choices are:

- Insert into project** (on currently selected track, at current cursor position)
- Insert at time selection (stretch/loop to fit)** (if a time selection is currently active)
- Insert into project on a new track** (at current cursor position)
- Insert as take in selected item** (requires an item to have been selected)
- Use as media source for selected item** in place of that item's existing media source
- Use as media source for selected item (stretch/loop to fit)** in place of item's existing media source
- Preview** (plays item but does not insert it).
- Show in explorer (Windows)/finder (Mac)**

A quick way is to double-click on the file name, or to select it and press **Enter**, or to drag and drop – but it isn't quite that simple! Using any of these methods will cause a default action to be automatically applied.

You can determine that default action by using the media explorer's **Options, Default action (double-click or Enter key)** command. This menu is shown here (below right). It might seem strange at first, because it includes options for both media files and (.RPP) project files, both of which will most likely have different needs.

Choose one of **Insert media** (if media item) or **open project** (if .RPP project), **Start preview**, or **Do nothing**.



Specify for media items whether to **Insert media on selected track** or **insert media on new track**.

Set your preference for the toggle option **Enable looping when inserting selected portion of media**.

Specify for project (.RPP) files whether to **Open projects in current tab** or **Open projects in new tab**.

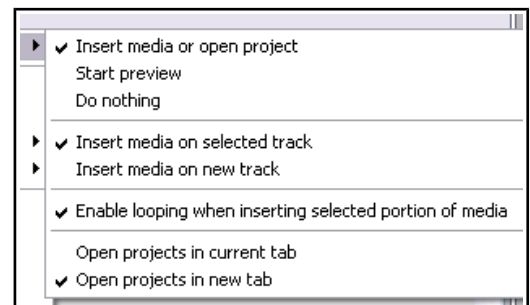
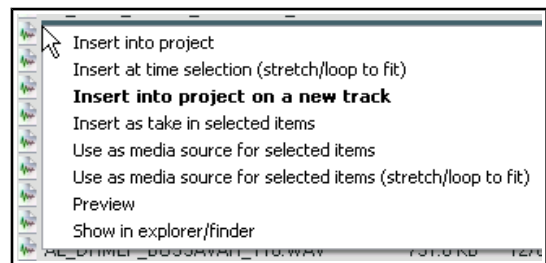
As well as (or instead of) importing entire individual media items, the media explorer makes a number of other choices available. These are explored in the table below:

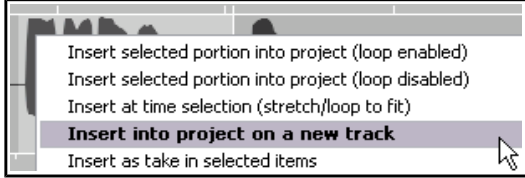

In order to do this ...	Do this
Insert part of a media item into a project	<p>Select the required portion of the waveform in the preview window.</p> <p>Right click over the selected portion and choose one of the items from the context menu.</p> <p>The item can be loop enabled or disabled. It can be inserted at an existing time selection, on a new track, or as a new take on a selected item.</p> <p>Alternatively, the required portion can be dragged and dropped into the project, in which case your default settings will be applied.</p> 
Insert multiple items at once See also note below.	<p>Use Ctrl click to build your required selection in media explorer.</p> <p>Right-click over the selection and make your choice from the menu.</p> <p>Alternatively, you can drag and drop the selection into the project. Unless you have changed the default setting, you will then be prompted to select whether you want the items inserted on one track or on separate tracks.</p> 

Note: The **Media** screen in the **Preferences** window includes a setting for default behavior when inserting multiple items. These are:

Insert in one track (advancing time) – each is placed one after the other in the same track.

Insert across tracks – each item is placed in a separate track, all starting together.

Decide automatically – if files are of the same length (file size) they will be placed in separate tracks, otherwise they will be inserted sequentially in the same track.

Prompt user – you will be prompted each time to specify your preference.

If in doubt, set this to **Prompt User**. Other useful options include whether or not imported media items should be copied to the project media directory. See Chapter 22 for more details.

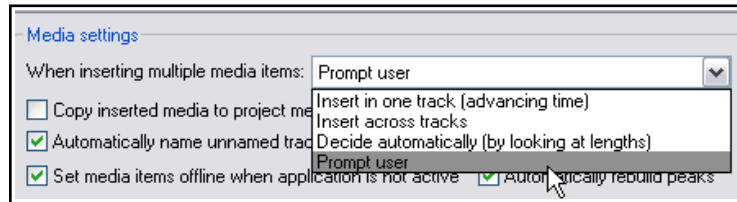

4.5 Creating and Using a Media Explorer Database

Within the media explorer shortcuts panel you can create your own database (or databases) to further customize how your samples and media files are organized and displayed. One benefit of this is that it lets you display together files that might be stored in different folders.

For example, you might use different folders for various types of drum samples (snare, kick, hi hat, etc.).

There might, however, be times when you would want to see the contents of these various folders listed together. To do this, you could create a database called "Drums Various" and add all of these folders to that database.

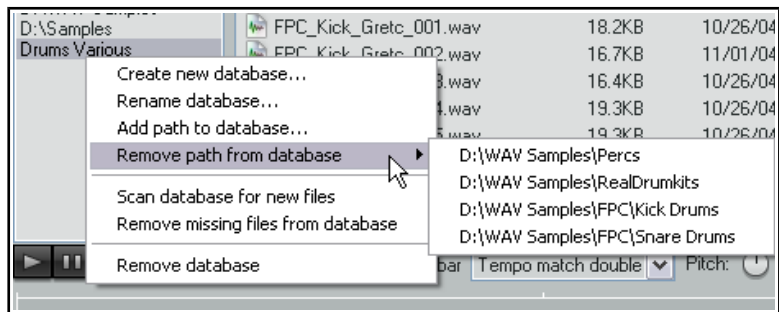

Databases are set up and managed using right-click context menus in the **Shortcuts** column.

4 - Importing Media: The Media Explorer

In order to do this ...	Do this
Create a new empty database	Right-click over empty area in Shortcuts column. Choose Create new database... from menu. Type name, press Enter .
Add folder contents to database	<i>EITHER ...</i> Select database in Shortcuts column. Right-click over its name and choose Add path to database ... from menu. Navigate to required folder, select it and click on OK . Repeat this to add more folders. <i>OR...</i> Drag and drop folder from windows explorer, or media explorer's main window on to the database name in the shortcuts panel.
Add file(s) to database	Select file(s) in windows explorer or media explorer's main window, then drag and drop to the database name in the shortcuts panel.
Change shortcut name of folder in database	Right-click on folder name in shortcut panel, choose Rename shortcut... Does not change folder name on hard disk.
Create a new database from a folder	In main media explorer window, right-click on folder, choose Make database from folder .
Remove a folder contents from database	Select database in Shortcuts column. Right-click over its name and choose Remove path from database... from menu. Navigate to required folder, select it and click on OK .
Remove item(s) from database	Select item(s) in media explorer window. Right-click over selection, choose Remove items from database .
Change database name	Select database in Shortcuts column. Use Rename database... command on context menu. Does <i>not</i> erase items from disk.
Update database contents to reflect changes in folder contents	Select database in Shortcuts column. From context menu use Scan database for new files to find and add new files, Remove missing files from database to remove deleted files.
Remove a database	Right-click on database in Shortcuts column, choose Remove database .

Media explorer databases can be included in your **export configuration** settings (**Options, Preferences, General**): see also Chapter 22.

4.6 Replacing an Item's Source Media

You can select an item in the media explorer and use it to replace the source media in an existing item (or number of items) in the current project. This can be done from the media explorer menus or by drag and drop.

To replace source media using the menus:

1. Select the media item (or items) in the project.
2. In media explorer, select the required replacement item.
3. Right-click on this item and from the menu choose either **Use as media source for selected items** or **Use as media source for selected items (stretch/loop to fit)**.

To replace source media using drag and drop:

1. Select the item in media explorer.
2. Hold **Ctrl Alt** while you drag and drop to the media item whose source is to be replaced.
3. The dialog box shown here will pop up. You can choose **Insert new media item that overlaps target media item**, **Add source media as new take in target media item**, **Replace target media with source media** or (if there is more than one instance of the item) **Replace all x occurrences of the target media with source media**.

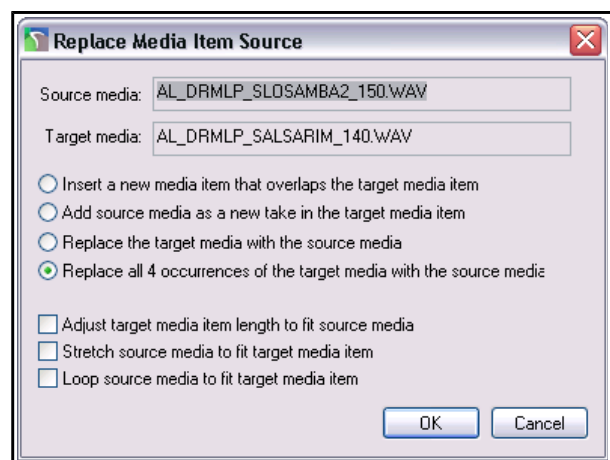

- Specify your preference as to whether to **Adjust target media item length to fit source media**, **Stretch source media to fit target media item**, or **Loop source media to fit target media**.

Note: This method can be used to replace an existing source media item with *part* of another item. After selecting the replacement item in media explorer, click and drag in the waveform preview area to select the required part of that item, then follow steps 2. to 4. above.

4.7 Importing MIDI Files

To preview a MIDI file in media explorer, first create an empty track in your project and insert a virtual instrument or synthesizer into that track's FX chain. You can then select any MIDI file in the media explorer and preview it. You can also select any part of a MIDI file to import: use the same techniques as those described earlier in this chapter. Right-click over the file name to choose one of the insert options, or just drag and drop. You can also import MIDI files by dragging and dropping from Windows Explorer, or by using the **Insert, Media file...** command.

MIDI File Types

There are two main types of MIDI file, Type 0 and Type 1. REAPER recognises both. In Type 0 files, all the MIDI events and data are stored in one track, but individual channel data is retained. A single track Type 0 MIDI file can contain up to 16 channels of data on the one track. Type 1 files can contain any number of tracks, with each track containing data on one or more channels. Type 1 is more suited to larger arrangements than is Type 0. For example, you may wish to use several drum parts on a single channel, but with each on a separate track.

Importing Type 1 MIDI Files

To understand how REAPER handles imported MIDI items, let's work thru some fairly simple examples. We'll take the example of a simple Type 1 MIDI file that was created with two tracks. Track 1 contains data on Channel 1 only, and track 2 contains data for two different instruments on channels 2 and 3. There are a number of possibilities as to how we might wish to import this into our REAPER project:

- We might want each track/channel combination imported on to a separate track (three tracks in all).
- We might wish to keep the original structure and import the file as two tracks.
- We might want all three channels of data imported on to a single track.

Let's see how we might approach this. This example assumes that you have your Media/MIDI preference for **Import multichannel MIDI files** set to **Always prompt ...**

1. As you are importing a type 1 multitrack MIDI file into REAPER, you are asked if you wish to **Expand the MIDI tracks to new REAPER tracks**.

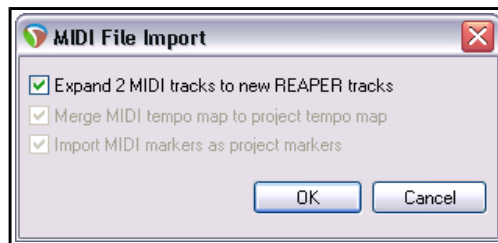

2. If you enable this option and click on **OK**, you will then be presented with two further options.

3. If you select **Single-channel items on multiple tracks**, a separate REAPER track will be created for each MIDI file/track combination that contains MIDI data – in this example, three (because our example MIDI file contains data on channels 1, 2 and 3). The imported file will appear similar to this (example 1):

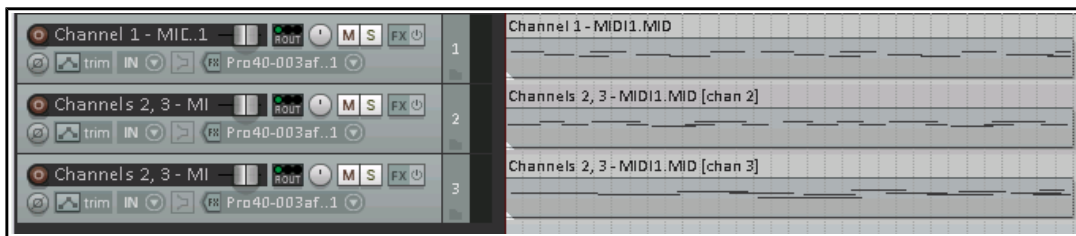
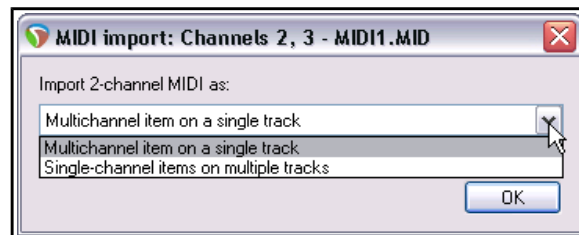

If, however, you instead select **Multichannel item on a single track**, then you will get this (example 2):

4 - Importing Media: The Media Explorer

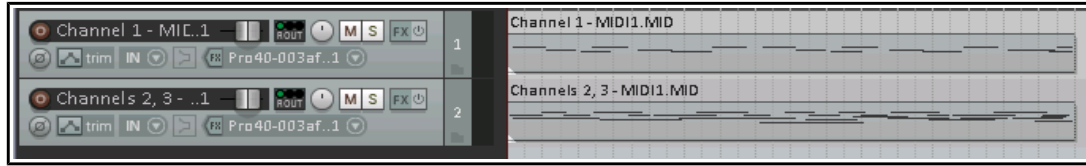

This reproduces the track/channel structure of the imported MIDI file.

Let's now go back to step 1. (above). If we deselect the option to **Expand the MIDI tracks to new REAPER tracks**, and then select **Multichannel items on a single track**. In this case, we get this (example 3):



All the MIDI items are placed in their correct channels on to a single track. This gives us the opportunity if we wish to do something quite clever. You can right-click over the item and choose **Item processing, Explode multichannel audio or MIDI items to new one channel items**. This causes this to happen (example 4):



The originally imported MIDI item is retained but muted, and its track becomes a folder which contains the newly exploded MIDI items (one for each channel of MIDI data). Folders are explained in detail in Chapter 5: for now, just note that you could insert a virtual instrument and/or other plug-ins such as ReaControlMIDI (see Chapter 13) in that folder's FX chain and use them to control and play back all of the MIDI items.

Importing Type 0 Files

This next example examines your options when importing a single track type 0 MIDI file into REAPER. Let's assume that this file contains MIDI data on, say, 3 channels.

When you import the type 0 MIDI file into your project, you are not prompted with the question about expanding MIDI tracks: the file by definition contains only one track, and so the question would be irrelevant. Instead, you are straight away asked whether you wish to place a **Multichannel item on a single track** or **Single channel items on multiple tracks**.

By way of illustration, regardless of how many channels contain MIDI data, choosing the single track option would produce an outcome similar to that shown below (example 5). As in example 4, this item can be exploded into a folder containing a separate track for each channel if you wish.

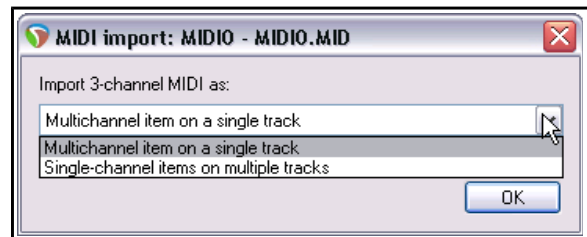

If (at the MIDI import prompt) you choose the multiple tracks option, you will get a separate track for each channel that contains MIDI data. Thus, an item containing data on three channels would produce this:

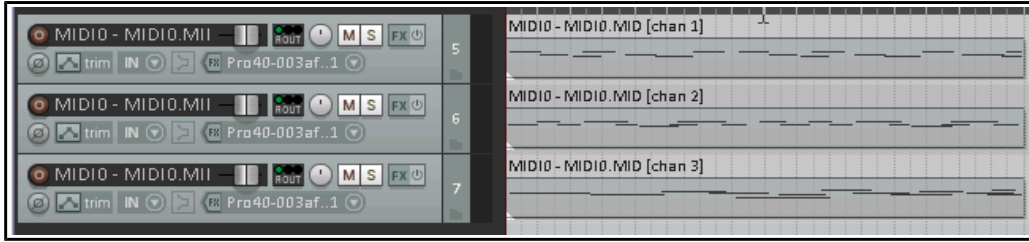

4.8 Importing Multichannel Audio Files

Multichannel audio files are imported into REAPER in exactly the same way as any other item. An example of such a file (in this case six channels) is shown here.

You can split such a file into its individual channels, to produce one track per channel. This allows for each channel to be edited independently of the others. To do this, right-click on the item and choose **Item processing, xplode multichannel audio or MIDI items to new one channel items**. This would produce a result such as that shown above.

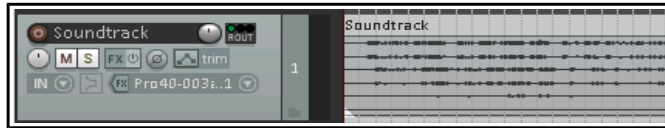

4.9 Import Formats

Media files can be imported into REAPER in any of the following formats.

CD Audio (.CDA)

DDP (.DAT)

FLAC (.FLAC)

MIDI (.MID)

MIDI System Exclusive Message
(.SYX)

MIDI Karaoke (.KAR)

MPEG Audio (.MP2, .MP3)

OGG Vorbis (.OGG, .MOGG)

Recycle (.RX@, .REX, .RCY)

AVI Video (.AVI)

MPEG Video (.MG, .MPEG)

WMV/WMA Video (.WMA, .WMV)

MK Video (.MKV)

LCF Capture Video (.LCF)

Quicktime (.MOV, .QT, .M4V, .MP4)

WebM (.WebM)

WAV (.WAV, .W64, .BWF)

AIFF (.AIF, .AIFF)

WAVPACK (.WV)

4.10 Importing Media from Audio CD

To import material from an audio CD (such as you might play on a CD player):

1. Insert an audio CD into your PC CD drive and wait for it to be read.
2. Display media explorer, select **My Computer** in the left panel, then double-click in the main panel on the letter which represents your CD drive. The contents of the CD will be listed.
3. To play (preview) any track from the CD, right click over that track then choose **Preview** from the context menu (see above). Depending on what other software is on your computer, you may also see some non-REAPER related commands below this.
4. To insert the contents of a track into your project as a media item, right click over that track and choose one of the other commands from the menu. Each of these commands works as explained earlier.

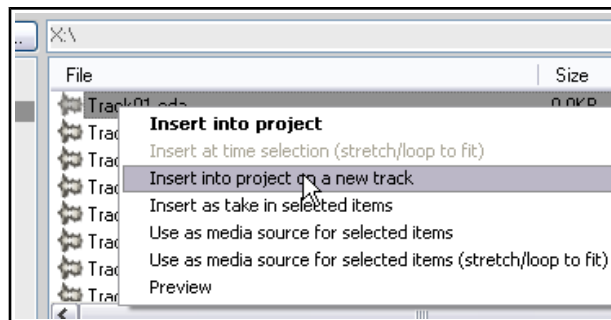

Alternatively, you can double-click on the item to insert it into the currently selected track, or drag and drop to insert either on to an existing track or to a new one.

5 Project Arrangement Basics

5.1 Managing Tracks

In Section 2, we introduced some very basic REAPER track management features, such as Volume, Panning, Mute and Solo. In this section, we will be exploring these features in more depth, as well as introducing several others, including moving and removing tracks, the use of track folders and track parameter grouping.

Many of the commands and actions involved in track management are available from the menu that is displayed when you right click over any track number. The illustration (right) shows these.

Remember that at any time you can use **Ctrl Z** to undo your last action. REAPER's Undo capabilities are described in more detail later in this section.

Tip: Before continuing, you might wish to open the supplied project file **All Through The Night.RPP** and save it to a new name such as **All Through The Night EDITS.RPP**. You can then use this file to try out and experiment with some of the ideas presented in this section.

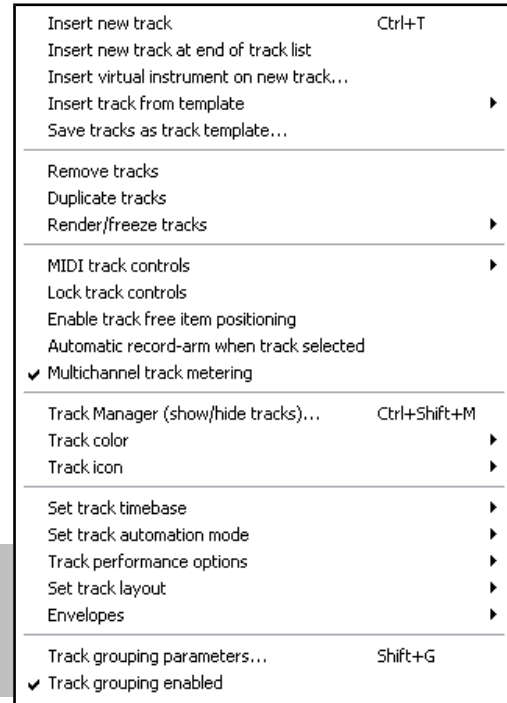

Basic Track Management

A number of techniques can be used for carrying out these various track management tasks.

Task	Method
Move a track up or down the track order	Click on the track number, then click and drag the track up or down the track list, then release the mouse. Media items are moved with the track.
Move two or more adjacent tracks up or down	Click on the track number for the first track, then hold Shift while clicking on the track number(s) of the last of the tracks that you wish to select. Then click and drag up or down. Again. all media items are moved with the tracks.
Delete a track	Click on or around the track number, then press Delete , or right click and choose Remove tracks . All media items are removed with the track.
Delete two or more tracks	Use Ctrl with the left mouse click to make your selection, then press Delete , or right click and choose Remove tracks . All media items are removed with the tracks.
Copy a track as the next track	Right click over the track number, choose Duplicate selected tracks . All media items are duplicated with the track. To do this with more than one track, select all required tracks first.
Copy a track to a specified location	Click on the track number. Press Ctrl C . Move to the required location then press Ctrl V . All media items are duplicated with the tracks. To do this with more than one track, select all required tracks first.
Display the Master in Track View	Right click anywhere in the Track Control Panel area, below the last track. Choose Show master track , or use the keys Ctrl Alt M to toggle.
Make the Track Control Panel wider/narrower	Click and drag right/left on the boundary between the TCP and the arrange area. As the TCP becomes narrower, some controls may disappear from view and faders may change to knobs.

5.2 Track Control Modifiers

Four of the items used when auditioning tracks are the **Volume**, **Pan**, **Mute** and **Solo** controls. These controls were introduced in Chapter 2.



The **Width** control is also shown here. A width

control is displayed only if you select the stereo pan or dual pan law (from the pan fader right-click menu). This will be discussed in Chapters 10 and 11.

By default, volume and pan faders control audio output. If you wish instead to use them for data on MIDI channels for any track(s) you should first select the tracks, then right-click over the track number and choose **MIDI track controls** then one of the **Link track volume/pan to MIDI** options from the menu (see Chapter 13).

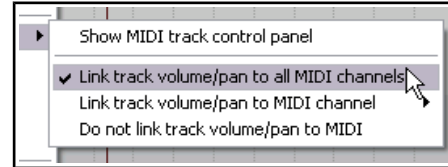

Volume and Pan Controls

Modifier Key	with Volume Fader	with Pan Rotary
Alt	When mouse is released, fader returns to its original position.	When mouse is released, fader returns to its original position.
Ctrl Shift	With more than one track selected, only the current track is affected.	With more than one track selected, only the control for the current track is affected.
Ctrl	Allows more precise control of fader level.	Allows more precise control of fader level.
Double click	Reset to zero.	Reset to centre.

Mute and Solo Controls

Modifier Key	with Mute Button	with Solo Button
Shift	When more than one track is selected, only the current track is toggled.	When more than one track is selected, only the current track is toggled.
Ctrl	Clears all mutes.	Clears all solos.
Alt	Unmutes selected track(s), mutes all others.	Solo selected tracks only, excludes output from any sends.
Ctrl Alt	Mutes selected track(s), unmutes others.	Solo exclusive: Solos selected track(s), unsolos all others.
Ctrl Shift	Not applicable	Toggles <i>Solo Defeat</i> mode for the track or track selection. See comments below.

Note: When a track is muted, a small red **M** icon is shown in its VU meter. A **!S** icon indicates that the track is not being heard because another track or tracks is or are soloed.



Solo Defeat

Solo Defeat can be used to ensure that a track will still be heard even when another track or track selection is soloed exclusive.

The Mute and Solo control context menus

The options shown above are also available by right-clicking over the Mute and Solo buttons respectively. These context menus are shown on the right. They can be applied to an individual track or to a selection of tracks.

Bulk Track Mute/Solo

To mute or solo a range of tracks in one action, click and drag in the TCP from the mute or solo button of the first track in the range to the same button on the last track in the range, then release the mouse button. Repeat this action to unmute/unsolo all muted or soloed tracks within a range.

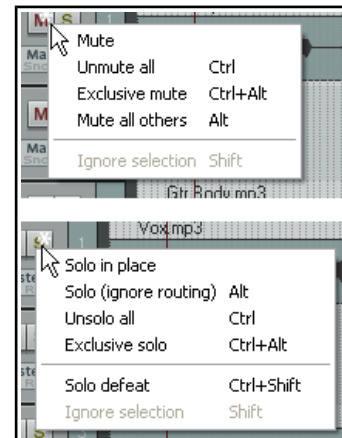

Volume and Pan Faders

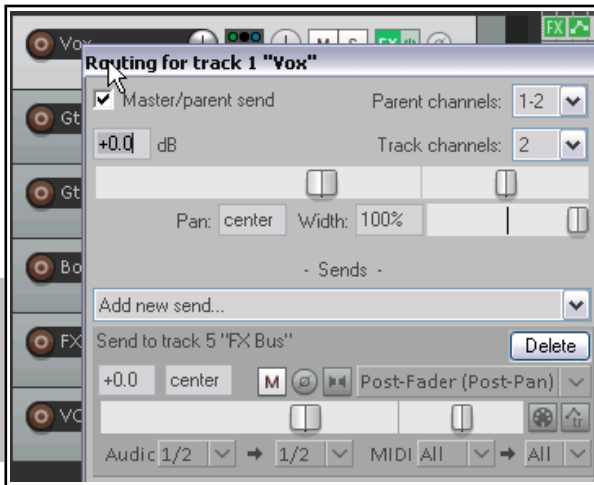

Right clicking over the volume fader of any track or folder will open a window displaying volume and pan faders not only for the track itself but also for any sends and receives associated with that track. An example is shown here.

Right clicking over the Pan fader opens a window which can be used to change that track's pan law. This subject was discussed in Chapter 2.

Tip: By default, double-clicking on a track number in the track control panel will cause all media items in that track to be selected. You can change this behavior if you wish on the **Mouse Modifiers** page of your **Preferences**. For more information about customizing mouse modifiers, see Chapter 15.

5.3 Solo In Front

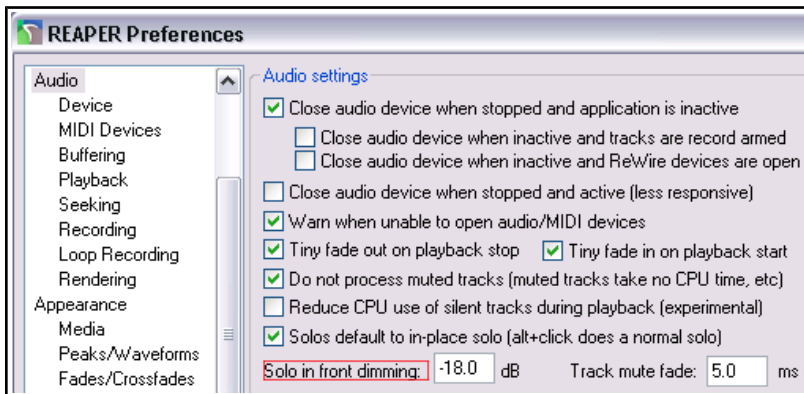

Solo in front allows you to hear the other tracks quietly in the background when one track or a track selection is soloed. This feature is toggled on and off by the **Options, Solo In Front** command.

The level at which the background tracks are heard can be specified via the *Options, Preferences, Audio* settings page. This setting (in the example shown it is set at 18dB) determines the extent to which the background mix is

reduced. This means that the higher the setting the quieter will be the background mix and vice versa.

5.4 Auto-Naming Multiple Tracks

In one action, you can create and automatically name any number of tracks that serve a common purpose – for example, a number of backing vocal or percussion tracks. This can be done using the **Insert, Multiple tracks...** command.



In the example shown here, we are creating three Backing Vocals tracks (B Vox) at the end of the current track list. These will be automatically be named B Vox 1, B Vox 2 and B Vox 3, as shown.

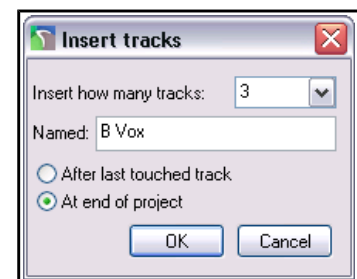

5.5 Searching the Preferences Settings

You have already come across a number of REAPER's preferences settings. For example, we have looked at some of the preferences settings for Audio Devices, MIDI Devices, Recording and Projects. The more you work with REAPER, the more you will realise how very many preferences settings there are. In fact, there are so many that it can sometimes be difficult to remember which page you need for a particular setting.

Up and Running: A REAPER User Guide v 5.24

To help you there is a text box and a **Find** button near the bottom of the Preferences window. You can enter any word or phrase in the box, click on **Find** and the first occurrence of that word or phrase will be shown. If this isn't the item that you're looking for, each time you click the **Find** button the next occurrence of that word or phrase will be shown. The item will be displayed with a colored highlight.

In the example shown here, a search for **sends** has turned up some information about various options for setting the default parameters for track sends when they are created.

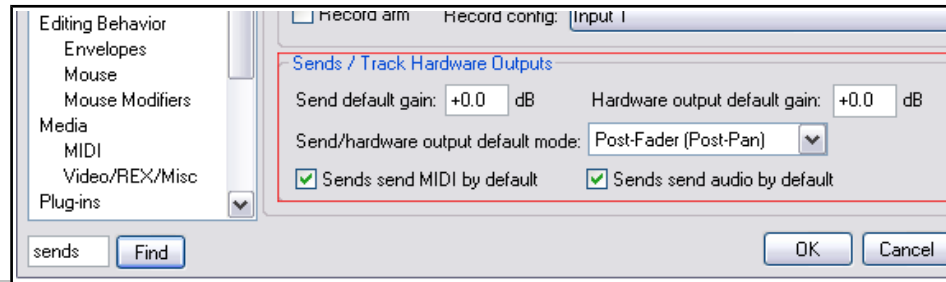

Tip: By default, double-clicking on a track number will cause all media items on that track to be selected. You can change this, and/or add mouse modifiers of your own via the **Editing Behavior, Mouse Modifiers** preferences page. For example, you could assign **Alt Double-click** to the action View:Toggle track zoom to maximum height. Instructions for customizing mouse modifiers can be found in Chapter 15.

5.6 Track Colors

You can use color as an effective means of helping you visually identify different tracks. To do this, simply select the track (or tracks) in the Track Control Panel, then right click, choose the **Track Color** command, then use any of these commands from the submenu:

Command	Effect
Set tracks to custom color...	Opens a Color Selection dialog box for you to select a color for the track's media items.
Set tracks to random colors	Sets the media items for each track in the selection to a different randomly chosen color.
Set tracks to one random color	Sets the media items for all tracks in the selection to the same randomly chosen color.
Set tracks to default color	Restores the track's color to the default for the current color theme.

The illustration (right) shows an example of how the **Colors** interface (displayed by choosing the **Set tracks to custom color...** command) can be used to specify different colors for different tracks and groups of tracks.

On the **Appearance** page of your Preferences settings (Options, Preferences) you can use the **Track Control Panel** options to apply your colors to the track label background, the track panel background, or both.

How the colors will be displayed for your track media items will depend upon which options are selected on the **Appearance, Peaks/Waveforms** page of your Preferences settings.

Waveform peaks and/or the Background can be selected. You can also set the color strength (between 0 and 4) for both selected and unselected tracks. More details of these and other Appearance options are listed and explained in Chapter 22.

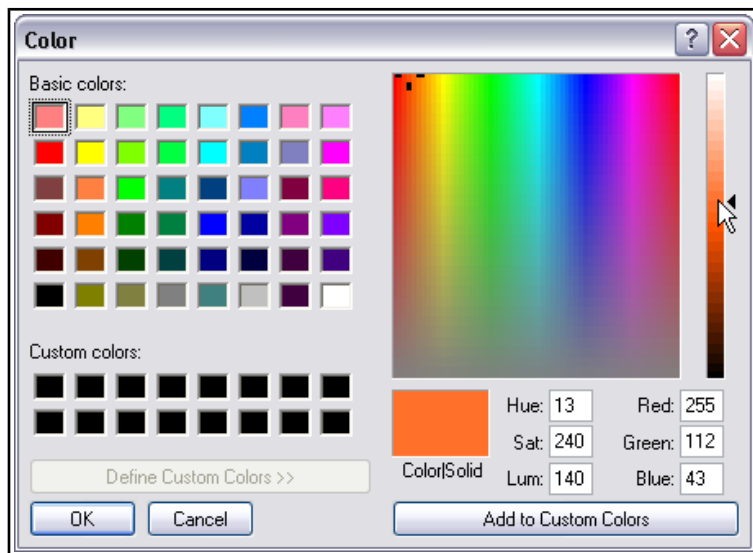

5.7 Color Themes

REAPER also supplies a number of color themes that you can use to present your projects attractively.

To select from the themes supplied with REAPER, use the **Options, Themes** command. You can modify the colors and other characteristics of your preferred theme by selecting the action **Show theme tweak/configuration window** from REAPER's action list editor. More details of this can be found in Chapters 10, 11 and 13. In addition, a very large number of complete themes are available in the **REAPER stash**. These are available for free download at stash.reaper.fm You can also visit the REAPER User Forums for more themes. *Be aware, however, that changing themes can also result in changes in such areas as your track control panel layout.*

5.8 Track Icons

Icons can be added to tracks as you wish. You can drag your own .PNG or .JPG files from Windows Explorer and drop them on to any track in the track control panel, or right click over the track number and choose **Track Icon** then **Set track icon...** from the track menu to use any of those supplied with REAPER. This opens the **Load Image Resource** dialog box. You can view the icons as thumbnails (shown here), tiles, or a list. Make your selection and click on **Open**.

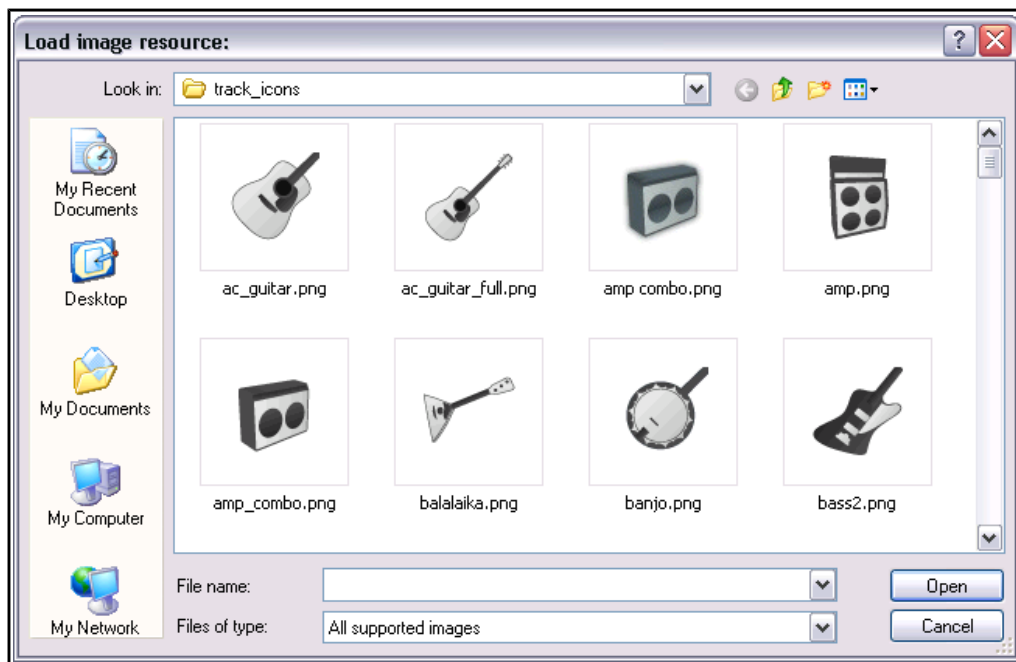

Shown left is an example of a project which uses track icons. Remember that if you create a track template from a track which displays an icon, then the icon will be saved with the template. To display these icons also in the Mixer, open the Mixer, display its menu and choose **Show Track Icons in Mixer**. To remove icons from any track or selection of tracks, first select the tracks (in either the track control panel or the mixer) then right-click over any selected track icon and choose **Remove Track Icon** from the menu.

If you don't care for the icons supplied with REAPER – or you can't find what you want – you can download more track icon sets from the REAPER stash, at stash.reaper.fm

5.9 Track Layouts

Different people and different projects have different needs. That's one reason why REAPER's default theme makes available to you a selection of different track layouts. You can select any of these for your tracks and, indeed, if you wish even use different track layouts for different tracks. This topic is examined in more detail in Chapter 12, where we deal with track, mixer, transport and envelope layouts. Here is a basic introduction.

First select the track (or tracks), then right click over the track panel. From the context menu choose **Set track layout** then **Track panel**, then select from the list. New layouts are developed and added or modified from time to time. Be prepared to explore! Some examples are shown below:



Default: the theme default track layout.



Default + value readouts: Volume and pan settings displayed as text.



Small: uses less screen real estate.



Large: easier to read but uses more real estate.



Standard media: with horizontal volume fader (rather than rotary).

5.10 Headphone Monitoring

While you are listening to and evaluating your various recorded items, it's usually recommended practice to use the monitors (speakers) in your studio or control room. However, you may wish also to use headphones from time to time, perhaps for those occasions when you need to focus in detail on a particular track or media item. Assuming that you have a PCI sound card or other audio device (Firewire or USB) which supports multiple outputs, here's a neat little trick.

1. Assign **Output Aliases** to your outputs, as explained in Chapter 1.
2. Display your Routing Matrix and assign the output from the Master to the Control Room speakers.
3. Put on your headphones.
4. As you play the song, click on the appropriate cells on the routing

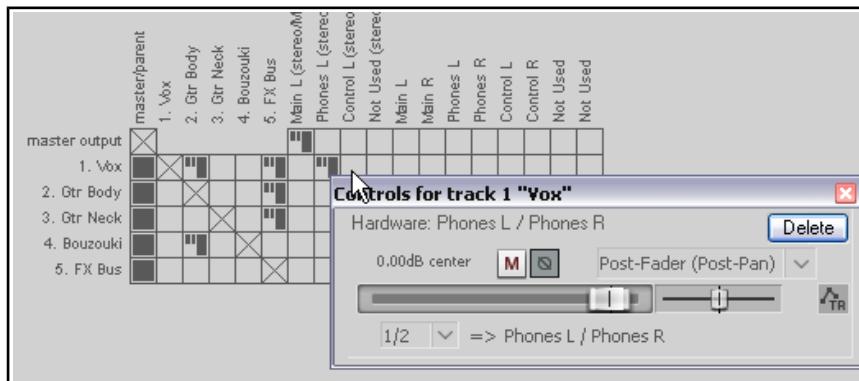

matrix to also direct any particular track on which you wish to focus to your headphones. Of course, you can change from track to track, or add as many or as few as you want at any time.

In the example shown (above), the entire mix (from the Master) is being heard thru the Main Speakers, but only track **1 Vox** is also being heard thru the headphones.

Remember that you can right click over this grid cell to display the controls for this send (such as Volume). This can be also a good technique to use when you have with you a musician who wants to particularly hear her own track while you are mixing!

When you are mixing down, you might not wish to see all of the available routing information available – it can get quite complex. You might wish to keep the routing matrix display as simple as possible for the job in hand. For example, if you are focussed purely on mixing, you might not need to see all the various input assignments.

Right clicking over the background area lets you customize its display. In the example shown here, by unchecking **Show audio hardware as sources** we have simplified the display. If you have installed ReaRoute, consider also disabling the options to **Show ReaRoute as destinations** and **Show ReaRoute as sources**.

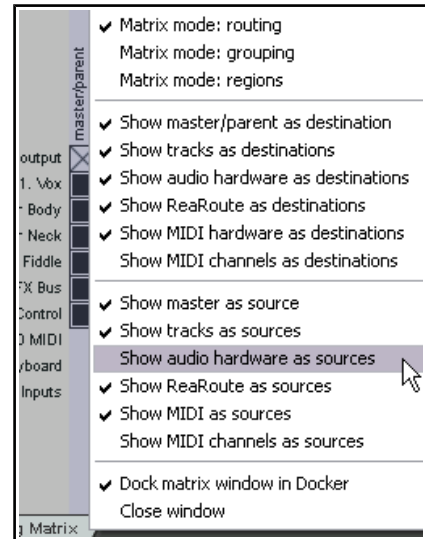

5.11 Creating a Headphone Mix

Provided your sound card includes at least two pairs of outputs, we can make the process of headphone monitoring easier and more flexible by creating a headphone mix. This is how it is done.

1. Connect your Headphones to your Headphone Amp, and your Headphone Amp to one pair of outputs.
2. Create a new track and name it **Headphone Mix**. Create sends to this track for any and all tracks that you want to be able to monitor thru your headphone mix.
3. Choose the **Options, Preferences** command, select the heading **General** then click on the **Advanced UI/System tweaks ...** button. Enable **Allow track envelope/routing windows to stay open**.
4. Click **OK** then **OK** again to close the Preferences window.
5. Select your **Headphone Mix** track and open the **Routing Window**. Add an **Audio Hardware Output** to the paired outputs to which your Headphone Amp is connected. Disable the **Master/Parent Send** for this track.

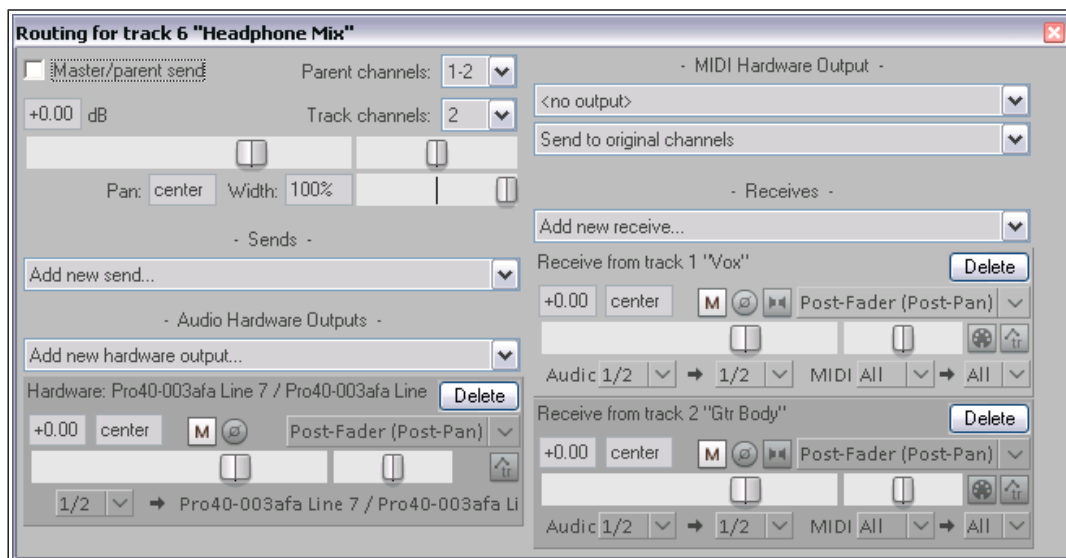

6. You can now use the Pan and Volume faders for your receives, together with the Mute buttons, to control your headphone mix.

5.12 Displaying Grid Lines

REAPER lets you determine whether or not to show grid lines in your projects. If you choose to show them, you have a number of options to determine how they are displayed. In this section we will look at three examples of how you might choose to use grid lines if you wish.

The display of grid lines is toggled on and off using the **Grid** button on the toolbar, or the **Options, Snap/grid, Show grid** command, or the keyboard shortcut **Alt G**.

Grid line settings are accessed by right-clicking on the **Grid** button, or choosing the **Options, Snap/grid, Snap/grid settings** command or by the keyboard shortcut **Alt L**. The examples below illustrate the effects of various permutations of grid setting options. These include options for the display of **marker lines**. Markers will be explained in Chapter 9.

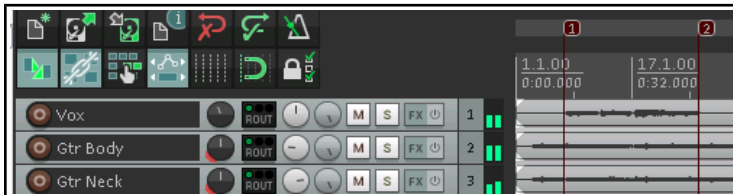
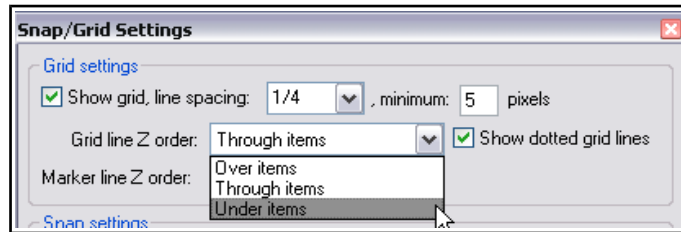

Show grid disabled.

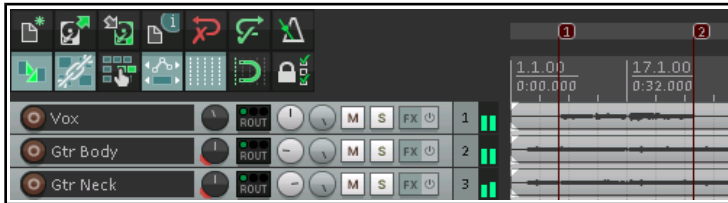

Show grid enabled.

Spacing 1 beat, minimum 10 pixels.
Grid line thru items, Marker line over items.
Dotted grid lines selected.

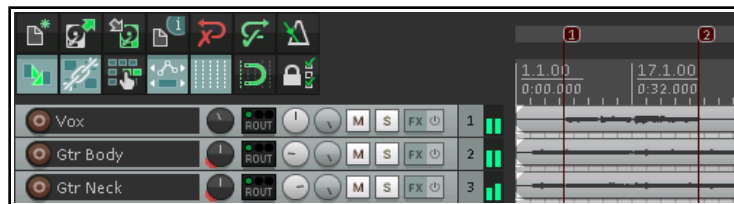

Show grid enabled.

Spacing 1 beat, minimum 5 pixels.
Grid line under items, Marker line over items.
Dotted grid lines not selected.

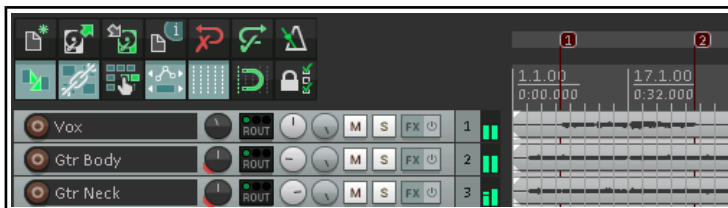

Show grid enabled.

Spacing 1 beat, minimum 5 pixels.
Grid line over items, Marker line under items.
Dotted grid lines not selected.

Note that you also have an option to set the grid line spacing to **frame** rather than to a fraction of a beat. This can be useful when working with video media. (Frame rate is set in Project Settings, see Chapter 2).

Later in this guide (Chapters 6 and 7), you will be shown how to use grid settings to automatically snap various objects and items into position.

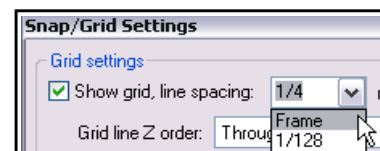

5.13 Understanding Sends, Buses, Submixes and Folders

You have already seen that each of the tracks in your projects has its audio output routed by default to the master, and that from here the audio signal is directed to your preferred output device or devices, such as speakers or headphones. The signal flow that occurs here within REAPER can be represented by the first diagram on the right, which shows a simple project with just three tracks.

In Chapter 2 of this User Guide, you were shown how to use a track as an effects bus, for example to add the same reverb effect to a number of tracks. The signal flow for this arrangement can be represented by the second of the two flow charts (below right).

The sends that you create for each track carry a signal to the Bus track, which applies the effect, and then sends the processed (wet) signal on to the Master. At the same time, so long as the **Send Master/Parent** option remains enabled, the dry signal for each track is also sent directly to the master. Here it is finally mixed together with the "wet" signal from the bus before being directed to your speakers and/or headphones.

These two example models use routing arrangements that you would expect to find in probably any DAW program. However, we are now about to enter territory where REAPER may be substantially different from other software that you may have used before. This relates to how you can create and use submixes.

With most programs, to create a submix (perhaps for your various drum tracks or vocal harmonies) you will need to create a bus, add sends from each track that is to be included in the submix, and then disable the direct sends to the master from each of these tracks.

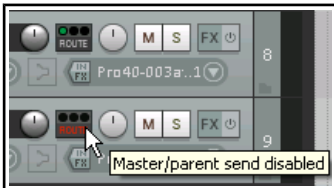

You can use this method in REAPER. Holding the **Alt** key while you click on a track's **ROUTE** button will toggle on and off the direct send to the master. If a track's output to the master is enabled the first of the green "lights" on the ROUTE button is turned on. If disabled, it is turned off. This distinction is shown on the left. In the first (top) track, the output

from the track to the master is enabled. In the second (bottom) track, it has been disabled. If there are no other sends or receives on that track, the word ROUTE is then shown in red.

However, a smarter and potentially more powerful way of creating a submix is to use folders (sometimes called track folders). We'll look at how this is done shortly, but first let's get our heads around the concept.

A folder track is created initially in the same way as any other track. You then tell REAPER to treat this as a folder track - and essentially that's it. You now have your submix (as shown here on the right). Direct output to the master from the individual "child" tracks within the folder is automatically disabled.

Instead, they are passed thru the folder. Note that you should not manually disable the master/parent send for child tracks within a folder, or their output will no longer go to the folder (the master track).

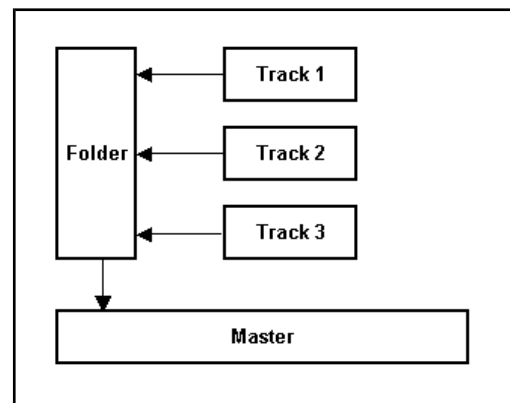
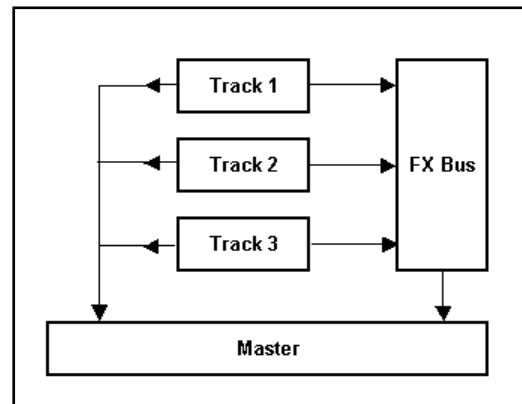
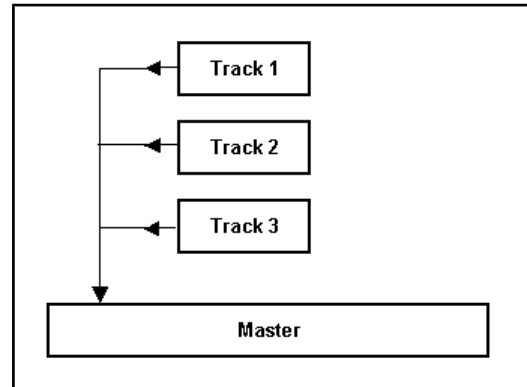

Up and Running: A REAPER User Guide v 5.24

Anything that you do to the folder will be done to the entire submix. For example, if you adjust the volume up or down, the volume of the submix will be adjusted up or down. If you add an effect such as a compressor to the folder then that effect will be applied to the submix.

Before we see exactly how a folder and its child tracks are set up, there's one more scenario to consider. Even when you have a folder which contains a submix of other tracks, you can still use buses for the folder itself or for individual tracks inside the folder

(see right). In this case our folder (submix) still consists of the same three tracks as before. In addition, however, a send has been created from the folder to an FX bus, perhaps to add reverb to the submix. We'll see an example of this soon.

There are three types of send – **Post-Fader (Post Pan)**, **Pre-Fader (Post FX)** and **Pre FX**. These are explained in Chapter 17 and illustrated by the flow charts at the end of Chapter 6. For the time being, accept the default option, Post-Fader (Post Pan).

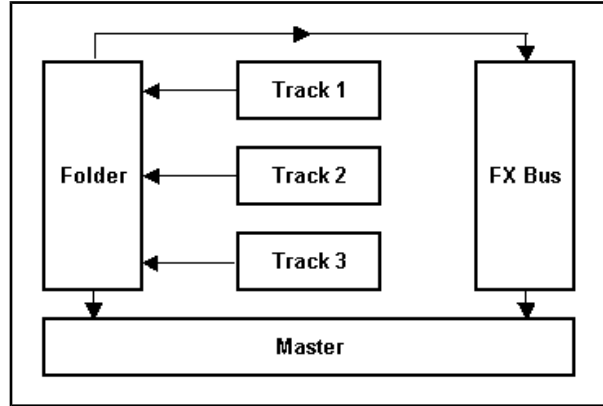

5.14 Track Folder Essentials

When a number of tracks are collected within a folder, you will probably want to use both the individual track controls and the folder controls. For example, you can use the **Volume** controls for individual tracks within a folder to set the volume levels for the different tracks relative to each other. You can then use the Volume control for the folder itself to control the overall combined volume level of the tracks in that folder.

Another example is that the **Mute** and **Solo** controls for the folder will act on the folder as a whole. However, you do still have the option of using each track's individual Mute and Solo controls.

The example illustrated (right) shows a folder called **Instruments** that contains three individual tracks. The faint peaks that you see in the folder's lane in arrange view represent the combined contents of the folder's child tracks. This can be disabled on your Preferences, Appearance, Peaks/waveforms page. Identify the little icons that you can see below the track number of each item in the track control panel. These are used to determine a track's folder status. Ordinarily, this can be one of four states:



- ◆ An ordinary top level track (the default). The icon is displayed as a faint image of a folder. Hover the mouse over this image and it changes to a + sign.
- ◆ A folder track. This is displayed as in the Instruments track above, as a stronger image of a folder. Hover the mouse over this image and it changes to an X (see right).
- ◆ A child track within a folder. The track is nested and the icon is displayed as a faint image of a folder. Hover the mouse over this image and it changes to a + (see below right)
- ◆ The last track in a folder. A folder icon is shown and the track is nested. Hover over this icon and it displays a down pointing arrow.



You can click on this icon to set a track's status. Let's work thru an example.

1. Open the file **All Through the Night.RPP** and save it as **All Through the Night Folder.RPP**
2. Make sure the Vox track is track 1, Gtr Body track 2, Gtr Neck track 3 and Bouzouki track 4.
3. Press **Alt Enter** to display project settings. Select **Stereo Pan** as project pan mode. A width rotary control is now added to every track.

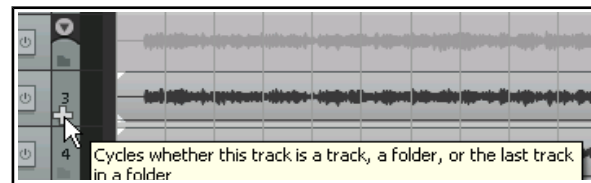

5 - Project Arrangement Basics

4. Select track 1. Press **Ctrl T** to insert a new track immediately underneath this track. This becomes track number 2. Name this track **Instruments**.
5. Click once on the folder button for this track. It becomes a folder and the tracks below it are indented.
6. We want the bouzouki to be the last track in the folder. Click twice on that track to set this. Adjust the panning of the three child tracks as you wish.
7. To illustrate a point, select the Bouzouki track and press **Ctrl T**. A new track is added outside the folder.
8. Name this track **Reverb** and insert **ReaVerbate** into its FX chain. Drag and drop in turn from the ROUTING button of the Vox track and the ROUTING button of the Instruments folder to this Reverb track. This will create two sends.
9. Lower the Reverb track volume to about -10.0 db (see right) and save the file.
10. Play the file. Experiment with folder controls. For example, mute the folder and you mute all instruments. Solo it and you solo all instruments. Adjust the volume and the overall volume of the instrument submix changes.
11. Use the width control on the folder track to bring the different instrument tracks closer together or further apart. Use the pan control to move the whole instrument mix further left or right.



To restore a folder as a normal track, click on the folder control icon as many or as few times as are required to cycle thru the various options until you see the one that you want.

5.14.1 Drag and Drop Folder Management

Another way of creating folders is by dragging and dropping. You identify which track is to be the folder, which are to be its children, then select and drag and drop the children into the folder. When you know what you are doing, this method is probably quicker, but it can be tricky at first. This process is illustrated below.

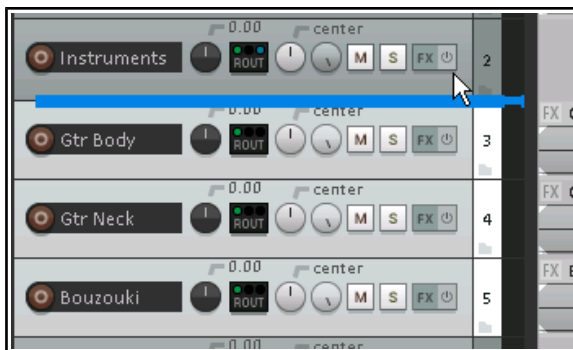
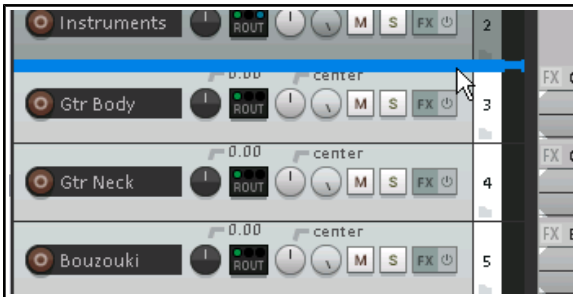

Here's the same project file as before (except that this time the Reverb track has already been added).

Three tracks have been selected and we have begun to drag and drop them up. Notice that the thick horizontal bar shown above the first of these tracks occupies the whole width of the track control panel.

Carefully and slowly drag them a little higher and you will notice that the horizontal bar is now indented slightly.

Now release the mouse and you will see the three tracks have been placed as child tracks within a newly created Instruments folder (see below).

Up and Running: A REAPER User Guide v 5.24

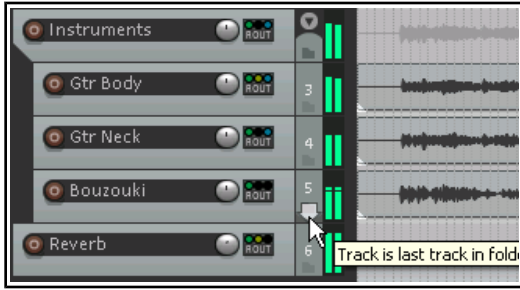

If you hover the mouse over the folder icon for the Bouzouki track you should see confirmation that it is the last track in the folder.

The drag and drop method can also be used to add tracks into an existing folder, and/or to remove them. However, the technique may take a little getting used to.

Experiment with this now if you wish.

Notice the small down pointing arrow just above the track number of the folder track (in this case Track2).



This can be used to toggle the display of child tracks in the folder between normal (as shown above left), minimized and collapsed (as shown below left).

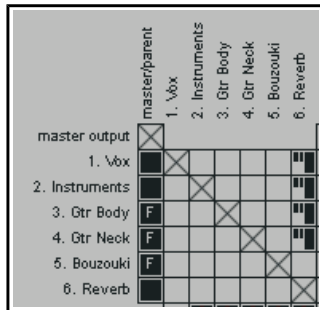

Notice that when you view the routing matrix, child tracks of folders are indicated by the letter F being displayed in the master/parent column (see left). The parent destination is also shown in the tooltips (see below).

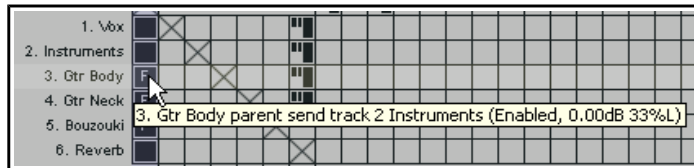

The parent track is also shown in the track routing window (see right).

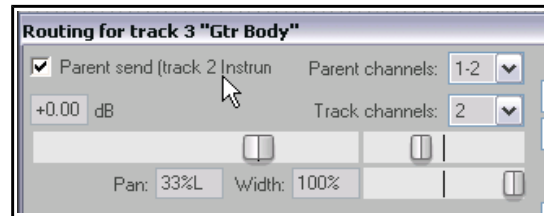

5.14.2 Nested Folders

REAPER allows you to nest folders within folders, to as many levels as you like. This feature is probably more suited to relatively experienced DAW users than it is to newcomers.

To create a nested folder, first create an empty track within an existing top level folder, then use the folder control icon to make that track into a folder. Because the track is itself contained within an existing top level folder, it will automatically be made into a second level folder. The project shown here is an example of this. Notice that:

- There is a top level folder called Instruments which holds two sub-folders (Drum Kit and Guitars).
- The two second level folders which are sub-folders of the Instruments folder each contain child tracks of their own.
- There is another top level folder (Reverbs) which itself contains two reverb busses.

Any action taken on a folder will effect its entire contents. For example, if in this case you were to mute the Instruments folder, then you would automatically also mute the contents of the Acoustic Guitar and Other Instruments folders.



REAPER does not limit you two levels of folders. You can have more if you like. Be warned, however, that if you do, life can get complicated!

5.15 Track and Track Parameter Grouping

Note: As well as conventional grouping, REAPER supports VCA (Voltage Controlled Amplifier) grouping. To help avoid confusion, VCA grouping will be considered as a separate topic later in this chapter.

The topic of track and parameter grouping is a huge one with an extraordinary range of options designed to help you especially in your mixing and arranging. It is based upon this principle. *You can define group relationships between different tracks and their controls so as to ensure that when you make a change to one track in the group, changes are also made to the other tracks in the group.*

The nature of these relationships can vary from being quite simple to rather complex, and everything in between. Everybody will have their own different ways in which REAPER's track grouping feature can be helpful. Let's look at some possible examples. These examples have been selected primarily for learning purposes. You might or might not find the actual examples themselves to be useful for you.

- You might have two tracks that you wish to keep at a constant volume relative to each other. In this case, you could ensure that whenever one is faded up or down then so is the other.
- You might have two tracks that need to be panned opposite each other. In this case, you can ensure that when one is panned in one direction, the other is automatically panned in the other direction.
- You might have two or more tracks that you wish to treat as a group so that they are always soloed or muted together.

In a moment, we'll work thru some examples. There are two main ways to create and manage your groups. This can be done either using the **Track Control Panel** or the **Track Grouping Matrix**. Here is an overview of both methods.

Method 1 uses the Grouping dialog box (shown right), which can be accessed from the Track Control Panel or the Mixer Control Panel. The method is as follows:

- ◆ In the TCP or MCP, select the tracks whose parameters you wish to group.
- ◆ Right-click over any track number in the group and choose **Track grouping parameters** from the context menu (or press **Shift G**).
- ◆ When the Grouping dialog box is displayed (see left) specify those parameters that you want to group, then click on **Close**.
- ◆ Make sure that the option **Track grouping enabled** on the TCP or MCP menu is selected (ticked).

You can use this same method later to make changes to your grouped parameter definitions.

This interface might appear a little overwhelming at first. For this reason, it may be easier, especially at first, to use the second method. Method 2 uses the **Track Grouping Matrix**. This is illustrated overleaf.

The grouping matrix, which can be docked, can be used to manage up to 32 different groups. To display this, choose the **View** command, then **Track Grouping Matrix**, or press **Ctrl Alt G**. The picture that follows shows just two groups on display. We can create a special project file for our examples. You can then group any selection of tracks that you like: in this example, we will be working with two of three tracks enclosed within a track folder. Note that you do not need to place tracks in a folder in order to be able to group them.

5.15.1 Basic Track Grouping

Example

In the examples that follow, the optional **Width** control is shown, but not included in any groups. Whether or not this is visible will depend on your choice of track layout. This is explained in Chapters 10 and 11.

1. Open the file **All Through The Night.RPP** and immediately save it as **All Through The Night GROUPS.RPP**

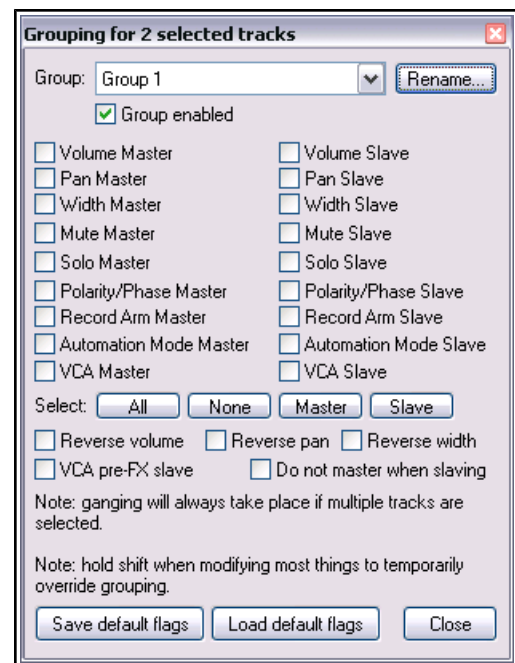

Up and Running: A REAPER User Guide v 5.24

- Select Track 1 (Vox) and press **Ctrl T** to create a new track immediately below it. Name the new track **Instruments**. Using the techniques explained earlier in this chapter, make this track into a folder. Enclose in the folder the two guitar tracks and the bouzouki track. Make the bouzouki the last track in the folder. Save this file. First, you need to make sure that the track grouping is enabled, Choose the **Track** command from the main menu. If **Track grouping enabled** (near the bottom) is not ticked, click on this command to select it. If it is already ticked, just click on the REAPER title bar.
- Choose the **View, Track Grouping Matrix** command to display the Grouping Matrix.

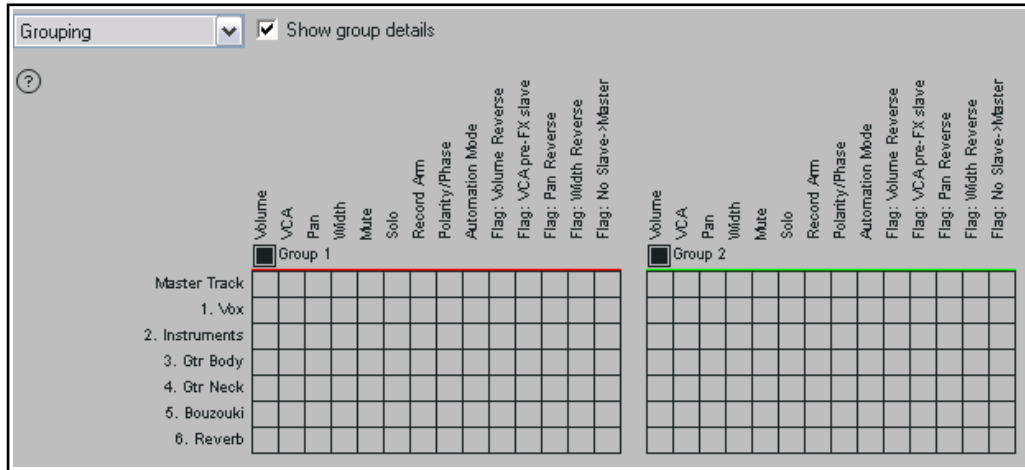

- Pan one guitar track about 50% left, and the other 50% right.
- In Group 1 on the Grouping Matrix, click in the cells representing **Gtr Body** and **Gtr Neck** in the **Volume** column.
- Click in the cells for **Gtr Body** and **Gtr Neck** in the **Pan** column. In this column, click also in the **Pan Reverse** cell for one of the guitars, as shown (right).
- The volume controls for these two tracks are grouped so that when you adjust the volume for either track, both volume faders will move together in the same direction.
- Perhaps more interesting, when you now move the pan control left or right for either of these tracks, the other track's pan fader will move in the opposite direction.
- Save the file.
- Now click in the cells for the two guitar tracks in the **mute** and **solo** columns and again save the file. The solo and mute controls for these two tracks are also linked together. Try them out!
- To temporarily override the grouping, hold **Shift** while you adjust the volume of one of the guitar tracks. Notice only that one fader is adjusted. You can use **Shift** to temporarily override any grouped track parameters.
- To temporarily disable the group altogether, click where shown (right) on the Group 1 enable/disable toggle control. You will now find that all group controls for this group are disabled.
- Click in this same cell again to again enable the group. Save the file.

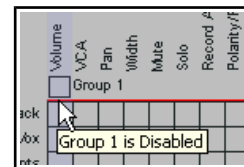
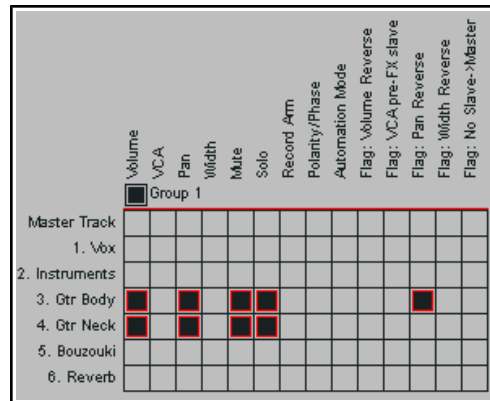

The table that follows on the next page summarizes what you might have discovered about grouping track control parameters from this exercise.

Note: A item's group control status can be master only (M), slave only (S) or master/slave (the default). In this exercise, all grouping has been of the default type, master/slave. We'll get to the other two options shortly.

5.15.2 Track Grouping Matrix Basic Controls

In order to do this ...	Using the Track Grouping Matrix
Define the tracks in a new group	Display the Track Grouping Matrix. Select at least one parameter (such as Pan) for each track in the group.
Adjust all linked faders for a group	In Mixer or Track Arrange view, adjust the fader for any one track in the group.
Adjust the fader for only one track in a group containing linked faders	In Mixer or Track Arrange view, hold Shift while adjusting the single fader.
Define a pan or volume relationship as reverse for a track within a group	In the track row, click on the intersection cell for Pan Reverse or Volume Reverse .
Change an existing toggle parameter relationship (such as Solo, Mute or Record Arm) into a reverse one	In Mixer view, hold Shift while clicking on the appropriate button (such as Solo or Mute) for the individual track. Use Shift again to restore the positive relationship.
Link more parameters for tracks in an existing group	Click on the intersection cells where the required parameter column meets the track rows.
Add another track to an existing group	Click on intersection cell where the required parameter column meets the row for the track that is being added.
Remove a track from an existing group	Click once, twice or three times on the appropriate intersection cell until it shows blank. If more than one parameter is linked, do this for each parameter.
Enable/Disable group	Click in the group's Enable/Disable box.
Select all tracks in a group	Click on the group name.
Ensure automation mode of slave tracks automatically follows that of master	Use the Automation Mode column of for tracks in the group.
Fine tune behavior of groups which share common tracks.	Use the Flag: No Slave-Master settings to ensure, for example, that a track which is a master in group 1 and a slave in group 2 will not act as a master in group 1 when being slaved in group 2.

5.15.3 Track Grouping Indicators

By default, colored ribbons are used on the Track Control Panel to identify grouped track parameters (see right).

Under **Options, Preferences, Appearance** there is a sub-section **Track Control Panels** whose contents includes the option to instead use lines on the edges, or not to use any indicator at all.



5.15.4 Master and Slave Group Relationships

Each parameter that is included in a grouped relationship can take one of three states – Master/Slave (the default), Master only, or Slave only. The different ways in which this affects that parameter's behavior are:

- ◆ A Master/Slave item can control other Master/Slave and Slave only items, but not Master only items. It can itself be controlled by other Master/Slave and Master only items.
- ◆ A Master only item can control other Master/Slave and Slave only items, but not Master only items. It cannot be controlled by any other item
- ◆ A Slave only item cannot control any other item, but can itself be controlled by Master/Slave items and Master only items.

Up and Running: A REAPER User Guide v 5.24

Don't worry, this isn't as complicated as it sounds. To make sense of it all, let's work thru a couple of examples. In the previous exercise, all items within our group had Master/Slave status. This meant, for example, that when you adjusted the panning or the volume on either of the two guitar tracks, the equivalent parameter on the other guitar track would move according to the defined relationship. This happened regardless of which of the two tracks you used to make the adjustment. Let's now look at some different scenarios.

Example

1. Open the file **All Through The Night GROUPS.RPP** that you made in the last example. We are going to add the Bouzouki volume control to this group as a slave only.
2. Make sure the grouping matrix is displayed. Click in the Bouzouki row of the Volume column for group 1 to add this to your group. It is assigned the default status of Master/Slave.
3. Click in the same cell again. The display changes to **M**. It now has master only status. Click again, and the display will change to **S** for slave only status (see right).
4. Observe this track in the track control or mixer panel. You will see only one colored ribbon on the track's volume control (instead of two). In the TCP (mixer control panel) this will be at the bottom. This indicates its slave status.
5. Play the song. Adjust the volume for either of the guitar tracks, first up, then down. Observe that because of its slave status the volume of the bouzouki track will be adjusted with it.
6. Now adjust the volume of the bouzouki track, first up then down. Because of its slave only status, it cannot control any other track. The volume faders of the guitar tracks will not move as you change the volume of the bouzouki track.
7. Now, for learning purposes, let's change the bouzouki volume status to master only. Click on that cell several times to cycle thru the options. Stop when it displays **M**.
8. This is the opposite of what happened at step 3. First, the colored ribbon indicator for this item is now shown only on the left instead of the right. This confirms its master only status (see right).
9. Play the song. If you adjust the volume fader on the bouzouki track, the faders on the two guitar tracks will also move. However, if you adjust the volume of either guitar track, the other guitar track will also move, but the bouzouki fader will not.
10. Save the file when you have finished.

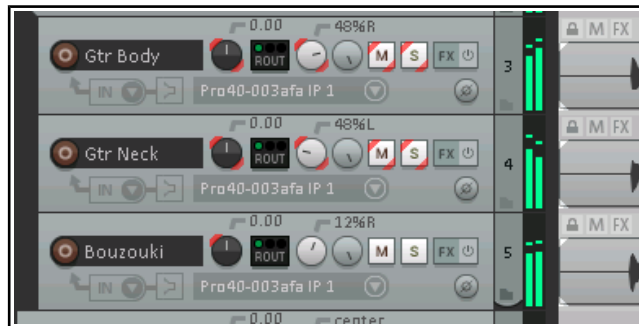
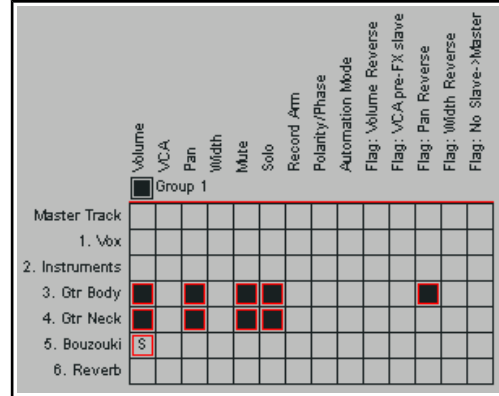

5.15.5 Track Grouping Window

Earlier we introduced the track grouping window, and said that this interface offered a different method of working with track grouping and with grouped track parameters. Let's now see how.

The Grouping window displays all group information about the various parameters for any selected track or selection of tracks. Most commonly (and most usefully) it makes sense to use it with individual tracks, one track at a time. Again, this will be more readily understood if you work thru an example.

Example

1. With the project file **All Through The Night GROUPS.RPP** open, select the **Gtr Body** track in the track control panel.
2. Either right-click over the track number and choose **Track Grouping Parameters ...** from the context menu, or press **Shift G**.
3. This causes the Grouping window for the selected track to be displayed (see below left).

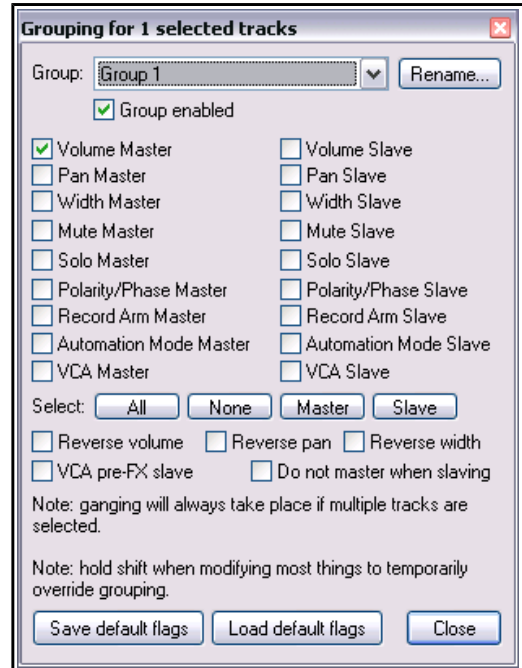
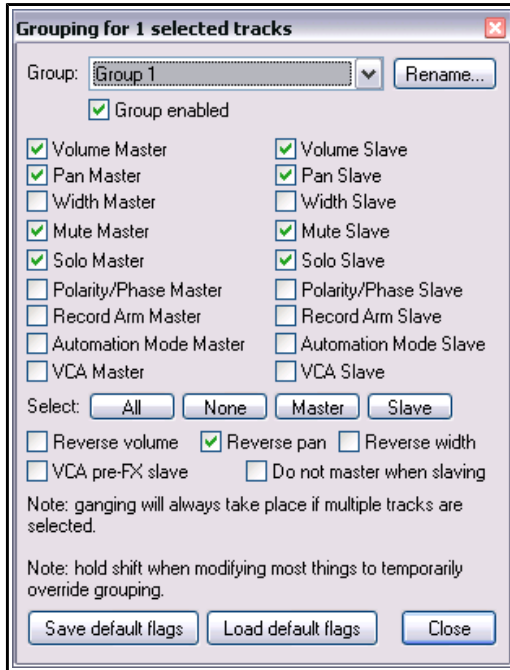

- In the TCP, select the Bouzouki track. The display in the Grouping window changes (above right), to show the currently grouped parameters for the bouzouki – in this case, just the master control on the volume track.
- In this dialog box, click and select **Mute Master**, **Solo Master**, **Mute Slave** and **Solo Slave**. These group parameters are now also selected for this track. This is confirmed by the display in the track grouping matrix.
- One more thing we can do here is to rename the group. Click on the **Rename** button, type **Instruments** and press **Enter**.
- Close the dialog box. Observe the track grouping matrix. Save this file.

You can define up to 32 groups in a project file. In the example below, a second group has been added, to help when adjusting the balance between the volume of the vocal track and the instrument mix.

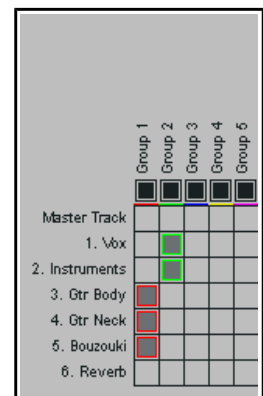
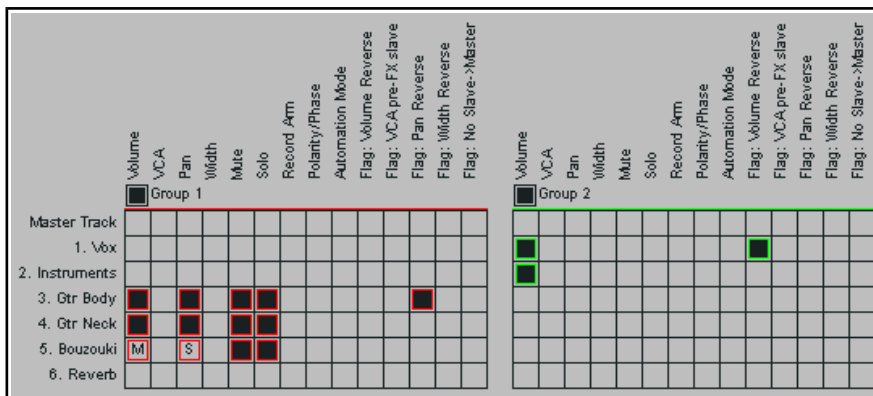
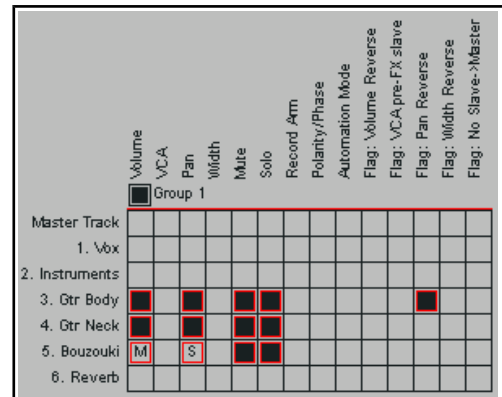

Note: You can right-click over the matrix empty background area for a menu which allows you to toggle on (above left) or off (above right) the option to **Show individual group details**.

Up and Running: A REAPER User Guide v 5.24

5.15.6 Track Grouping Window Basic Controls

In order to do this ...	Using the Track Control Panel
Define the tracks in a new group	Select the tracks in the Track Control Panel, press Shift G then select at least one parameter.
Name a group	Press Shift G , select the required group number and click on Rename .
Adjust all linked faders for a group	Adjust the fader for any one track in the group.
Adjust the fader for only one track in a group containing linked faders	Hold Shift while adjusting the single fader.
Define a pan or volume relationship as reverse for a track within a group	Select the track in the Track Control Panel and press Shift G . Click on Reverse Volume or Reverse Pan as required.
Change an existing toggle parameter relationship (such as Solo, Mute or Record Arm) into a reverse one	Hold Shift while clicking on the appropriate button (such as Solo or Mute) for the individual track.
Link more parameters for tracks in an existing group	Open the Grouping dialog box for the group and select the required parameters.
Reset a track's volume, pan or width to its default value and adjust settings for other group members accordingly	Double-click on the volume, pan or width value displayed in the track panel.
Add another track to an existing group	Select the track in the Track Control Panel and press Shift G . Display the drop down group list and select the required group. Select the required parameters.
Remove a track from an existing group	Select the track in the Track Control Panel and press Shift G Unselect all selected items except Group enabled
Enable/Disable group	Press Shift G , select the group from the drop down list then click in the Group enabled box.

Tip: When you are playing back a song, in the course of editing you may from time to time wish to reset your VU Peaks without needing to stop and restart playback. To clear one peak, simply click on the peak number shown at the right hand end of the VU meter in the TCP or top of the VU in the MCP. To clear all peaks, hold down the **Control** key while you do this.

5.16 VU Meters on Multichannel Tracks

Where a track has more than two channels you have the option of showing the output of all channels on the track's VU meters in the TCP and Mixer.

This feature is toggled on and off for any track or track selection by right-clicking over the track panel area (for example, on the track number) and enabling or disabling **Multichannel track metering** on the context menu.

Shown right is a track with audio on four channels, as displayed in the Mixer using the default theme and layout.



5.17 VCA Grouping

The origins of VCAs (Voltage Controlled Amplifiers) predate digital audio. Today, REAPER's contemporary implementation of VCAs opens up interesting mixing opportunities for you.

By way of analogy, VCAs in REAPER are a form of track grouping which allows tracks to be slaved within a group to a single track master. VCA slave tracks will have their volume dBs added to that of the VCA master track: thus, with VCA grouping the process is additive. With conventional grouping, however (such as that explained in section 5.15) nothing is added, the tracks are simply linked.

VCA groups can be set up and managed using the same grouping matrix that was introduced earlier in this chapter. With experience and experimentation you will come to learn that VCA grouping can be a very useful mixing tool. To begin with, however, we will keep to simple examples, designed primarily to help you understand the concept and how it is applied. The basic procedure for creating a VCA group is:

1. Add a new track to your project and give it a suitable name, such as VCA Control. Ordinarily, this track should contain no media items.
2. Display the grouping matrix and select a currently unused group. Optionally, you may give this group a name.
3. Set the VCA status in this group for your VCA Control track to M (for master).
4. Set the VCA status in this group for any tracks that you want it to control to S (for Slave).

You might find the example that follows easier if you understand the basic functionality of the grouping matrix, as explained in section 5.15.

Example

1. Open the file **All Through The Night.RPP** and save it as **All Through The Night VCA.RPP**.
2. Pan the first of the guitar tracks about 35% left and the other about 35% right.
3. Add a new track (Track 5) and name it **VCA Control**.
4. Display the grouping matrix (**Ctrl Alt G**). Make sure that the other tracks are in the same order as shown here in the matrix (below right).
5. In the grouping matrix, right-click over the text **Group 1** to open the Grouping dialog box (above). Click the **Rename** button, then type **VCA**, then click on **OK**, then close the dialog box.
6. Set up this group as shown (right), so that track 5 is your VCA master track and tracks 2, 3 and 4 are VCA slave tracks. In order to do this, click once on the appropriate cell for each of these tracks to add it to the group, then click once more to make it master (M) and (for tracks 2, 3 and 4) once again to change this to slave (S).
7. Play the song. As you raise the volume fader on the VCA control track, the three instrument tracks will each become louder. As you turn down the volume on track 5, the instruments will become quieter.
8. Notice that the VU meter levels on the slave instrument tracks will change during this. The adjusted volume of these tracks (added to that of any audio produced by any items that might be in VCA control track itself) is sent to the master. Thus, the master's VU meter levels will change as the VCA control track fader is adjusted.
9. In addition, you are free, if you wish, to adjust the volume of any of the individual instrument tracks without affecting any other tracks in the group. Save the file.

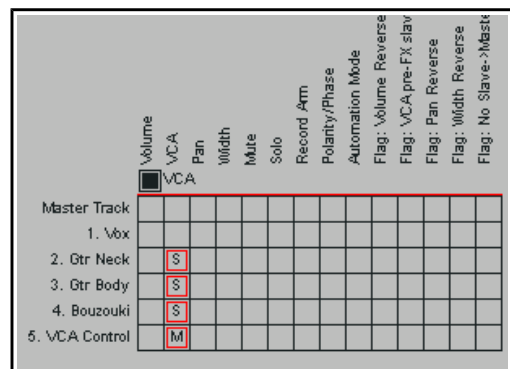
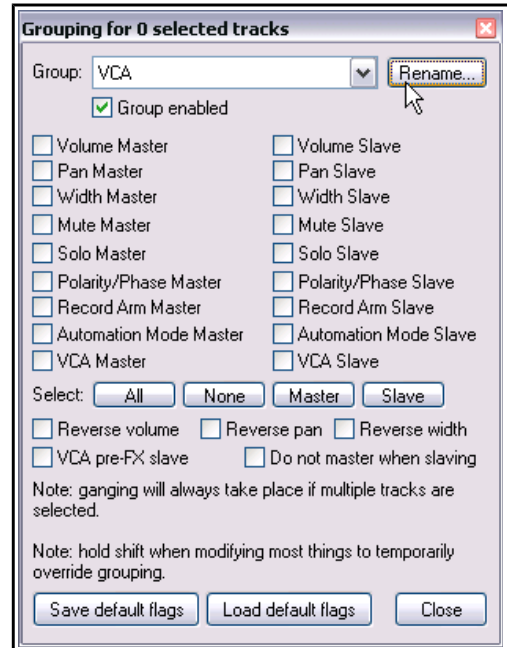

Up and Running: A REAPER User Guide v 5.24

10. Now let's try something different. Make sure that the pan law for all tracks is set to **Stereo balance/mono pan**. This is done by right clicking over the track's pan control and selecting from the pan law drop down list (right).

11. Click on the Bouzouki/VCA matrix cell to remove it from the group.

12. Now play the song again. As you do so, adjust the pan setting on the VCA control track. You will find that the panning of the three instrument tracks will each be adjusted accordingly. Save the file.

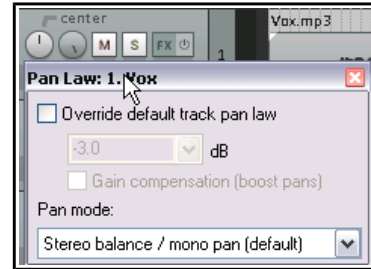

VCA Grouping Parameters

This table summarizes the VCA grouping matrix options and parameters:

Parameter	Comment
Volume	Adjust the volume fader on the VCA master to adjust the volume of all slave tracks in the VCA group. Note that the slave track faders themselves will not be moved.
Pan	Provided either Stereo balance/mono pan or Stereo pan has been selected as the pan law, changing the panning on the VCA master will cause the panning of all slave tracks in the group to be changed. The pan faders on the slave tracks, however will not be moved.
Pre FX Slave	If the grouping matrix option Flag: VCA pre-FX slave is selected for any VCA slave track, then the signal volume will be adjusted before it is fed into the that track's FX chain.
Automation	Volume, pan and width changes on slave tracks can be automated by adding envelopes to the VCA control track. The envelopes will be applied to all slave tracks in the group. Slave tracks may also have their own automation envelopes. Chapter 18 includes more about envelopes.
Mute	A mute envelope can be added to the VCA master. This envelope will be applied to all VCA slave tracks in the group. Automation envelopes are explained in Chapter 18.

Note: Defining a track as a VCA master causes that track's volume and pan faders to control volume and panning on all of its slave tracks. Keep in mind that a VCA control track is *not* a track folder or submix. No audio passes thru a VCA master/control track. Thus, for example, it would make no sense to add any audio FX directly to a VCA control track.

Further Examples of VCA Grouping Models

Here are some more examples of situations in which VCA grouping can be helpful. Doubtless you will in time find further and perhaps more complex applications of your own.

VCA with Automation Envelopes

You will need to understand something about automation envelopes if you are to understand this section. Automation envelopes are explained in Chapter 18.

Problems can arise when using automation envelopes with conventional groups. For example, a volume or pan envelope on a master track in a conventional group will, on playback, adjust the volume or pan settings on that one track only, not on its slaves.

With VCA grouping, however, an envelope on a VCA control track will be applied to the summed total of its slave tracks. Moreover, you can have separate automation envelopes on both the VCA master and any of the slave tracks within the group. Shown here is the same project as in the previous example, with the same groups as before, and with volume envelopes added to the VCA control track and one of the slave tracks (Bouzouki). The summed levels of both slave and master envelopes will, on playback, be sent to the master.



Actions to Manage VCA Envelopes

Two actions are available which add extra functionality to VCA envelopes. These are **Envelope: apply all VCAs from selected tracks to grouped tracks and reset volume/pan/mute** and **Envelope: apply all VCAs to selected tracks and remove from VCA groups**. Actions are explained in Chapter 15, but, in short, you can assign your own keyboard shortcuts to these actions, and/or add them to REAPER's menus.

The effect of these actions is illustrated here.

Tracks 2 and 3 are slaved to track 4 in a VCA group. A volume envelope has been added to the VCA master track. This track is selected.

Running the action **Envelope: apply all VCAs from selected tracks to grouped tracks and reset volume/pan/mute** causes an identical envelope to be added to each of the group's slave tracks and to remove it from the master. This is shown on the illustration to the right. The VCA group settings remain intact.

Running the action **Envelope: apply all VCAs from selected tracks to grouped tracks and remove from VCA group** would also cause identical volume envelopes to be added to each of the slave tracks, but these tracks would be removed from the VCA group and the envelope on the VCA master track (in this example, track 4) would remain intact.

Note that if any of the VCA slave tracks already contain a volume envelope, then the values on the VCA master track envelope will be added to those already on the slave track envelope.

These actions can be applied to VCA master pan, width and/or mute envelopes as well as volume envelopes.

VCA with Overlapping Groups

Conventional grouping does not fully allow for overlapping group membership. For example, on the right tracks 1 to 3 volume faders are grouped as masters and slaves in one group, tracks 4 to 6 in a second group.

We might want to also group, say, volume faders on tracks 1 and 6 so that they and they alone could be moved together when required. VCA grouping makes this possible. We add a VCA control track (track 7) and set up a third group as shown below:

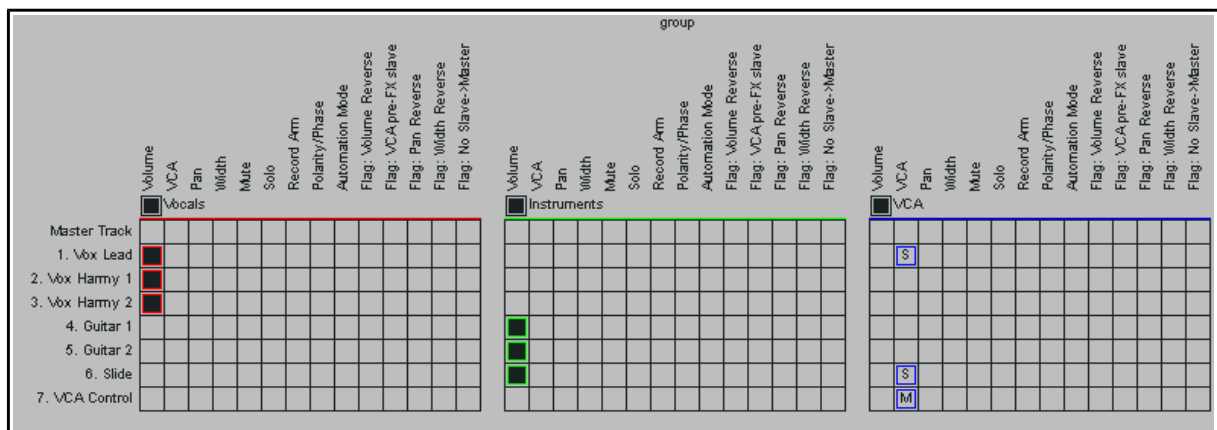

You would now find that you could adjust the volume of tracks 1 and 6 together by adjusting the volume fader on track 7, the VCA control track. No other track would be affected.

Up and Running: A REAPER User Guide v 5.24

VCA for Mix Control

This is a rather more complex and subtle example: newcomers to working with DAWs or REAPER might be best advised to stay away from this one until your knowledge and experience have grown a little!

This example uses VCA grouping in a project that includes folders as well as tracks. Three VCA groups have been set up, each with its own control track. The track layout shown on the right needs to be interpreted in conjunction with the grouping matrix shown below.

The groups are:

Group 1: Vocals VCA Control, track 14 (controls Lead Vocal track and Harmonies folder).

Group 2: DrumsBass VCA Control, track 15 (controls Drums folder and Bass track).

Group 3: Guitars VCA Control, track 16 (controls Guitars folder and the Bouzouki).

The use of the three VCA control tracks can assist in mixing, making it easier for us to achieve the required balance of sound between the vocals and various instruments in this mix.

The mix has effectively been divided into three groups. Individual track volumes and pan settings can still be adjusted in the usual way, but in addition the VCA controls can be used to adjust the balance between the three groups.

This setup is illustrated in the grouping matrix shown below.



Grouping Matrix		Group 1														Group 2														Group 3														
		group														group														group														
		Volume	VCA	Pan	Width	Mute	Solo	Record Arm	Polarity/Phase	Automation Mode	Flag: Volume Reverse	Flag: VCA-pre-FX slave	Flag: Pan Reverse	Flag: Width Reverse	Flag: No Slave->Master	Volume	VCA	Pan	Width	Mute	Solo	Record Arm	Polarity/Phase	Automation Mode	Flag: Volume Reverse	Flag: VCA-pre-FX slave	Flag: Pan Reverse	Flag: Width Reverse	Flag: No Slave->Master	Volume	VCA	Pan	Width	Mute	Solo	Record Arm	Polarity/Phase	Automation Mode	Flag: Volume Reverse	Flag: VCA-pre-FX slave	Flag: Pan Reverse	Flag: Width Reverse	Flag: No Slave->Master	
track	Master Track																																											
	1. Lead Vocal		S																																									
	2. Harmonies		S																																									
	3. Vbx Hmy 1																																											
	4. Vbx Hmy 2																																											
	5. Drums														S																													
	6. Kick																																											
	7. Snare																																											
	8. Tom																																											
	9. Bass															S																												
	10. Guitars																													S														
	11. Guitar SP																																											
	12. Guitar B3																																											
	13. Bouzouki																																											
	14. Reverb																																											
	15. Vocals VCA Control		M																																									
	16. DrumsBass VCA Ctrl															M																												
	17. Guitar VCA Control																																											

5.18 Audio Jogging and Scrubbing

Jogging and scrubbing are techniques originated in the days when all recording was done with magnetic tape. They help you to move within a project, or track, or group of tracks, to audition or locate a particular section. This is usually done in REAPER when your project is not playing, but you can over-ride this default setting.

To jog a portion of a song, simply position your mouse over the triangle that is located on the top of the edit cursor, as shown on the right. This causes the mouse pointer to change to a white hand. You can then click and drag in either direction. You'll probably find when jogging that you will want to zoom in quite closely on your project.



By default, holding down the **Ctrl** key while jogging will enable **Scrub** mode. In this mode, playback will be much slower. This can help when looking for very short glitches, for example when zoomed in close.

You can set your jog/scrub preferences in the **Audio, Playback** page of the **Options, Preferences** window, as shown below. Notice in particular that:

- You can limit the maximum jog/scrub rates (speed) to no more than normal playback speed. This makes it easier to identify the audio material when jogging or scrubbing.

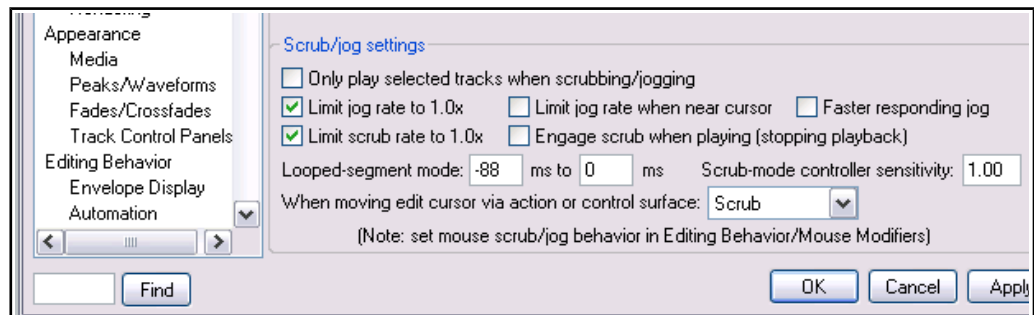

- You can also choose to be able to engage jog/scrub mode to over-ride normal playback.
- If you enable the **Only play selected tracks** option, then only those tracks currently selected will be heard when you apply jogging or scrubbing.

You can modify REAPER's jog/scrub behavior by opening the Preferences window and using the Mouse Modifiers page to define your own modifier keys for Edit cursor handle left drag behavior. The default assignments are shown on the right.

Looped segment mode can be used to audition a section of your material as a loop. For example, if in Playback preferences (above right) you specify a range of -1000 ms to 1000 ms, then holding **Alt** while you click and drag the edit cursor handle briefly left or right will jog a two second portion of audio over and over for as long as you hold down the mouse button.

You can also assign modifiers for jogging and/or scrubbing to your Arrange View middle mouse button drag behavior. For more information about assigning mouse modifier preferences see Chapter 22.

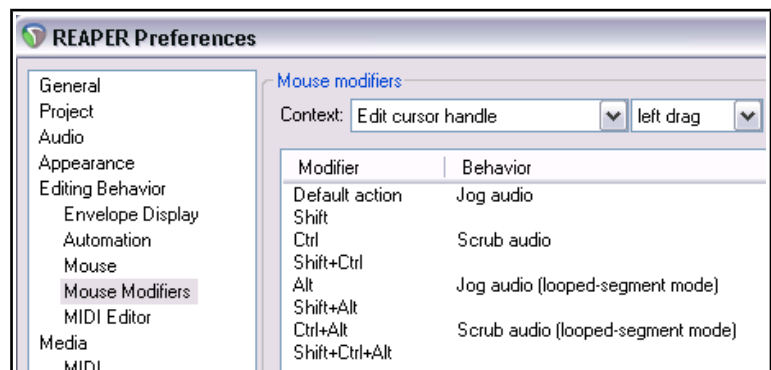

5.19 Default Toolbar Summary

REAPER's default toolbar is located near the top left corner of the screen. The various tools and their functions are introduced throughout this guide as and when they are required: in addition, you might find the summary diagram below helpful.

The actual appearance of the individual icons will depend on which color theme you are using. Themes can be selected using the command **Options, Themes** and then making your selection from the list available. Shown below are the icons used by the default themes for both REAPER 5 and REAPER 4.

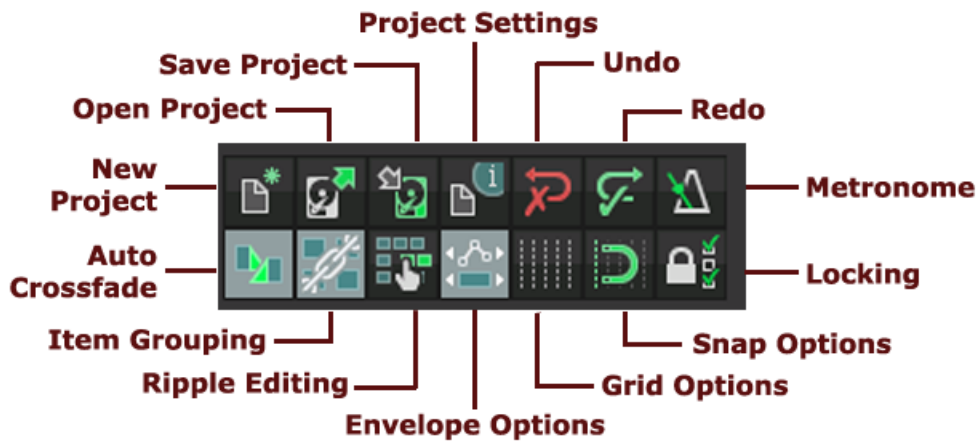

Toolbar keyboard shortcuts summary (equivalent to left click):

New Project: **Ctrl N**

Open Project: **Ctrl O**

Save Project: **Ctrl S**

Project Settings: **Alt Enter**

Undo: **Ctrl Z** to undo last action

Right click to view undo history

Redo: **Ctrl Shift Z** to redo last action

Right click to view undo history

Metronome: no default shortcut:

Left click to toggle on/off

Right click for settings

Auto Crossfade: **Alt X** to toggle on/off

Item Grouping: **Alt Shift G** to toggle on/off

Right click for menu

Ripple Editing: **Alt P** to toggle on/off

Right click for menu

Envelopes, move points with media items:

Left click to toggle on/off

Right click for menu

Grid Lines: **Alt G** to toggle on off

Right click for settings dialog

Snap: **Alt S** to toggle on/off

Right click for settings dialog

Locking: **L** to toggle on off

Right click for settings dialog

You can edit this toolbar, for example adding more tools for other commands and actions. You can also create additional toolbars of your own. This topic is covered in Chapter 15.

6 Managing Track FX

We have already covered the basic techniques involved in using effects (Direct X and VST) with REAPER tracks. We are now going to look at some of the options available to help manage and use your FX more effectively. We'll be looking in more detail at how you use some of the more important individual effects later (Chapter 16): in this section we're mainly concerned with the broader issues of managing and organising plug-ins.

6.1 Grouping FX in Folders

FX can be grouped in any way you wish. For example, if you use chorus, delay and reverb a lot, you might wish to create one folder called Chorus/ Delay and another called Reverb. Frequently used plug-ins can be copied into special groups. You can create as many folders as you wish, and the same plug-in can be placed in multiple folders. For example, you could place the Bootsy

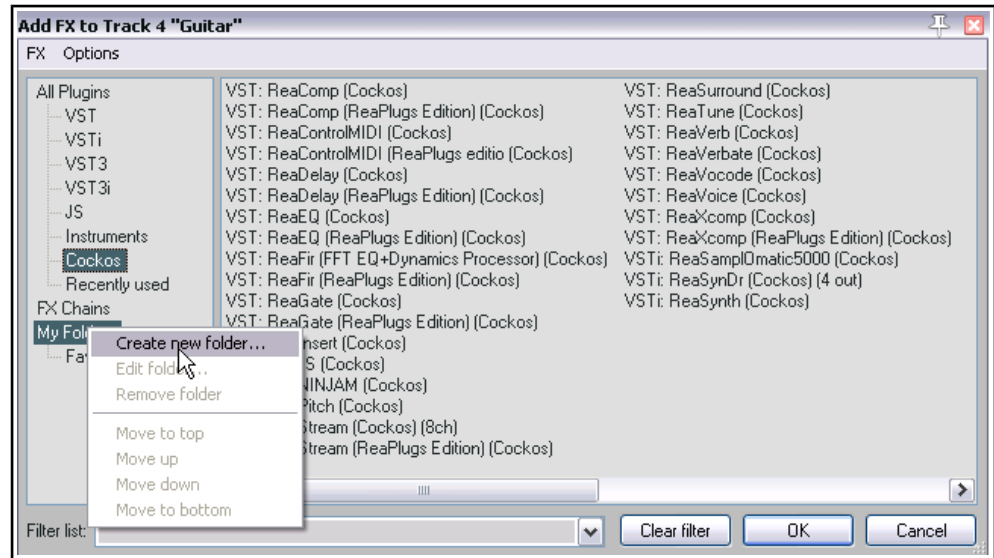

EpicVerb plug-in (with other plug-ins) both in a folder called Reverb and in a folder called Bootsy.

To create a FX group folder:

- ◆ Use the command **View, FX Browser** or the keyboard shortcut **Shift F** to open the FX browser window.
- ◆ Right click over the text **My Folders** where shown (see above) and choose **Create new folder**. Type a name, then press **Enter**.

To add FX to a folder:

- ◆ Select the category **All Plug-ins** in the left hand panel of the FX window. This will ensure that all FX are available to you.
- ◆ Drag and drop the required FX from the right hand panel to the folder where you want the FX to be listed. To drag multiple FX, use **Ctrl** with left mouse click to build up a selection, then drag them all together.

To create a smart folder:

If you enable the **Smart folder** option when creating a folder, all plug-ins whose names include any character strings that you define will automatically be displayed within that folder.

- ◆ Right-click over My Folders and choose **Create new folder**.
- ◆ Type a folder name, enable the **Smart folder** option and type a filter. In the example shown, we are creating a folder called **Dynamics** for all plug-ins with **comp** or **lim** in their names.
- ◆ Click on **OK**. The folder will be created and all plug-ins with comp or lim in their names will automatically be listed in it. You can still add more FX to this folder manually if you need to.

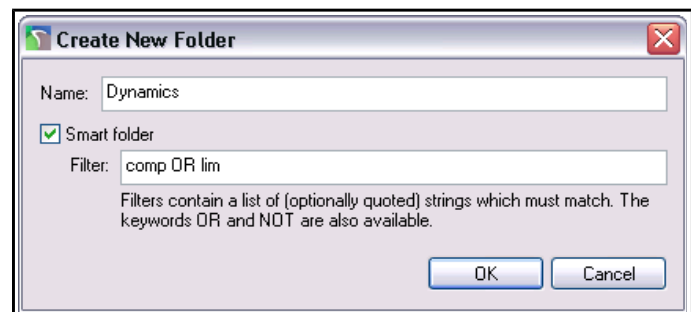

To change the order in which FX folders are displayed:

- ◆ Right click on the name of the folder to be moved.

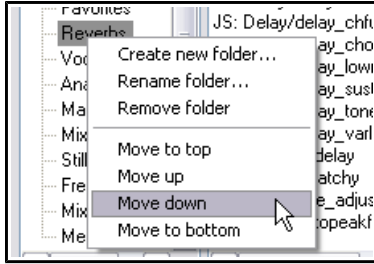

- ◆ From the context menu choose **Move to top**, **Move up**, **Move down**, or **Move to bottom**.

To display and select from a folder

- ◆ In the left panel of the FX window, click on the name of any FX group to display its contents in the larger right hand panel.
- ◆ Double click on any FX name within that group (listed in the right hand panel) to add it to the current track.

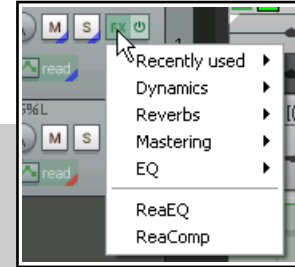

Tip: If you leave the **FX Browser** open, you can add any FX to any track simply dragging and dropping to the required track in the Track Control Panel (TCP) or Mixer Control Panel (MCP).

Tip: You can add FX from an existing folder to any track directly from the TCP or MCP. Right-click over the FX button and select first the folder and then the FX.

6.2 Backing Up FX Chains and FX Presets

FX Chains and plug-in presets can be backed up and restored using the export/import configuration buttons in REAPER's Preferences (General settings). See Chapter 22 for more information about importing and exporting configuration settings.

6.3 Filtering Track FX

By entering a text string in the **Filter list** text box in the bottom left corner of the **Add FX** window, you can display a list of those FX which match your criteria. Before doing this, you should select either **All Plugins** from the list of plugin folders, or any particular folder if you wish to restrict your search. In the example shown here, we have applied the text string *chorus* as a filter, in order to see what chorus plug-ins we have available.

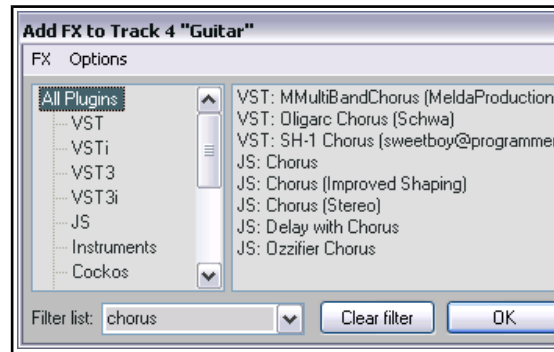

The filter list also supports Boolean search terms, e.g.:

comp OR lim finds and lists all compressor and limiter plug-ins.

eq (cockos OR melda) finds all Cockos and Melda EQ plug-ins.

blue cat NOT (flange OR phase) finds and lists all Blue Cat plug-ins except flangers and phasers. Note the spaces before and after the parentheses.

(chorus OR delay) NOT (DX: OR JS:) finds all chorus and delay effects except Direct X and JS.

The **Clear Filter** button can be used to remove the filter and restore all plug-ins to view. In REAPER's Preferences (Chapter 22) there is also an option to apply a global filter to all browser views.

You also have two options (on the **Options** menu – see below) which if enabled will ensure that your filters are automatically cleared for you. These are **Auto clear search field on folder change** and **Auto clear search field on close**. This latter option refers to closing the FX browser window, not closing REAPER.

REAPER will remember your previous filters. You can access it from the filter drop down list, by clicking on the down pointing arrow located on the edge right of the *Filter list* box.

6.4 FX Browser Options

The FX browser Options menu is shown here. In summary, the available commands are:

Auto-float new FX windows. If enabled, FX will be opened and displayed in a separate window of their own when they are added, rather than within the FX browser.

FX Plug-ins settings... This causes the **Options, Preferences, Plug-ins settings** page to be displayed (see Chapter 22).

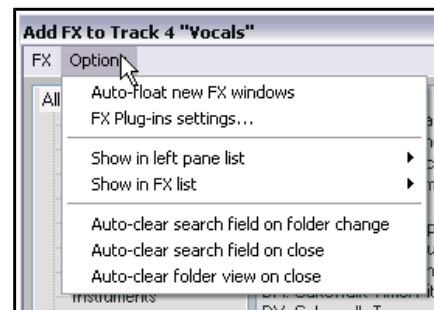

Show in left pane list.

This displays as a sub-menu a list of categories of plug-in that you can choose to display (or not). Those that are chosen will be listed in the left pane of the FX browser window.

You can choose as many or as few of the plug-in types as you want: **DX, DXi, VST, VSTi, VST3, VST3i, AU, AUi, JS, Rewire** and **Cockos**.

Choosing **Instruments** causes all virtual instruments to be listed together: these will also be listed in their native folders (VSTi, DXi, etc) if these are also selected.

Selecting **Recent** causes all plug-ins recently used being displayed here, as well as in their native folders.

Selecting **VST folders** causes all folders with VST plugins to be listed in the left pane under **My folders**.

Selecting **FX Chains** will cause FX chains to be listed.

Show in FX list

This enables you to show in the displayed FX list the **Default preset** (if any, along with the FX name), descriptions, or file names, or both for **JS FX**, the **Video processor** (see Chapter 20), and/or plug-ins whose name begins with a **#**. Renaming a plug-in so that its name begins with a **#** will ensure that it is not shown in the FX browser's FX list.

There are also two **Auto clear search field** (filter) options – when you change your selected folder, and/or when you close the FX browser.

Enabling the option **Auto-clear folder view on close** ensures that the next time the Add FX browser is opened All Plugins will be selected in the left panel.

6.5 Replacing One FX With Another

To replace any FX in a track's FX chain, simply follow this procedure:

1. Display the track's FX chain and select the FX in the chain that you want to replace.
2. From the FX Window top menu choose the **FX, Replace FX...** command. This opens the Add FX window.
3. Select the required replacement FX and click on **OK**.

Any pin connector assignments on the replaced FX will automatically be assigned to the new one.

6.6 Copying Track FX

Any track FX (individual FX or complete chains) can be copied from one track to any other track, or tracks. When a plug-in is copied in this way, the settings and parameter values are also copied with it. You can use standard Windows techniques like **Ctrl C** and **Ctrl V** if you like, but the simplest way is to simply select the required plug-in(s) in the FX window of your source track and use the mouse to drag and drop to the FX button of any other track. This can be done from either the TCP (track control panel) or the MCP (mixer control panel).

Example

For this example, open the file **All Through The Night Folder.rpp** that you saved earlier in this section. If you did not make this file, use any other file which has more than one track.

1. Click on the **FX Button** for the track **Gtr Neck** to open the track's FX Window.
2. Insert the **VST ReaEQ(Cockos)** plug-in into this window.
3. Hover the mouse over the text *VST ReaEQ* in the plug-in window. Press and hold down the left mouse button and, holding it down, drag the mouse to point on the track control area of the **Gtr Body** track.
4. Release the mouse. The **ReaEQ** plug-in will now have been copied into this track.

You can of course repeat this as often as required to copy the same plug-in to other tracks. When you copy an FX in this way, any settings and parameter values that you have set will be copied with it. To copy more than one plug-in at the same time from one track to another, use this sequence:

1. Click on the first plug-in to be selected. Hold the **Ctrl** key down while clicking in turn on each additional plug-in that you want copied. Alternatively, if you want to copy all FX in a chain, click on the first item, then hold **Shift** while you click on the last item in the chain.
2. Use the method described above to drag and drop on or near the FX button of the track to which you wish to copy your plug-ins.

Tip: FX can also be copied from the FX chain of any track to individual media items or takes anywhere in the project. Working with **per item and per take FX** will be explored in Chapters 6 and 7.

6.7 FX Quick Display

Track FX are listed on a track's FX button right click menu (see right). You can open the window for any of these FX direct from this menu.



6.8 Moving Track FX

To move (rather than copy) a plug-in from one track to another, simply hold down the **Alt** key while you drag and drop.

Tip: Hovering your mouse over any track's **FX** button causes a tooltip to be displayed, listing the plug-ins present in that track's FX bin. It displays this information even if the FX chain is set to bypass.

6.9 Managing FX Parameters

REAPER's FX interface window includes for each FX a **Param** button which you can use to help you manage and control the various FX parameters.

Click on any parameter control within the FX window then on the **Param** button to display a menu of choices. The five menu options are Show in track controls, Show track envelope, Parameter modulation, Learn and Alias parameter.

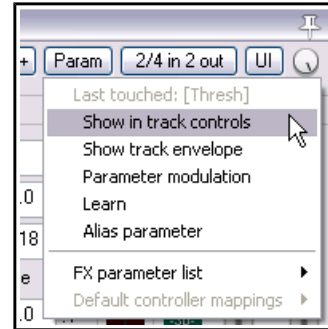

Show in track controls. This adds a control knob for this parameter to both the Track Control Panel (TCP) and the Mixer Control Panel (MCP).

Choose this command from the menu to display a list of parameters for this particular FX. Select any item(s) from the list to add a control knob to the track control panel. An example (using two parameters from ReaComp) is shown here (below right).

To remove any of these controls, right-click over the button and choose **Remove from list** from the menu.

This context menu also gives you access to the four other parameter control tools, Learn, Modulate (Parameter modulation), Envelope (Show track envelope) and Alias (Alias parameter).



Show track envelope. The whole topic of envelopes and automation with envelopes is covered in depth in Chapter 18. For the time being note that you can use this command to add to your tracks automation envelopes for any FX parameters. An example is shown here.

The envelopes can be displayed in their own lanes (as shown here) or over the media item(s). To learn how to do this, see Chapter 18.

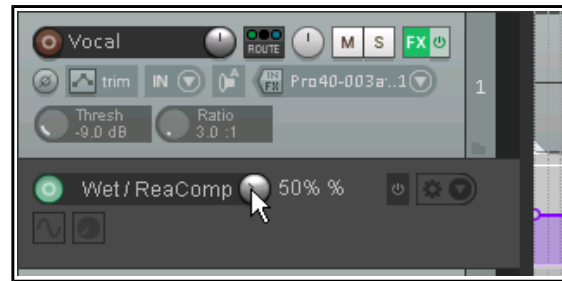

Parameter Modulation. This is a rather advanced topic. Parameter modulation allows you to define a relationship between two parameters so that one is controlled by the other. For example, you might want a threshold's ratio to automatically increase as the threshold is lowered. This topic is explained in Chapter 19.

Learn. If you are using an external MIDI control device you can assign FX parameters to controls (such as knobs or faders) on that external device. This topic is covered in detail in Chapters 11 and 13.

Alias parameter. This allows you to change (just for this instance) the name of a parameter to one that makes more sense to you.

Shown here is an example.



6.10 Changing the Default FX Name

To change the default name of any Direct X or VST FX (but not JS) plug-in:

- Display the FX Browser Window (**View, FX Browser**)
- Right Click over the plug-in to be renamed.
- Choose **Rename FX** from the menu.
- Type the new name and press **Enter**.

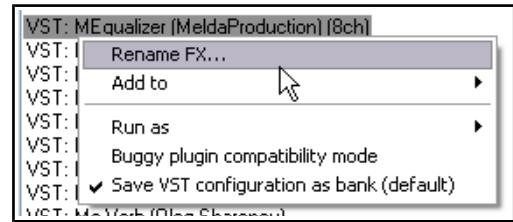

6.11 Renaming Track FX Instances

You can rename individual FX Plug-in instances so that your custom name is used for that FX in both Track View and in the Mixer. Typically this can be used to describe the purpose of the FX. For example, you might want to rename an instance of ReaEQ that has been added to a vocal as "Add warmth" or "More presence" and so on.

To do this, simply select the plug-in and press **F2**, or follow this sequence:

- Right click over the FX Item in either the FX Chain window, or the FX Bin in the Mixer view.
- From the menu, choose **Rename FX instance**.
- Type your custom name.
- Press **Enter**.

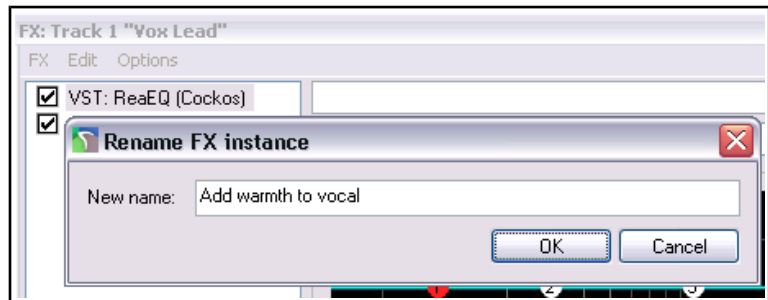

Note that your custom name will only be applied to that single instance of the FX Plug-in in that one track. Other instances will not be affected.

6.12 Using Default FX Parameter Settings

You can specify that any set of FX parameter settings is to be used as a default whenever that FX is applied to any track or item. When you have your settings right, click on the small **+** button and choose **Save preset as default** from the menu. You will need to enter a name for the preset. The use of presets is explained more fully in Chapter 14.

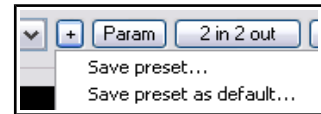

6.13 Hardware Output FX Monitoring

To open the **FX: Monitoring** window you can:

- ◆ Choose **Monitoring FX ...** from the context menu of any project tab, or
- ◆ Click on the **Monitor FX** button at the end of the project tab bar (if you are using project tabs), or
- ◆ Use the **View, Monitoring FX** command from the main menu, or
- ◆ Hold **Shift** while clicking on the FX button of the Master track.

This FX window is the same as any track FX window. You can specify any FX that you want to put on your hardware outputs. These do not show up in renders, do not affect the metronome and are not stored in the project file. Examples when you might use this feature might include:

- ◆ When running analysis FX.
- ◆ Compensating for the acoustic characteristics (perhaps with EQ or reverb) of a particular room.

Notice that:

- ◆ You can right-click on the Monitor FX button to access any plug-in assigned to output monitoring, or to add more FX.
- ◆ Click over the right hand end of this button to toggle bypass status. The button turns red when bypassed.
- ◆ Within the **FX:Monitoring** window, click on the **Param** button then **Learn** to assign control of any selected FX parameter to an external control device.

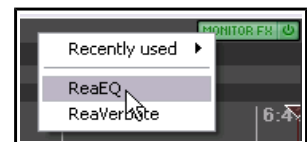

6.14 Optimizing FX Performance

Some plug-ins can be quite greedy in their use of CPU. This especially tends to be the case with delay based FX, such as Delay, Chorus, and especially Reverb. REAPER provides a number of options which you can use to minimize the drain placed on your computer resources by your plug-ins. These options can be found in the **REAPER Preferences** window (**Ctrl P**) under the heading **Audio, Buffering**. This window is shown and discussed further in Chapter 22.

There is no "one size fits all" optimal group of settings. What is best for you depends on various factors, including which processor(s) you are using and which plug-ins. However it shouldn't be too difficult to experiment. Note in particular the following:

- Try using the default settings for **Media Buffering** at first. You can adjust them later.
- **Allow live FX multiprocessing**. Try turning this on if your PC has multiprocessors.
- **Anticipative FX processing**. This can reduce CPU usage, but too aggressive a setting can cause pops and crackles on playback. If working with UAD-1, for best results, both Synchronous FX and UAD-1 Synchronous modes should be enabled. Anticipative FX should be disabled. UAD-2, however, is compatible with Anticipative FX mode and this is recommended for best low latency performance..

Optimize buffering for low latency hardware.

If you find that any particular plug-in or FX chain gives you problems with media buffering or anticipative FX processing, you can disable either or both for individual tracks using the **Track Performance Options** on the Track Control Panel right-click menu.

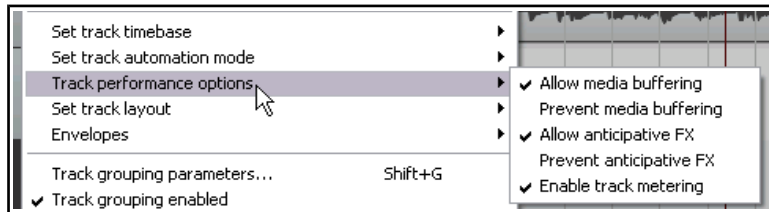

6.15 FX Notes and Comments

The REAPER FX Chain window includes an area for any **Comments** (or notes) that you may wish to make – see example below. Click on the ... button just above the bypass tick box to add comments.

The notes are linked to the individual instance of the specific plug-in.

In the example shown, the comment is only displayed when the 4 band EQ is selected for Track 2, the Vox Lead.

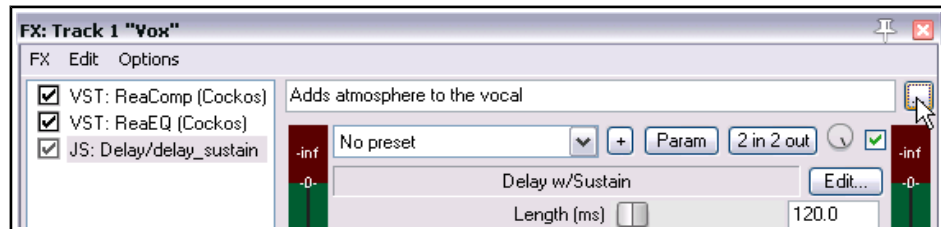

You may add notes for

all or any of a track's FX if you wish, but only one comment at a time will be displayed in the track's FX window.

You can open the comments in a separate window of their own by clicking on that ... button . You may have as many as you wish of these comment windows open at any time.

6.16 Wet/Dry Mix and Bypass

The wet/dry mix control was mentioned in Chapter 2. Click and hold your mouse over the small rotary fader near the top right corner of the plug-in window and you will see the wet/dry balance for that plug-in displayed as text (above right). At 100% wet (the default) the plug-in is applied to the track in the way that you would normally expect. Click and drag the mouse on this to adjust this value to create a mix of the dry signal (the audio stream with no effect applied) and the wet signal (the audio stream with the effect fully applied. For example, set to 100%, this mix is fully wet. At 0% it is fully dry (effectively sounding the same as bypass). At 50% the dry and wet signals are mixed together in equal amount.



Notice also that the small check box to the immediate right of this control has a bypass function. Leave it ticked as shown and the effect (as determined by its various parameter settings including the wet/dry mix control) will be applied to the track. Untick this box and the effect is bypassed.

6.17 Plug-in Delay Compensation

By default, REAPER uses plug-in delay compensation (PDC) to ensure that audio remains time aligned. It does this by adjusting for any latency caused by any plug-in, such as can arise with some convolution reverb plug-ins for example. The latency for any track is displayed in the bottom left corner of that track's FX chain window. For example, a display of 256/512 spls would mean that one of the FX requires a latency of 256 samples: REAPER rounds this up to a number of blocks based on your buffer size. All other tracks will be delayed to match the track with the greatest latency.

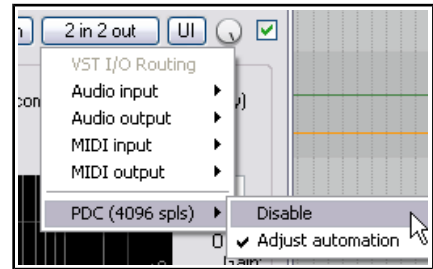

If you encounter circumstances in which PDC is creating problems (for examples, dropouts or excessive latency) then it can be disabled for any plug-in from the pin connector button (shown here labelled "2 in 2 out") context menu. Note too that PDC is disabled when feedback routing is employed.

6.18 Opening a File in Recovery Mode

Any computer program will crash given the right (or wrong?) circumstances. REAPER is very stable, but nevertheless there may be occasions when you experience a crash. This can be caused by a problem with some third party VST, VSTi, DX or DXi plug-in.

If this happens, you should enable the option to **Open with FX offline (recovery mode)** when re-opening the file from the **File, Open project** dialog box (see right). This will open the file with all FX set offline. By reintroducing them online one at a time, you should be able to identify which is the plug-in that is causing the problem. To then fix the problem you should remove this plug-in and replace it with another of equivalent functionality.

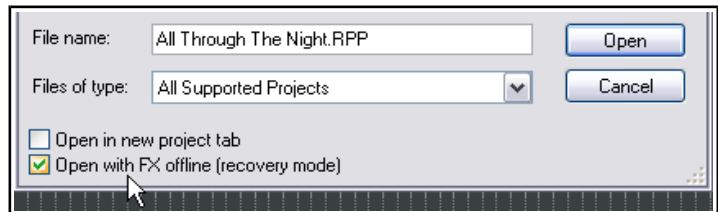

Another method is to hold down **Ctrl Shift** while you open a file from the **File, Recent projects** menu.

6.19 Stem Rendering

Stem Rendering is a technique that can be applied to ease your CPU load, to prevent it from becoming overstressed. The item is rendered to a new track, whilst the original track remains but is automatically muted and its FX are bypassed. If you later wish to change the FX in a stem rendered track, you can delete the rendered track, unmute the original, and make your changes. This is how you make a stem track:

1. In the **Track Control Panel** area, right-click over the track number.
2. From the menu, choose **Render/freeze tracks**, then one of the **Render tracks to ... stem tracks (and mute originals)** commands. Your choices are **mono**, **stereo** or **multichannel**.

The first of these commands will render to a mono item (as shown here). The second will always produce a stereo item. The number of channels produced when



multichannel is selected will be determined by the number of channels that you have defined for the track. By default, REAPER tracks comprise just 2 channels: in this case, both the stereo and multichannel options will produce the same result. As well as track FX, any audio or MIDI received from sends from other tracks is included in the rendered material.

Stem rendering has a similar effect to freezing tracks (see section after next). One main difference is that (unlike freezing) stem rendering leaves both the rendered and the unrendered tracks in the project. If you only wish to render the track FX without keeping both tracks in the project, you might wish to consider using one of the **Render/freeze** freeze actions instead. These are covered in the couple of pages that follow this one.

Stem rendering is also available with an extensive range of options (such as output format and quality) using the **File, Render...** command. This opens the **Render to File** dialog box. See Chapter 21 for details.

6.20 Rendering a Group of Tracks to a Single Track

This example uses the **Render to File** dialog box, which is explained in detail in Chapter 21. You can apply stem rendering to a group of tracks, so that they will be mixed down to a single audio file. To do this:

1. Put the required tracks in a folder.
2. In the Track Control Panel, select the folder. No other track should be selected.
3. Choose the **File, Render** command.
4. Make sure your selected options include **Stems (selected tracks)** and Channels **Stereo** or **Mono** (as you wish) as shown on the right. If you wish, also select the option to **Add rendered items to new tracks in project**.
5. Select your output format (e.g. WAV) and format specifications (e.g. 24 bit).
6. Click on **Render 1 file...**

In the example shown below, the output of the Guitars folder has been rendered to a single stereo track. This has been added to the file and the folder has been muted.

When working with multichannel tracks you can also render your output in multichannel format. You will need to select the required number of channels from the Channels drop down list in the **Render to File** dialog box.

You'll learn more about file rendering, including multichannel rendering, in Chapter 21.

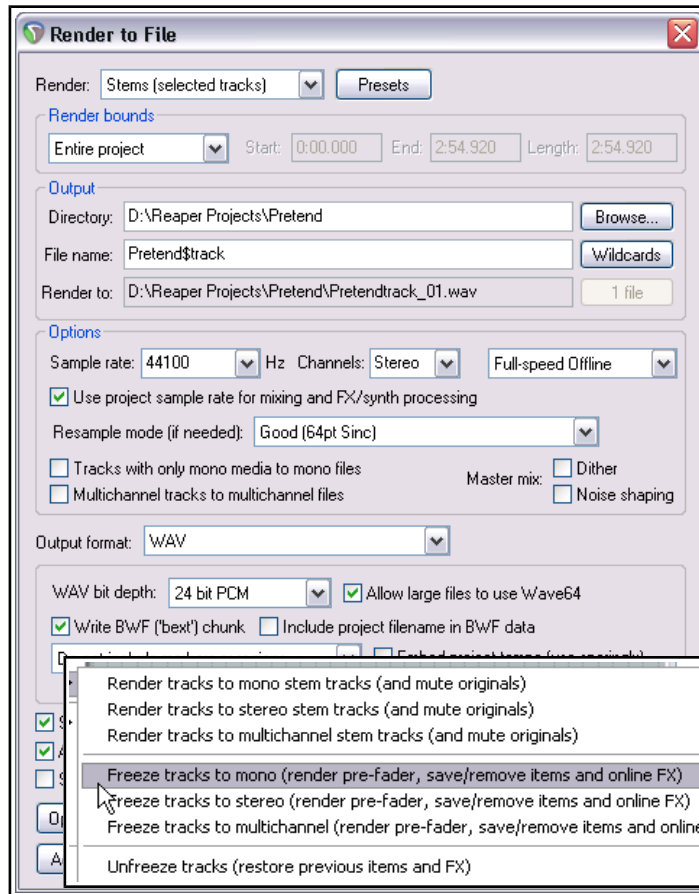

6.21 Freezing and Unfreezing Tracks

The **Freeze tracks** actions (from the Track right click menu **Render/freeze tracks** command) are used to freeze any track in place, replacing its

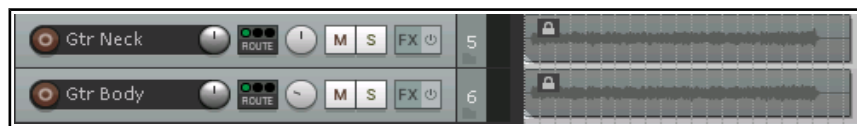

contents with a single rendered audio item. The first of the freeze actions shown (above) will produce a **mono** audio item for each track frozen, the second **stereo** and the third **multichannel** (according to the number of track channels). If more than one track is selected, each will be rendered separately.

On line FX are applied to the rendered item, as is the content of any signals sent to the rendered channels from other tracks. Where these include MIDI data or items, they will be rendered as audio. Both on line FX and receives are then removed from the track. Note that a MIDI item with no synth attached to it will be rendered as silence. Where a synth is present, it is the output of the synth that will be rendered.

When a track has already been frozen, **Unfreeze tracks** will appear on the above menu as an action that can be used to restore the track to its state at the point in time that it was frozen. Both the FX chain and any receives will be restored. Other points to note are:

- ◆ A track can have further FX and receives added to it after it has been frozen. In this case, if you then freeze the track again, these FX (along with audio and or MIDI material from the new receives) will be rendered together with the existing frozen material to another new audio item.
- ◆ Each unfreeze action will remove the previous freeze on that track and restore it to its state at the time of

that freeze action. Thus, if a track has been frozen, had more effects added and been frozen again, then you will need to unfreeze it twice if you wish to restore it its state immediately before first being frozen.

Using the Track Manager

Freezing can also be handled using the **Track Manager**. Choose **Track Manager** from REAPER's main **View** menu.

You can select any track(s) from the list (in the example shown, tracks 3 and 4 are selected) then click on the **Freeze** button for a menu of freeze choices (mono, stereo or multichannel).

The number of times any track has been frozen (up to a maximum of 8) will be shown in the Freeze column. In this example (right), tracks 3 and 4 have now both been frozen once.

The **Unfreeze** command will be added to the Freeze menu when that menu is displayed with a frozen track selected. Moreover, this menu will also include an option to display the freeze details for that track (see above).

You can read more about the Track Manager in Chapter 12.

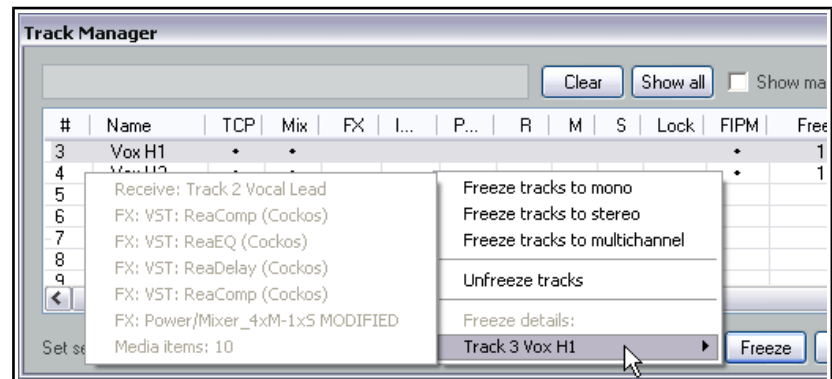
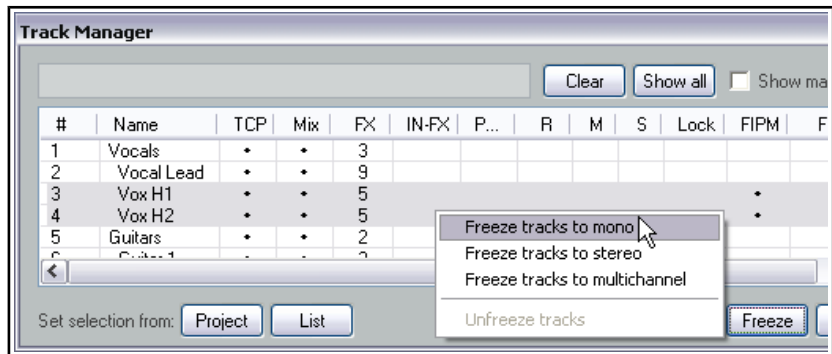

Selected FX Freeze

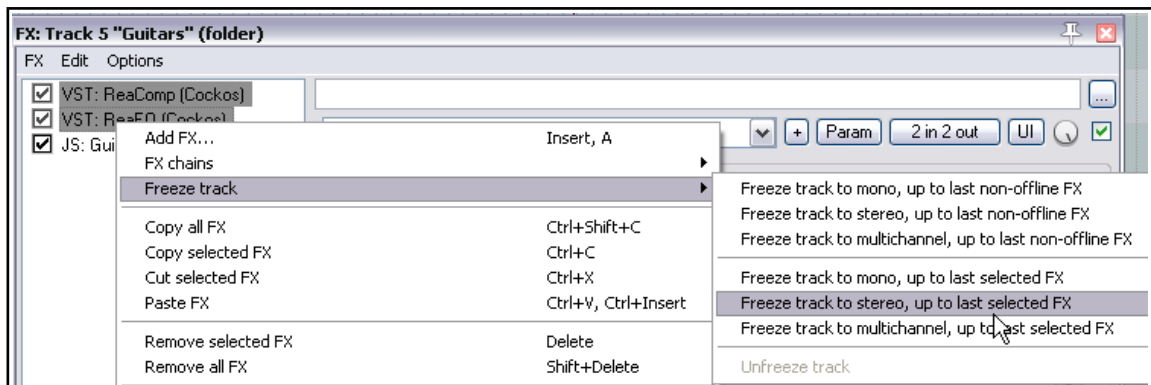

Other options, available from a track's FX chain window, are to freeze a track up to its last on-line or selected FX, as you wish - see above. In this case, only the first two FX (ReaComp and ReaEQ) have been selected. The action **Freeze track to stereo, up to last selected FX** will cause the compression and EQ to be frozen on to the track. These two FX will be removed from the track's FX chain. The third (JS) effect will not be rendered to the new audio item. It will remain, and can be further adjusted, or removed altogether as the user wishes.

One useful action (accessible from REAPER's Action List window) is **View: Show track freeze details**. This can be used to display freeze history and details for any frozen track. Chapter 15 explains in detail more about actions and about how you can assign them to toolbars or to your own shortcut keys.

6.22 Vertical/Horizontal FX Tree Display

The FX tree can be displayed in a vertical layout (the default) or horizontal layout (shown here). The display can be toggled between these two options by double-clicking on the boundary between the two sections, on the double-headed arrow mouse cursor (as shown).

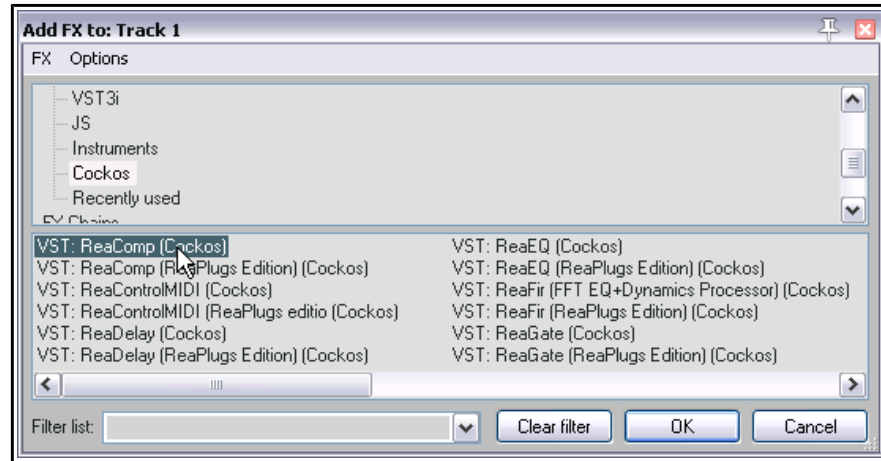

6.23 Adding FX Comments

Near the top right corner of every track FX window there is a small button displaying three dots. Clicking this opens a window where you can type any comments you wish to make about the currently selected FX and its settings.

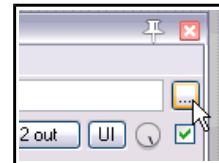

6.24 Installing Extra JS Plug-ins

You can find more JS plug-ins that are available free of charge at stash.reaper.fm/tag/JS-Effects

To install any of these, follow this sequence:

1. Download the effect and (if necessary) unzip the file.
2. If the JS effect file has a .txt extension, edit the file name to remove this.
3. Copy the effect to your REAPER Application Data Effects folder. You can find this by giving (within REAPER) the command **Options, Show REAPER resource path ...** If you wish, you can place it in a sub-folder within the Effects folder.
4. Close and restart REAPER.

Some JS FX come with other files (such as data files or image files). As a rule, data files are placed in a sub-folder in the Application Data folder, and other files are placed relative to the JS FX file. In most cases where this is necessary, the JS effect developer will supply specific instructions with the effect.

6.25 Track Templates Revisited

Don't forget that as well as saving FX chains by themselves, you can include them with other track settings (such as name, pan settings, volume levels, etc.) into track templates. Remember too that you can use the **Track, Save tracks as template** command to save a whole selection of several tracks into a single track template. See also Chapter 3.

6.26 ReaEffects User Guide Supplement

You will find many examples in this User Guide of the use of various COCKOS effects, especially in Chapter 16. In addition, a free PDF Reaper COCKOS Effects Summary guide can be downloaded from the following URL:

<http://www.cockos.com/~glazfolk/ReaEffectsGuide.pdf>

Note that this link is case sensitive.

6.27 Drag and Drop from FX Browser

A handy way to add FX to any track or media item is to drag and drop from the FX browser. To do this:

- ◆ Display the FX Browser window (**Shift F** or **View, FX Browser**). This will be displayed as a floating window but can be docked at the bottom, right, left or top of your REAPER window. Basic docking was introduced and explained in Chapter 2. A more in depth examination of the topic can be found in Chapter 12.

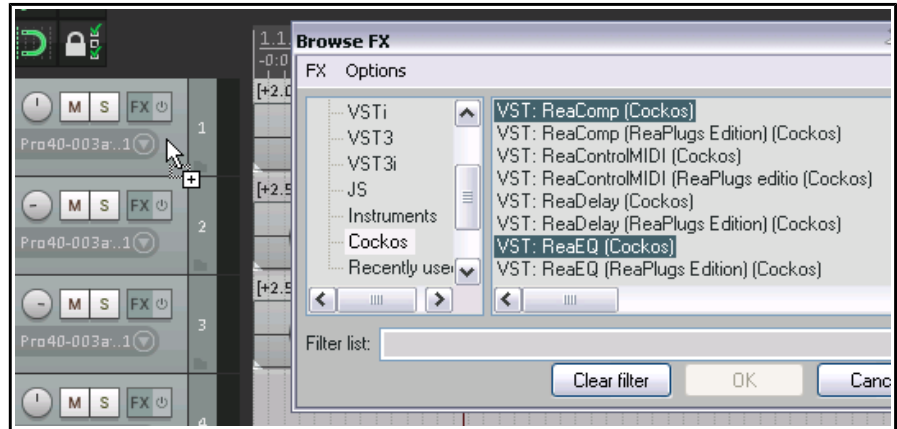

- ◆ Simply drag any required FX from the Add FX (FX browser) window: to add the FX to a track, drop on that track in the track control panel, or to add the FX to a media item, drop on that media item.

Tips: You can use **Ctrl Click** to select more than one FX at a time, as shown above. Also, if you have previously created any FX chains, you can select **FX Chains** from the FX browser and drag any complete chain to any track or item.

6.28 Audio Signal Flow Chart: Master Track

This diagram illustrates specifically the audio flow for the Master Track.

REAPER Audio Playback Signal Flow - Master Track

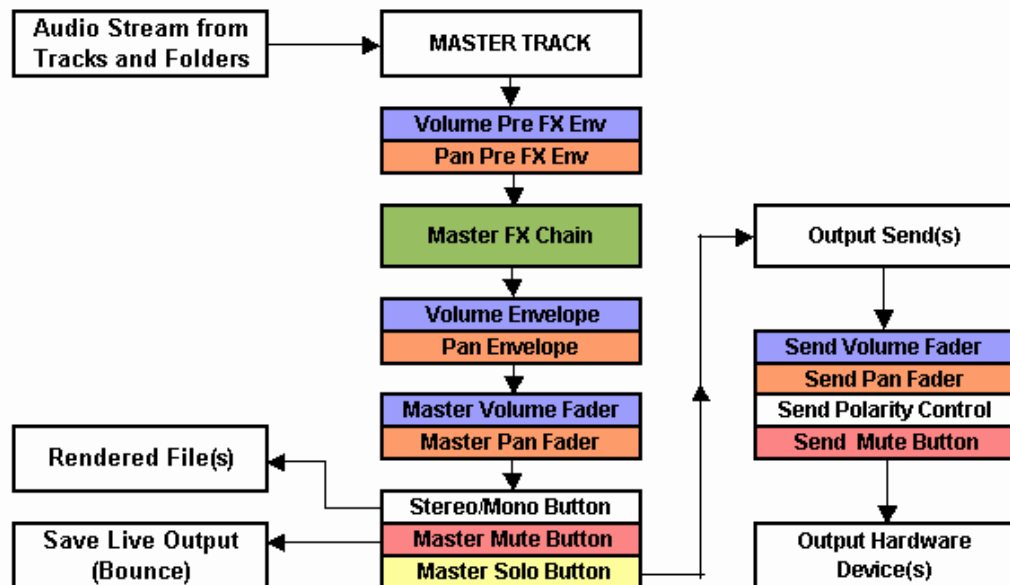

6.29 Audio Signal Flow Chart: Tracks and Folders

The two diagrams that follow (in this section and the next) illustrate how audio signals flow thru REAPER's tracks to the master and to your output devices. Some of the items shown in these charts (e.g. Item/Take settings) have not yet been discussed in this User Guide. They will be covered later, mostly in Chapter 7.

REAPER Audio Playback Signal Flow - Top Level Track or Child Track

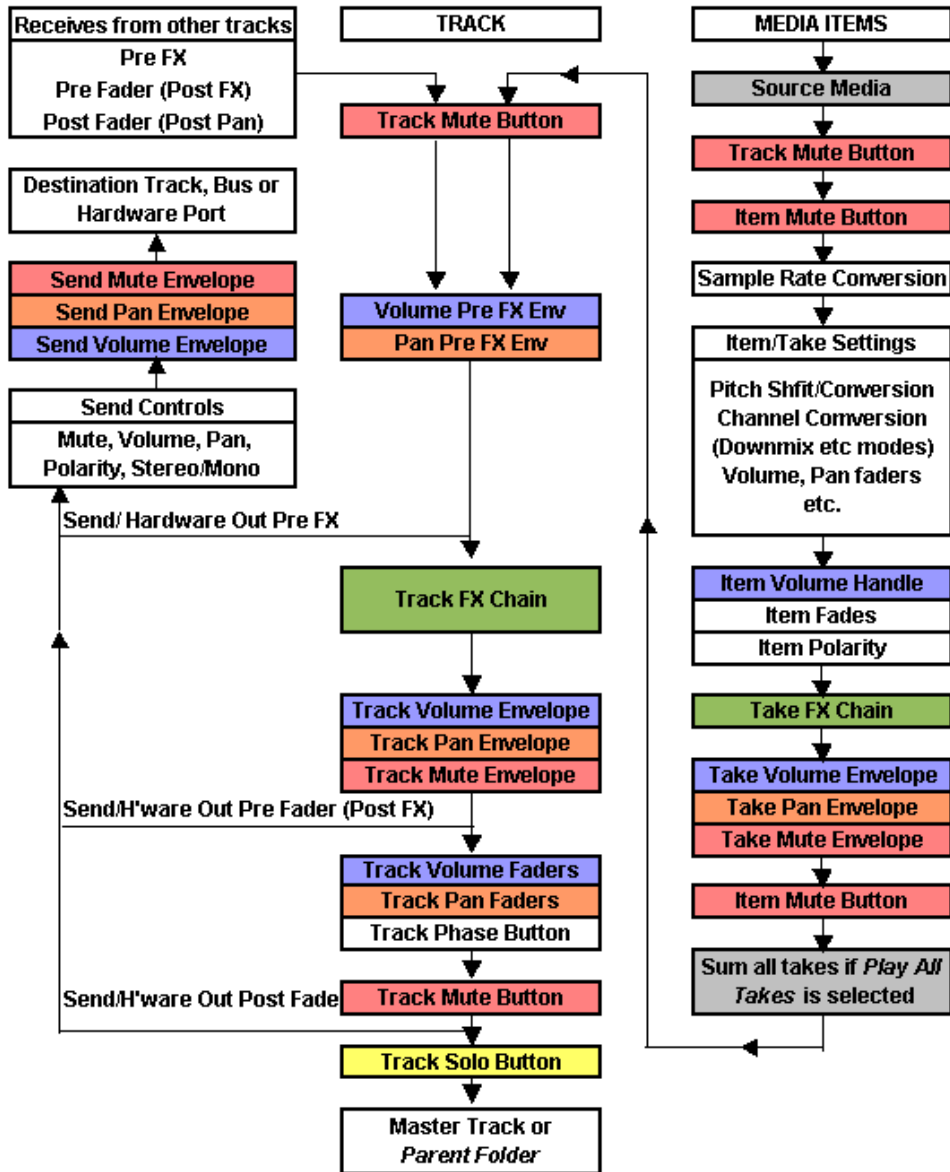

Notes:

1. The track mute button is shown more than once (near the beginning and near the end of the chain). This is because it does not only mute at the beginning (so that for example, all media items are effectively muted), it also mutes at the end (so that, for example, a synth in the track FX chain that is fed MIDI data via a receive from another track is also muted).
2. If track mute and track solo buttons are both enabled, then solo overrides the mute.
3. If the Master is soloed, direct outputs to hardware from tracks/folders will not be processed.

7 Editing Tracks and Items

Note: Some of the arrange view illustrations used in this chapter use the REAPER 4 default theme and color scheme. The information and instructions, however, are still accurate and correct for REAPER 5.

7.1 Using an External Editor

You can specify up to two third party programs (such as Adobe Audition, Audacity, Wavosaur or Sound Forge) which you wish to integrate with REAPER for editing your audio media items. To do this:

1. Choose the **Options, Preferences** command, then **External Editors**.
2. Click on the **Add** button
3. Use the **Browse** buttons (shown right) to identify and select your preferred wave editor or editors.
4. Click on **OK**, then **OK** to close the Preferences window.

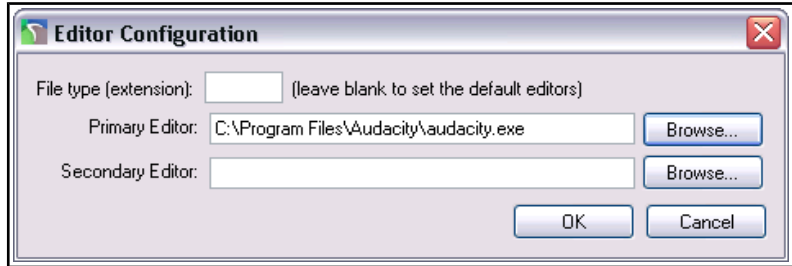

Notice that you can specify different editors for different file types, e.g. WAV, or MP3.

To use your external wave editor:

There are two main ways you can access your preferred external editing program from within REAPER:

- Select the media item and press **Ctrl Alt E**.
- Within a REAPER project, right click over the media item that you wish to edit. From the menu, choose either **Open Items in editor** then, from the sub-menu, select either the option to open the item itself or to open a copy of the item.

Unlike versions of REAPER earlier than 4.0, by default double-clicking on an audio media item will no longer open it with your primary editor. This behavior can be

changed thru the **Preferences, Editing Behavior, Mouse Modifiers** page if you wish. This topic is covered in Chapter 15.

If the external editor works destructively on your files then the safer option is to open a copy. This copy will then be inserted into your track when you

save it, close the editor and return to REAPER.

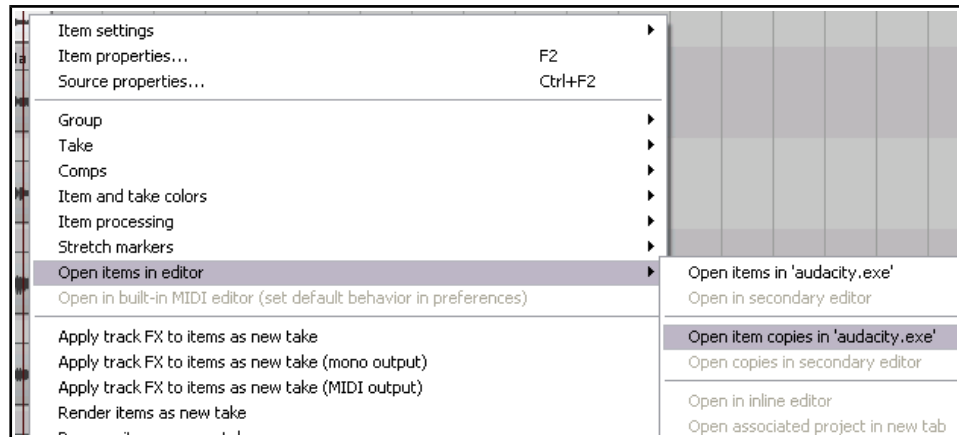

7.2 Editing Items in REAPER

The topic of editing items in REAPER is a big one. REAPER features a comprehensive range of editing techniques for managing the items within your projects. If you have worked with other audio software, you might find REAPER's ways a little strange at first. The first question you might have when you look at the screen is, "Where are all the editing tools?" The answer is ... there aren't any! At least, there aren't many the first time that you use REAPER! But as you are about to see, that doesn't mean that REAPER isn't up to the job. You just get the wave editing features that you need, but without the screen clutter. What's more, you can create and add as many editing tools of your own as you like. We'll get to this in Chapter 15.

There are some basic concepts that you need to understand about REAPER's design philosophy and structure before learning individual editing techniques. For example:

Up and Running: A REAPER User Guide v 5.24

- Item Editing in REAPER is non-destructive. Edits made to items are unique per item and do not alter the content of the source file. You can experiment knowing that your original recorded files are safe.
- Item Editing in REAPER basically consists of selecting an item, or a portion of an item (range), then doing something to it – such as splitting it, deleting it, copying it or moving it.
- Sometimes a number of steps might be required to achieve an editing task. If so, you can assign a single keyboard shortcut to the entire sequence. Just how to do this is covered in Chapter 15.
- If you really miss having editing tools, then fear not. You can quite easily create your own tools and toolbars for this (or any other) purpose. This topic is covered in Chapter 15.
- To a very large extent, you can customize REAPER's editing behavior thru the **Editing** settings within your **Options, Preferences** window. We'll get to this later in this section.

In a moment, we'll be working thru REAPER's many editing facilities and features. Before we do, don't forget that when you are editing you have available not only the **Edit, Undo** command but also the **Undo History** window (covered in Chapter 2). Remember that if you get into trouble, this Undo History window can be used to restore a project file to any earlier state. How to enable these various options is explained in Chapter 2.

7.3 REAPER's Smart Editing

REAPER's smart editing features enable you to do many of the most commonly required editing tasks quickly and easily. In this section, we will look at smart editing techniques for moving, copying and deleting media items, selections of media items and parts of media items. To use them, make sure that the option **Loop Points Linked to Time Selection** is **disabled**.

The table below shows REAPER's default behavior for various mouse actions. You can change any of these by selecting the context **Media item** and **Left drag** on the **Mouse Modifiers** page of your Preferences.

To do this with the mouse ...	You need to do this ...
Move item or selection of items ignoring time selection	Drag and drop.
Move item or selection of items ignoring snap and time selection	Shift drag and drop.
Copy item or selection of items	Ctrl drag and drop.
Copy item or selection of items ignoring snap	Shift and Ctrl with drag and drop.
Move item contents (within item)	Alt drag and drop.
Adjust item pitch fine	Shift and Alt drag and drop.
Render item to new file	Ctrl and Alt drag and drop.
Copy item, pooling MIDI source data	Shift Ctrl and Alt drag and drop.

Shown right is an example of how you might change any of these. In this example, we are in the process of changing the default click and drag behavior from **Move item ignoring time selection** to **Move item: just move**. This will enable us to move any selected area of an item just by dragging and dropping it. You'll find more of that in Chapter 15.

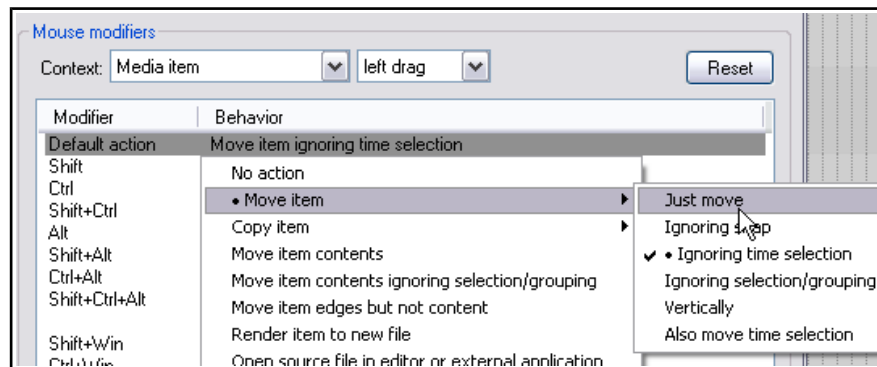

Tip: If you accidentally move an item it can be restored to its original position by choosing **Item processing** then **Move item to source preferred position** from the media item right-click context menu.

7.4 Standard Windows Editing

Many of the basic editing tasks that you will be performing in REAPER involve the use of fairly intuitive standard Windows procedures for selecting and manipulating items. There are also some extra ones. Here is a summary.

Select Items

- Select an item by clicking on the item.
- Select multiple items by using **Ctrl Click**.
- Select adjacent items by using **Shift Click**.
- Select groups of items by right-clicking and dragging a marquee around the items. It is not necessary to marquee the whole of an item to select it (see above right). The marquee feature can, however, be made to behave differently by using any of a number of modifier key options (see **Marquee Modifiers** table below).



These techniques can be used in REAPER in several contexts – for example, **Ctrl Click** and **Marquee** can also both be used to make multiple note selections in the MIDI Editor (see Chapter 13).

Split Items

Splitting items is used in several REAPER editing functions. Be sure to familiarise yourself with the following:

- If no item is selected, pressing **S** will do nothing.
- If item(s) are selected, pressing **S** will split all selected item(s) at the edit cursor position.
- If there is a time selection current, pressing **Shift S** will split all selected Item(s) at the beginning and end of the time selection.

If an item with any FX is split, then both the resulting items will contain the FX. This can be changed in your **Options, Preferences, Media** page by disabling the option **Duplicate take FX when splitting items**.

Heal Split Items

To reconnect media item that have previously been split:

- Select the media items in the track.
- Right click over any media item within the selection and from the menu choose **Heal splits in items**.

Heal is different from Glue. In short, heal restores items to their original state, whilst glue renders them to a new file. Glue will be discussed later in this chapter. Note also that if a number of previously split items each containing an FX chain are healed, then only the FX Chain of the first of the items is retained.

Cut/Copy Items

Apart from smart editing (see previous section) there are other ways to copy or cut items in REAPER. These are based on standard windows techniques

- Use the keyboard shortcut **Ctrl C** to copy or **Ctrl X** to cut any selected item(s) in its entirety. Note that if a time selection is current, **Shift Ctrl C/Shift Ctrl X** will copy/cut only that current time selection, not the whole item. You can use the Actions Editor (Chapter 15) to change this behavior if you wish.
- Right-click on an item and select **Copy items** or **Cut items** from the menu.
- Select an item, then select **Edit, Copy items/tracks/envelope points ignoring time selection** or **Cut items/tracks/envelope points ignoring time selection** from the menu.

Note: Copying MIDI Items in Arrange View: Special considerations that need to be taken into account when you are copying MIDI (rather than audio) items in arrange view. These are explained in Chapter 13.

Paste Items

- Use **Ctrl V** to paste an item at the cursor position. If a track is selected, the item will be pasted into the selected track. If no track is selected, the item will be pasted into the last track that was selected in the TCP. If you give focus to the main arrange view window before pasting, a new track will be created.
- Select a track and use **Edit, Paste** to paste the item at the current edit cursor position.

Copy or Cut Part of an Item

For those times when you prefer not to use smart editing you can use the Windows clipboard.

- Select the item then make the time selection.
- To copy or cut the selected area, first make sure that focus is on the main arrange view window, then to copy use **Edit, Copy items/tracks/envelope points within time selection** or right-click on the item and select **Copy selected area of items** from the menu, or press **Ctrl C**, or

Up and Running: A REAPER User Guide v 5.24

- To cut the selected area, use **Cut items/tracks/envelope points within time selection** or right-click on the selected area and select **Cut selected area of items** from the menu, or press **Ctrl X**.
- Select a track in the TCP, position the cursor in arrange view and choose **Edit, Paste** from the menu.

Delete Items

Delete completely removes the item from the track. Note that it does not remove the media file from the project directory. There are several ways to delete items. Where an item has several takes, any of these actions will delete all takes, not just the active one. See Chapter 8 for how to deal with individual takes.

- Use the **Delete** key to delete selected item/s.
- Right-click on a selected item and select **Remove items**. This will delete any selected items.
- Select **Item, Remove items** from the main menu.

Show Overlapping Items In Lanes

You might wish to place several overlapping media items on one track. If so, consider whether or not you wish to crossfade them. Crossfades can be applied manually, or automatically, by enabling the Auto Crossfade tool on the toolbar. Crossfade behavior can also be managed using the Crossfade Editor which will be examined later in this chapter. You might also wish to enable **Show overlapping media items in lanes** on the **Options** menu. The maximum number of lanes to be used can be set on the **Appearance** page of your Preferences.

Move Items: Special

Shortcut keys exist for moving items in ways that might be difficult to control with the mouse. For example:

Default Shortcut Key	Purpose
Num Pad 1	Slide item a little to the left
Num Pad 3	Slide item a little to the right
Num Pad 4	Move item a little to the left
Num Pad 6	Move item a little to the right
Num Pad 8	Move item up one track
Num Pad 2	Move item down one track

Note: This feature is often referred to as “nudge”. With REAPER, nudging is relative to the screen display. For example, if you are zoomed in very closely on an item, then nudging left or right will move or slide it backward or forward thru a much smaller unit of time than if the view was zoomed out to the full project.

Tip: Double click on a track’s index number in the Track Control Panel to select all the items in that track.

Marquee Modifiers

Modifier keys exist for changing the marquee behavior when you right-click and drag. By default, these are::

Modifier Key(s)	Purpose
Right-click drag (no modifier)	Marquee select items.
Shift Right click-drag	Marquee add to item selection.
Ctrl Right click-drag	Marquee toggle item selection
Alt Right click-drag	Marquee select items and time
Shift Alt Right click-drag	Marquee select items and time ignoring snap.

mouse modifiers

Context: Arrange view right drag

Modifier	Behavior
Default action	Marquee select items
Shift	Marquee add to item selection
Ctrl	Marquee toggle item selection
Shift+Ctrl	
Alt	Marquee select items and time
Shift+Alt	Marquee select items and time ignoring snap
Ctrl+Alt	
Shift+Ctrl+Alt	Hand scroll

You can change any of these modifiers and/or add others of your own choosing, using the **Mouse Modifiers** page of your REAPER Preferences. More information about how to do this is given in Chapter 15.

7.5 Editing Behavior Preferences

Familiarise yourself with REAPER's main editing behavior preferences and how they work. If you do, you will find life getting a lot easier! They are displayed on the **Editing Behavior** page of the **Preferences** window. These are explained in Chapter 22, but in short, some of the most useful of these include:

- ◆ Whether to move the edit cursor when performing various actions – e.g. changing time selection or inserting media.
- ◆ Whether by default to link loop points to time selection.
- ◆ Which focus point to use as the center when zooming horizontally and vertically. These two important options put you in control of REAPER's zoom behavior. Selecting mouse cursor allows you to simply point and zoom with the mousewheel.

The option whether to move the edit cursor when selecting a media item is no longer on this page,

but can now be set using the **Media item left click** context on the mouse modifiers page. The default behavior for this is **Select item and move edit cursor** but this can be changed to just **Select item**.

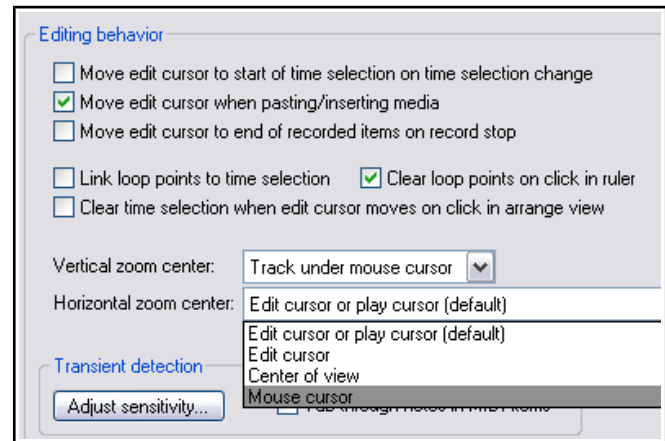

7.6 Separating Loop Selection From Time Selection

The setting **Link loop points to time selection** (on your **Preferences, Editing Behavior** page) determines whether by default the loop points are linked to your time selection. When linked, this means that when you select a time area other than that currently selected, the loop selection changes with it. At any time you can override the default behavior by using the toggle command **Loop points linked to time selection** on REAPER's main **Options** menu. Even when this option is disabled (i.e. not ticked), you can still use the **Alt** key while you click and drag along the timeline to set both the time selection and the loop selection together.

Example

For this example we will be assuming that **Loop points linked to time selection** has been turned off.



In this first example, we have dragged along the timeline to create a loop.



Now we have dragged within the track area, just below the media item.

A new time selection is made within the loop area, but the original loop selection remains.



Next, we have right-clicked over the area and chosen **Split items at time selection** from the menu. We now have a separate item (for example, to be muted, or to which we could add FX), but the original loop area is still selected.



Here we have added FX to the newly split item. We could now make a different time selection, which we could also edit as required.

Notice that we can carry on working with different times selections, but our original loop area remains intact. You can play this looped area over and over again while working on different time selections within it.

7.7 Snapping with Combined Snap/Grid Settings

You have already learnt (Chapter 5) how to define grid settings. These determine whether or not a grid is displayed in your track area, and if so how that grid appears. The **Snap/Grid Settings** window (shown below) can also be used if you wish to ensure that various actions (including time or loop selection) and/or items are automatically snapped into position according to your settings. This, for example, might be to the nearest beat.

The Snap/Grid Settings dialog box is accessed by choosing the **Options, Snap/Grid Settings** command, or by the keyboard shortcut **Alt L**, or by right clicking on the Grid button on the REAPER toolbar. The keyboard shortcut **Alt S** is used to toggle the Snap feature on and off. You can decide whether you want snapping applied in all or any of a number of ways, including:

Media Items: Ensures that media items when created, moved or edited will be snapped to your settings - at their start, at both the start and the end, or as determined by the mouse position at the time.

Selection: Determines whether your time and loop selections should be snapped.

Cursor: Determines whether your cursor should be snapped.

Cursor to edge of media items on any track: Good for navigating to item start, end, splits, etc.

Snap to project sample rate: Enables items to be snapped to items samples, cursor, markers, loop points and envelope points to snap to samples.

Notice the **Snap Distance** settings. These enable your snapping to be more flexible. For example, you might set your grid spacing at, say 50 pixels, specify snap distance of, say, 5 pixels and turn off the option to **Snap to grid at any distance**. This will ensure that snapping to grid will occur only when you click the mouse within 5 pixels of one of the grid lines. Otherwise, the cursor will be positioned at the exact place where the mouse is clicked. Notice that you also have the option to make snapping **Relative to Grid**.

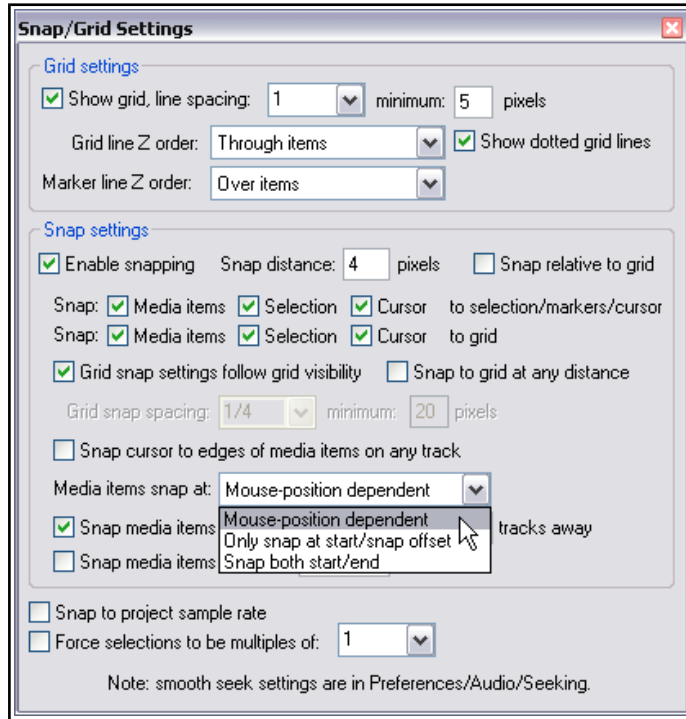

7.8 Snapping with Separate Snap and Grid Settings

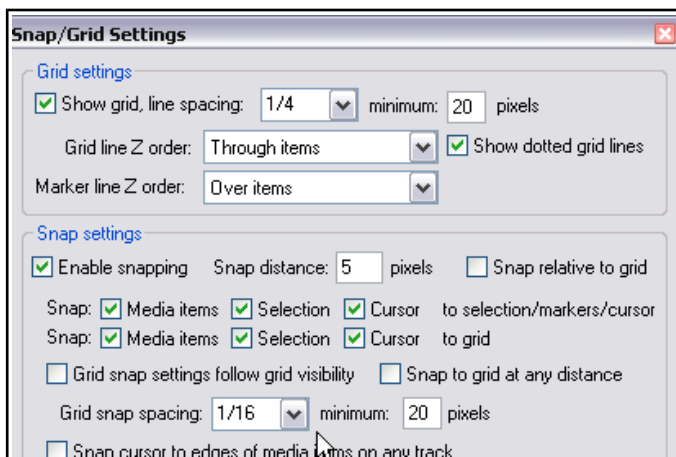

In the above examples, REAPER was set up to use the same set of snap parameters for grid display as was used for snapping. In other words, the snapping would take place to the nearest grid position.

Let's now see what we can do if we disable the option **Grid snap settings follow grid visibility**.

We have also changed the **minimum pixels** setting for **grid line spacing**, in this case to 20 pixels, whilst still specifying (at the point where the cursor is shown on the screen shot) a **grid snap spacing** of one sixteenth beats.

This produces a less cluttered display on the screen. Provided you have zoomed into your project sufficiently, gridlines will be shown for

every quarter beat but snapping will take place between as well as on the gridlines, at every sixteenth beat.

Notice also the **Media items snap to** option. This can be set to **Snap both start/end**, **Only snap at start/snap offset** or **Mouse position dependent** (that is, at whichever position the mouse is nearer at the time, the start or the end).

Tip: When snapping is enabled, this can be overridden when selecting a loop along the timeline by holding down the **Ctrl** key while you make the selection.

7.9 Trim Behind When Editing

The toggle command **Options, Trim content behind media items when editing** can be used to ensure that existing material is effectively replaced by new material which as a result of some editing action is placed over it. This option is also available by right-clicking on the Auto Crossfade icon on the main toolbar. The easiest way to understand what this feature does is to look at an example of what happens when you move one item onto another with "trim behind" disabled and enabled. In this example, we are assuming that auto-crossfade has been turned off.

The easiest way to understand what this feature does is to look at an example of what happens when you move one item onto another with "trim behind" disabled and enabled. In this example, we are assuming that auto-crossfade has been turned off.

Let's first recall how REAPER behaves with trim behind disabled (the default setting).

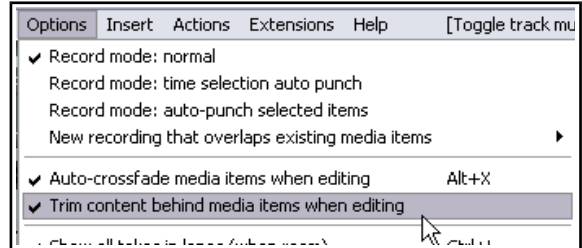

1. Shown here are two guitar tracks.



2. We drag and drop the item from the second track over the top of the first.



3. If we now enable free item positioning on the track and increase the track height, by dragging the item on top below the original media item, we can see that both the original and the new item are now stored in this track.



Let's now see what happens if we repeat this exercise, but this time with the option **Trim content behind media items when editing** enabled.

Steps one and two would appear to be the same as before. But look what now happens at step 3:



This time, when we allow free item positioning and drag the new item down, there is nothing behind it! The original item has been replaced with the new one.

This example has been included only as an illustration and an example. It does not mean that you have to make use of free item positioning if you wish to work with "trim behind" enabled.

7.10 Item Take FX

REAPER allows you to apply FX not only to individual tracks but also to individual media item takes within a track. Suppose, for example, that you wish to add an effect (such as reverb or delay) to just part of a track. You can split the track media into several items and apply the effect only to those items where it is wanted. If you have selected the option to display the **Per take FX** and **No FX** item icons (**Options, Preferences, Appearance, Media**) you can click on any item take's **FX** button to open its FX window. This topic will be explained in more detail later in this chapter. Otherwise you can select a media item and use the default keyboard shortcut **Shift E**.

To add a plug-in to a media item:

- Select the Media Item.

Up and Running: A REAPER User Guide v 5.24

- Click on the **FX** button or press **Shift E** to open the **Item FX Chain**. The **Add FX to Item** window will be displayed.
- Double-click on the Plug-In.
- Adjust the parameters. then close the FX Window. If you now hover the mouse over the item's FX button, you will see a tool-tip showing the FX chain.



If you find this method too “fussy” then try this. You can simply drag and drop any FX from the **FX Browser** window straight on to any media item. You can drop the FX anywhere on the item. When FX have been added to an item, then the FX names will be displayed in arrange view together with the item name (see above).

Important note: Where an item has more than one take, be careful to make sure you have selected the correct required take before opening the item FX chain. This is because FX are assigned to individual takes.

Tip: You can also add recently used FX to an item, or open an existing effect for editing, by right-clicking over the item's FX button to display a context menu (see above).

Managing Item FX – Summary Table

To do this ...	You need to do this ...
Add a plug-in to an item's FX chain	Drag and drop from FX browser window on to the item.
Open and view an item's FX chain	Select the item, press Shift E .
Delete an item's FX chain altogether	Select the first item in the chain then hold Shift while selecting the last item. This will cause all items in the FX chain to be selected. Then press Delete .
Copy an item's FX chain to another item	Select the items, then drag and drop the FX from one item to another. If the FX button is visible, just drag and drop from the FX button on to the destination item.

Shown here are the settings which determine if and how the various buttons are displayed for individual media items. We'll return to this in detail later in this chapter, but for now just notice that available item icons (buttons) include its lock and mute status, its FX chain, its notes and properties.

If you enable the option **Draw labels above the item rather than within the item** then the buttons will be displayed (with the item name) above the item. You can, however, also

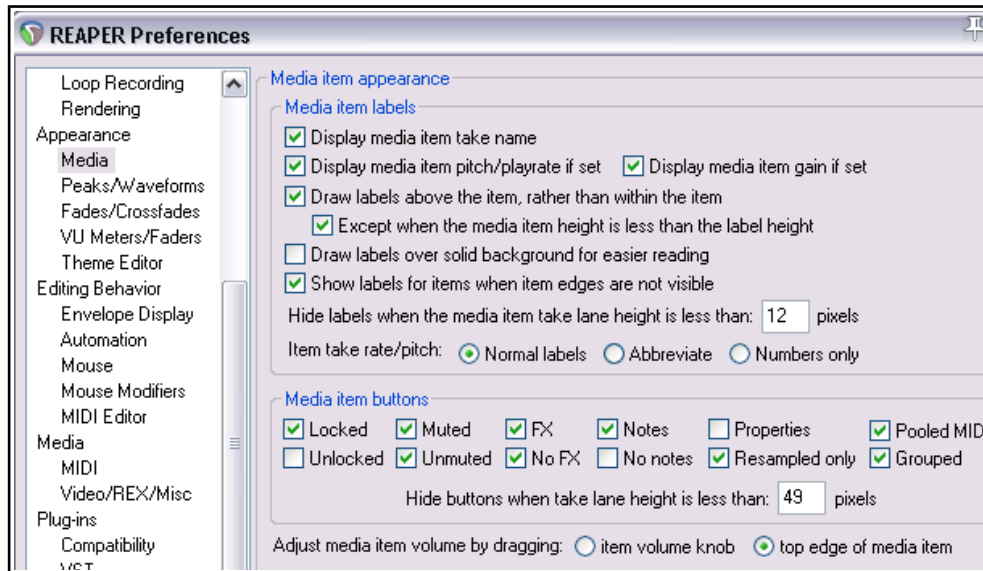

specify as an exception that **When media item height is less than label height** the label should be moved to inside the media item. If you disable these options, the labels (if displayed) will always be superimposed on the media item itself.

7.11 The Nudge/Set Items Window

The **Nudge/set items** window can be opened from the media items right-click context menu. You can use the Actions List editor to assign this action to a keyboard shortcut, or the Customize Menus/Toolbars editor to assign it to a toolbar. The use of both the Actions List editor and the Customize Menus/Toolbars editor is covered in Chapter 15.

Once opened, this window stays open until you close it. You can select any item (or a number of items) and use this window to nudge or set a position. Exactly how this behaves will at times depend on your other settings (for example, snap settings, and whether or not the item is loop enabled). The main options and parameters in this window are described in the table below, moving from left to right.

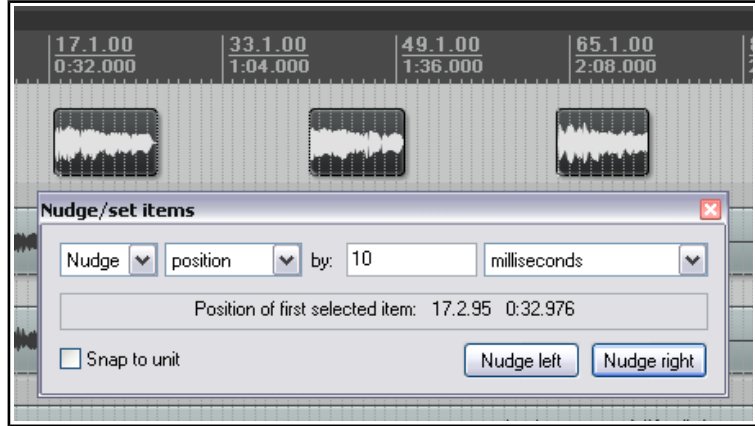

Item	Explanation
Action	Choose Nudge or Set . Which of these you choose will determine how REAPER will interpret the Unit information. If you choose Nudge, the item will be moved according to the unit specified <i>by</i> the amount specified. In the example shown above, the item position would be moved 10 ms to the left or right (depending on which Nudge button is clicked). If you choose Set, the item will be moved <i>to</i> the position specified.
Nudge/Set Definition	Determines exactly <i>what</i> will be nudged or set. Your choices are: Position Whole item: the whole item will be physically moved Left Trim The item is trimmed from the left Left Edge The left edge is moved Right Edge The right edge is moved Contents The item itself remains static, its contents are moved within it Duplicate Creates duplicate item(s) Edit Cursor Moves edit cursor Whether the movement is left or right will depend on which button is clicked. If Duplicate and Nudge are selected, you will be able to specify number of copies.
Unit Value	Determines the number of units by which the item will be nudged. This information needs to be interpreted together with the Unit Type selection. In the example shown above, the unit type is milliseconds and the unit value is 10.
Unit Type	Options include milliseconds, seconds, grid units, measures/beats, samples, frames, pixels, item lengths, item selections and notes. If notes is selected, an additional drop down list offering various fractions of a note (from 1/256 to whole) is also displayed.
Snap to Unit	Whether to enable or disable snapping.
Nudge Left Nudge Right	These buttons are displayed only if Nudge is selected. They determine whether to nudge the item(s) to the left or to the right.
Get Cursor Apply Move	These buttons are only displayed when Set is selected. Get Cursor returns the current cursor position and writes it in the "to:" box. Apply Move moves the item according to the various options and settings, including the position specified in the "to:" box.

7.12 Media Item Properties

All media items have a page of property settings which help determine the behavior of that item. Often, editing in REAPER consists of selecting an existing item (or creating a new one) and then changing its properties.

To display an item's properties, select it then press **F2**, or right click and choose **Item Properties**, or click on its properties button (if visible). For audio (but not MIDI) items, you can also double-click on the item to do this. The Media Item Properties box will stay open until you close it. If you leave it open, its contents will reflect the properties of whichever item or items is/are currently selected at any time.

You don't need to understand every single one of these properties before you get started, just to know where this information is accessed and changed. The main properties contained within this dialog box are:

- **Position:** entering a precise figure here will move the start of this media item to that position.
- **Length** of media item (Position and Length can be shown in **time, beats** or **HMSF**).
- **Fade In** and **Fade Out:** you can define both the length and the shape of these.
- **Snap offset:** The amount of offset from the default snap position if snapping is enabled.
- **Item timebase:** Defaults to project timebase but can be changed (time, beats, etc.).
- **Item mix:** Effectively whether to replace or mix when an item is placed over another. Defaults to project default.
- **Loop source:** whether item is a loop.
- **Mute status:** whether or not the item is muted.
- **Item lock status:** whether or not the item is locked.
- Whether or not to apply **autofades** at item start and end.
- Whether or not to **play all takes**. Obviously, this only applies where two or more takes exist.
- **Active take** file name.
- **Active take name.** By default REAPER will use the media item file name, but you can change this.
- **Pitch** adjustment.
- **Start in source:** sets start time.
- **Playback rate.** For example, type **x2** to double the playback rate of all items currently selected.
- Whether to **preserve item pitch** when the playback rate is changed.
- Adjust **Volume** and **Pan, Normalize**.
- **Channel mode:** this is discussed shortly.
- Whether to **invert phase**.
- Add or remove **Take envelopes**.
- Which algorithm is to be used for **pitch shift** and **time stretch**.
- **Stretch marker** default **fade size** and whether to optimize for **tonal content**.
- The option to use only a **section** of the media item.
- Options to **reverse** the item.
- Examine the media item source file's **properties**.
- Choose a **new file** to replace the existing source file.
- **Rename** the source file.

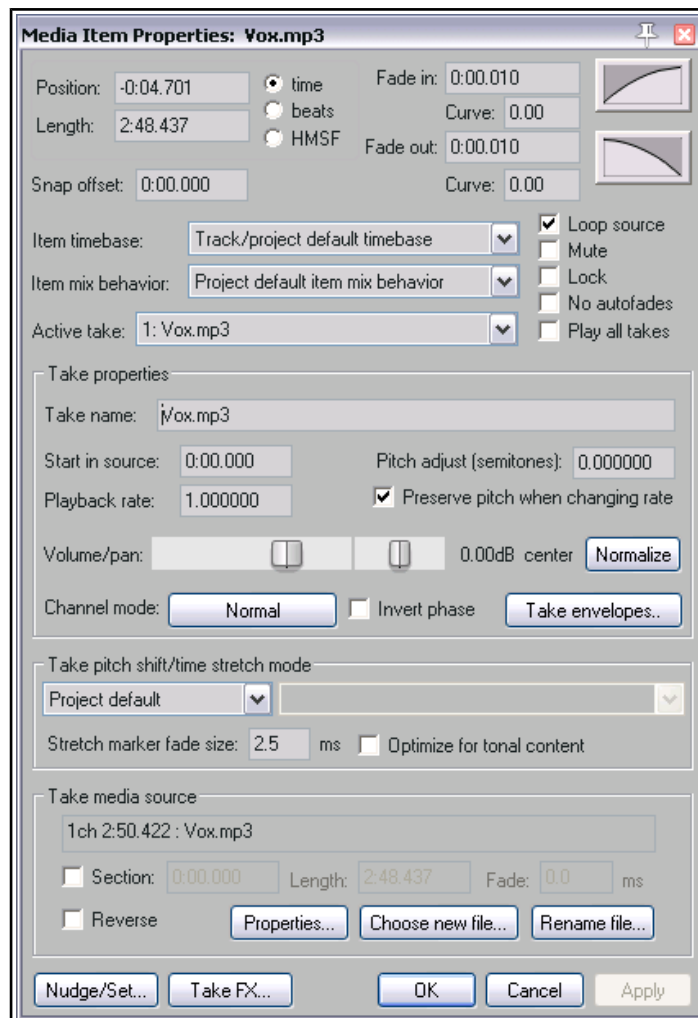

- Access the **Nudge/Set** dialog box for this item.
- Open the **Take FX Chain** window for this take/item.

After making any changes, use the **Apply** button to apply them and leave the window open, or **OK** to apply them and close the window, or **Cancel** to close the window without applying changes. There is also an option (right-click on title bar) to **Apply changes after 2 seconds of inactivity** that you can enable if you wish.

Some of these options – such as **Loop Source** and **Channel Mode** – are also available on the **Item Settings** menu. In addition, for many of them Keyboard Shortcuts either already exist or can be defined. You will be shown how to create your own keyboard shortcuts in Chapter 15 when we examine the **Actions List Editor**.

Tip: To change a property (e.g. playback rate) of several items at once, simply select all of the items then, with the Media Properties window open, make whatever changes you require.

7.13 Media Item Icons

For several of the settings in the Item Properties dialog box there are icons (buttons) available that can be used as a quick way of accessing these commonly used features. The display of buttons is turned on and off in the **Appearance, Media** page of the **Preferences** settings.

The icons are listed in two rows. Ticking options in the first row means that the icons will be displayed only when the item has been enabled (by a keyboard shortcut, the menu, or the Item Properties dialog box). Ticking options in the second row means that the icons will be displayed whether the feature is enabled or not.

For example, if you tick the **Mute** option in the first row but not the **Not muted** option in the second, then the mute button will be displayed only when the item is muted. The button indicates the track's mute status and can also be used to unmute it.

If you choose to tick this item in both rows then the mute button will always be displayed (provided there is sufficient room) on all media items, and can be used as a toggle.

Enabling **Properties (resampled only)** means that this button will only be displayed if an item is resampled.

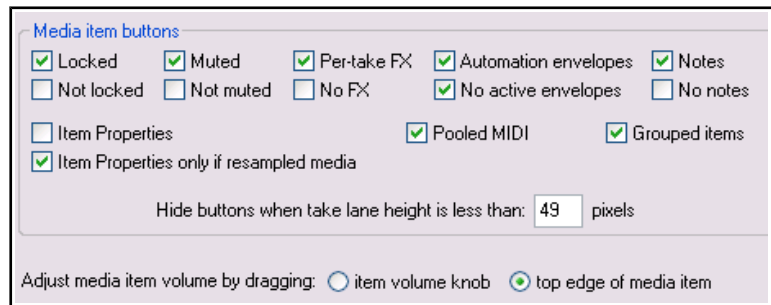

In the example shown (left) we have two media items, both with lock status, notes, mute and FX buttons displayed. The first item is muted and the second item is locked.

Whether your icons are displayed above the media items or superimposed upon the media items will depend on your preference setting

(on the same preferences page) for the option **Draw labels above item rather than within item**. Note that even if you have this option enabled, it will only be applied if there is sufficient track height. You'll find more information about other settings on this **Appearance, Media** page in Chapter 22.

7.14 Item Notes

The Notes button (or the **Item settings, Item notes ...** command from the right-click menu) can be used to open a text box that can be used to enter any text notes for that item. When notes have been entered, a small Notes icon will appear on the item. Hovering the mouse over this icon will cause the notes to be displayed as a tool tip. Click on the icon to open and edit the Notes window.

Within the **Notes** window, click on the **Load** button to load any .PNG or .JPG image file. The option **Use as item background** can be selected to display that image with the icon. Optionally, you may also choose to **Stretch to fit item**. An example of a media item displaying an image is shown here. Icons can also be inserted into media items by dragging and dropping from Explorer/Finder.



7.15 Coloring Individual Items

You can change the colors of individual media items (or selections of media items) by first selecting the items and then displaying their context menu and choosing **Item and take colors**, then **Set items to custom color** or **Set items to random colors** or **Set items to one random color**.

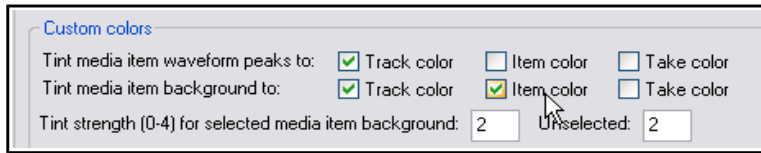

Various options to tint media item waveform peaks and/or backgrounds with **Item colors** can be found on the **Appearance, Peaks/Waveforms** page of your preferences (see above).

Some themes (including the default) disable user control of these options, in which case you will not be able to change them. One way to make these options available would be to use a different theme (see Chapter 11).

Examples

In the example below, our vocal track is split into several individual items. Suppose that these include two verses and two choruses, and that we wish to easily identify the choruses. We can select the chorus items, then right-click over any item in the selection and choose **Item and take colors**, **Set items to custom color** from the menu. (These commands are also available on the main **Edit** menu). We can then select any color we wish from the **Colors** dialog box and click on **OK**. These items are now shown in the selected color.



Other similar commands include **Set items to random color** and **Set items to one random color**. To remove a custom color, choose **Set items to default color**.

7.16 Adjusting Item Volume

Besides using envelopes (which we'll get to in Chapter 18) there are three main methods available to adjust the volume of individual media items. They are:

- Using either the item volume handle or the item volume knob.
- Using the volume fader in the Item Properties box.
- Normalization.

7.16.1 The Item Volume Knob/Item Volume Handle

The **Appearance, Media** page of your **Preferences** settings includes the option to use either an **Item volume knob** or **Top edge of media item** (item volume handle) as a quick and easy way to adjust the volume of individual media items.

The **Item volume knob** is shown here (right). Click and drag on this, up or down to increase or decrease item volume. Double-click to reset to 0.0dB. To adjust several items at once, select the required items then adjust the knob on any one within the selection.

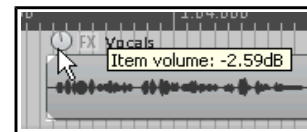

The **Item volume handle** is a horizontal bar that sits across the top of each of your media items. Initially it will not be visible until you hover your mouse over the top of the media item to reveal a double headed vertical arrow. You can click and drag with your mouse down to lower the volume level (see first illustration). To pick up the handle from the top of the media and increase the volume from there, hold down the **Shift** key while dragging (see second illustration).

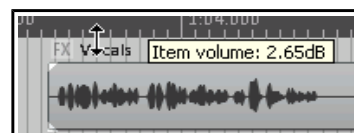
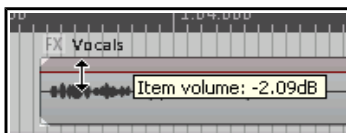

Use the **Control** key while adjusting either the item volume knob or handle for fine adjustments.

Tip: If you want the item volume handle when set to 0.0 dB to appear half way up your media items (rather than at the top edge), choose the **Options, Preferences** command, then on the **Media** page set **Media item adjustment range** to **-inf...+6 dB**.

7.16.2 The Volume and Pan Faders

The Item Properties dialog box includes two horizontal faders (Volume and Pan) to the left of the normalize button. These can be used to



raise or lower an item's volume and adjust panning. After setting the level, click on **Apply** to apply it to the item. This method is useful especially if you are making adjustments to both volume and pan settings together, or if you do not wish the item volume handle to be displayed.

7.16.3 Normalizing Items

The term *normalizing* refers to adjusting the volume of an item (or selection of items) to a standard level. This can be especially useful if some of your tracks have perhaps been recorded at too low a level. To do this:

1. Select any item (or group of items) to be normalized.
2. Right click over the selection.
3. Choose **Item processing** then either **Normalize items** or **Normalize items (common gain)** from the menu.

Use the **common gain** option if you want the level on all items to be raised by the same amount, or relative to each other. This will be the amount by which the loudest of the items can be increased without clipping.

If you want every selected item to be normalised independently do not select the common gain option. This can be expected to result in a greater increase in volume for some items than if common gain had been selected. Any individual item can also be normalised by clicking the **Normalize** button inside the Item Properties dialog box. This is especially useful if you need to make changes to other item properties while you are normalizing.

7.17 Changing Item Channel Mode

Right clicking over any Media Item and choosing **Item settings** from the context menu causes a sub-menu to be displayed. Notice in particular that for stereo media items, you have a number of **channel mode** options (also available in the Item Properties dialog box). These include:

- **Normal:** maintains or returns the stereo item to its original channel state.
- **Reverse Stereo:** swaps left and right channels.
- **Mono (Downmix):** combines both left and right channels into a single mono channel.
- **Mono (Left):** produces a single mono channel using only the output from the original left channel only.
- **Mono (Right):** produces a single mono channel using only the output from the original right channel only.

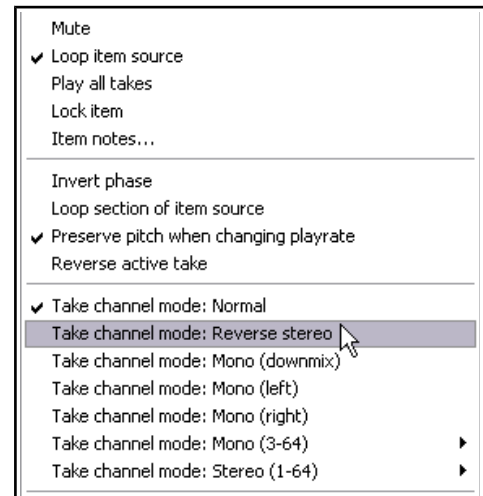

For multichannel items (see Chapter 3) you have also the option of mixing down in mono or stereo to channels other than 1 and 2.

Examples

Some examples are illustrated below. Note that these changes are non-destructive. You can switch an item between these different states as often as you wish. For example, to convert a stereo media item to two mono items quickly and easily, you can simply duplicate it, then set one to Mono (left) and the other to Mono (right)

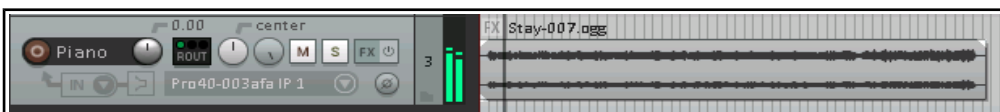

Mode: Normal

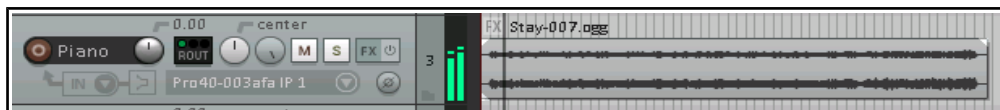

Mode: Reverse Stereo



Mode: Mono (Downmix) (i.e. mixed to as single mono track)

7.18 Take Source Properties

The **Take media source** section of the Media Item Properties dialog box can be used to view the properties of the currently selected take, or to change or rename its source file. Where the media item consists of only one take, then the terms “take media source” and “item media source” become synonymous. To change the media item contents click on **Choose New File**, or to rename it use the **Rename File** option.

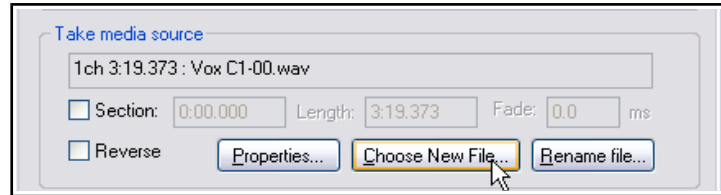

You can click on the **Properties** button to display information about the format of the original Audio file or MIDI recording which is the source of the item. In the case of MIDI items, you can also modify some properties, such as restricting which channels are played. Examples are shown below:

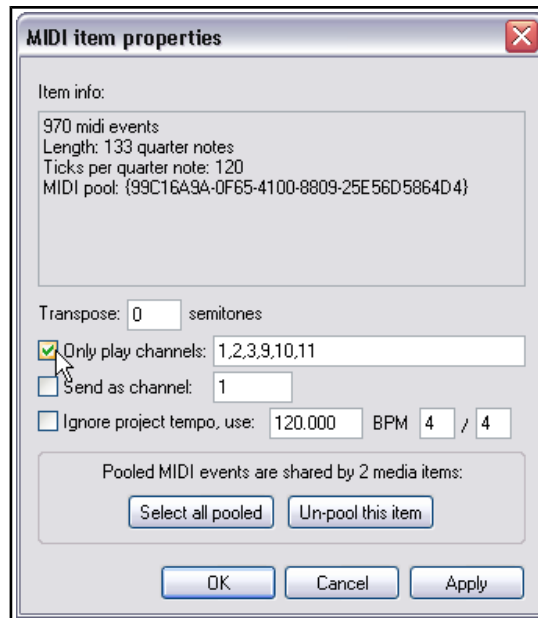
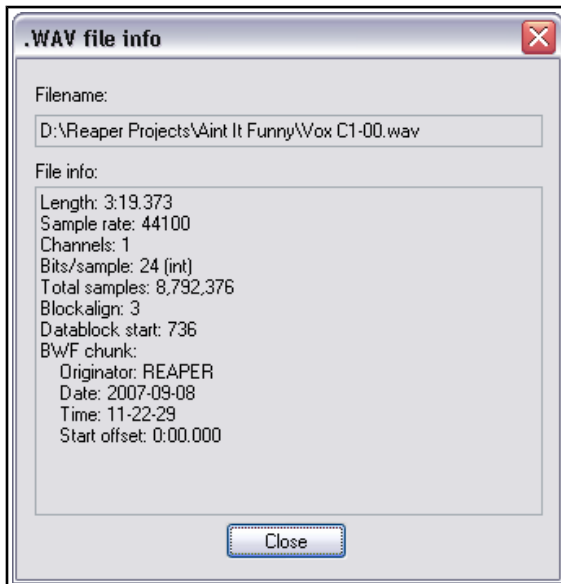

7.19 REAPER Editing and Auditioning Example

Most new users of any digital audio software struggle with editing at first, especially if they are used to another program which uses different techniques. The best way to understand what’s going on is to work thru some examples. These examples assume that you have the option to *Link loop points to time selection* enabled.

Open the file **All Through The Night.RPP**. Use the **File, Save Project As** command to save it as **All Through The Night EDITS.RPP**.

The examples that follow are designed to help you to learn and understand the use of REAPER. They are not intended to cover every possible feature – you can explore these for yourself – nor is it suggested that they represent a particularly good arrangement of this song.

By way of preparation, set pan the two guitar tracks 33% left and 33% right respectively.

7 - Editing Tracks and Items

1. We are going to make a copy of the Bouzouki track and then play around with the sound. In the Track Control Panel, right click over the Track name or number for this track, then from the menu choose **Duplicate tracks**.
2. Change the name of this new track to **Bouzouki Copy**. Press **Ctrl S** to resave the Project File.
3. In the Track Control Panel, click on the track number for the first Bouzouki Track then hold the **Ctrl** key and click on the track number for the second track. Both tracks are now selected.
4. Click on the **Solo** button for either track to solo both.
5. With both tracks still selected, use the mouse to lower the volume fader on either track to around -7dB - both tracks will be lowered. As you get near to the -7dB mark, hold the Ctrl key down for more precise movement.
6. Holding down the **Shift** key, move the Pan fader for the first Bouzouki Track to around 55% left, and, again holding the **Shift** key, move the Pan fader for the second Bouzouki track to around 55% right.
7. Right click over the Media item for the second Bouzouki Track. Choose **Item properties** from the menu. Change **Start in Source** to - **0:00.007**. Click on **Apply** then **OK**. This causes this item to be nudged 7 milliseconds to the right. This adds a very small delay effect to make the instrument sound fuller.
8. Press **Ctrl S**. Play the Song.
9. While it plays, hold down **Ctrl** and click on the **Solo** button for either of the Bouzouki tracks. This clears both the Solos.
10. Right click just beneath the **Track Control Panel** area and choose **Show master track**.
11. Adjust panning and volume for the various tracks to get a reasonable mix. You might end up with something similar to that shown above. Press **Ctrl S**.
12. In the example shown, you might be happy with the overall balance between the different tracks, yet the overall volume of the Master might be just a tad too loud in parts.
13. Open the **FX** bin for the Master and insert into it the **JS/Utility Limiter**. Set the maximum volume of the limiter to -0.5. Close the FX window, and make sure the Volume Fader for the Master is set to 0dB. You can now play the song without clipping.
14. Notice there is an extended period at the end of the song that we might wish to remove. Position the Play Cursor at around the position shown (right). Make sure that no track is selected, then press the letter **S** to split all tracks at the cursor mark.
15. Note that whereas before each track consisted of one item, each now has two items. The items (to the right) that you have just created by splitting should still be selected (as shown here). If they are not, right-click and drag over them to marquee (select) them.
16. Press **Delete** to remove these items. Press **Ctrl S** to save.
17. Now we're going to mute *part* of an item. We first need to make a separate item containing just the area to be muted.
18. Select the media item for the **Vox** track. Position the Edit Cursor round about the 56 second mark.

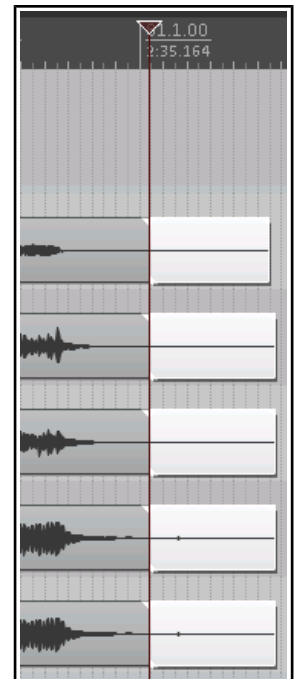

Up and Running: A REAPER User Guide v 5.24

19. Press the **~** key (**Shift `**) to maximise the current track. Press **Ctrl Alt Up** or **Ctrl Alt Down** until the **Vox** track is displayed. At this level of magnification you can see that some unwanted sounds have been recorded during a passage when the singer is not singing. As likely as not, this is probably headphone bleed. We're going to get rid of it.
20. If you want to hear it first, you can **Solo** that track and play it. Don't forget to **Unsolo** when finished.

21. View the **Big Clock**.

With the edit cursor near the 56 second mark, repeatedly press the **+** key, until the area we want to deal with occupies a large part of the screen.

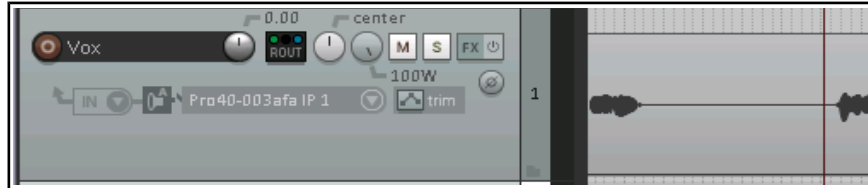

22. Click once on the media item to select it.
23. Click and drag just below the timeline to select the region that we wish to work with (see below).
24. Right click over the media item and choose the command **Split items at time selection**. This creates a new item, and this new item is still selected. Press **Esc** to clear the time selection.

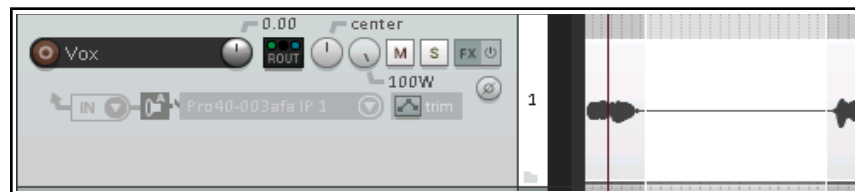

25. If the item's mute button is visible, click it. Otherwise, right click on this new item and choose **Item settings** then **Mute**.
26. Press the **~** key to return the whole of your song to the display. Adjust track heights as you wish.
27. Play the song. Notice that the **Vox** track is now muted during the passage that we have been working on.

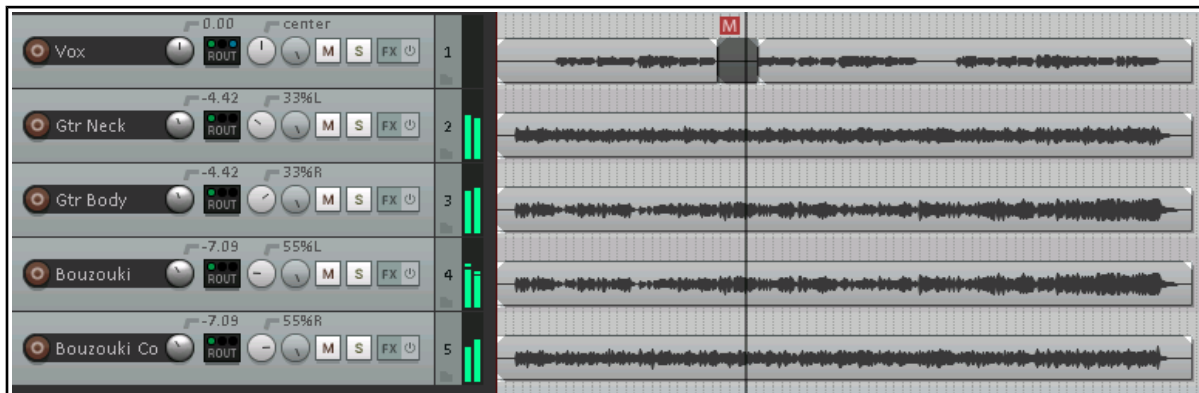

28. Press **Ctrl S** to save. We'll be returning to this example shortly.

7.20 Editing Multiple Media Items

You can use REAPER's various item editing and manipulation techniques (including smart editing) on selections of multiple items. Just make your item selection and then carry out the required action (delete or move, etc).

1. You can do this with more than one adjacent track at a time by using the marquee method (right-click and drag) when making a selection.
2. You can also do this for media items in non-adjacent tracks. Make the time selection, then select the first item, then hold **Ctrl** while you click on each of the other items. In the first picture (right), tracks 1 and 4 have had an area

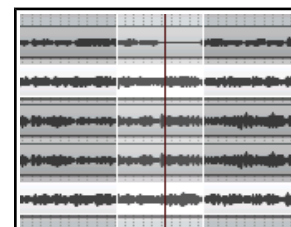

selected in this way. In the second screen shot (below), the same selected area has been cut from both media items.

This is an example of where you may wish to customize REAPER's mouse settings to change its default behavior. For example, you might wish to ensure that even when multiple items are selected, only the one item is edited. This can be done on the **Mouse Modifiers** page of your **Preferences** window, a topic covered in Chapter 15.

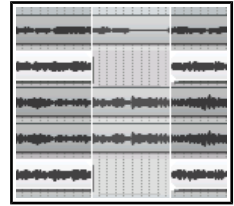

7.21 Slip Editing

You can slip-edit unwanted passages from the start or end of a media item by following this sequence:

- Hover your mouse over the lower part of an item's left or right edge so that the mouse appears as a double headed horizontal arrow with a square bracket (as shown right). The direction faced by the bracket will depend on whether you are at the start of the item or the end.
- Click and drag to the right or left (as appropriate), then release the mouse.

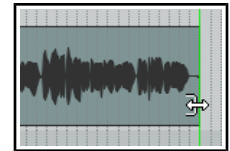
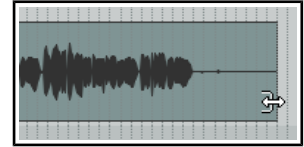

Slip Editing Multiple Items

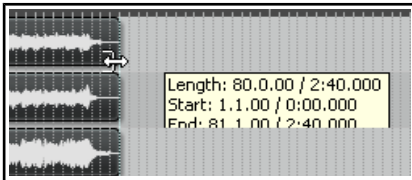

To slip edit several items in different tracks, simply select all the media items required (for example, hold the **Ctrl** key while clicking in turn on each item, or use the marquee method), then slip edit any item in the selection. The change will be applied to all items in the selection (see left).

This is another example of where you may wish to customize REAPER's mouse settings to change its default behavior. For example, you might wish to ensure that even when multiple items are selected, only the one item is slip edited. This can be done on the **Mouse Modifiers** page of your **Preferences** window. This topic is covered in Chapter 15.

Take care when slip-editing adjacent items, especially when they are touching each other. If you click and drag on one of the items so as to create a space between the two, then slip editing will take place in the usual way. However, if you slip edit in such a way as to overlap the items, you will create a crossfade. Both items will be heard when the overlapping portion is played.

This is illustrated here, where the end of the first (further left) of the two adjacent items has been slip-edited to the right, overlapping the other item. This behavior can be modified in two ways. Disabling auto-crossfade (on the toolbar) will stop the crossfade, but both items will still be heard.

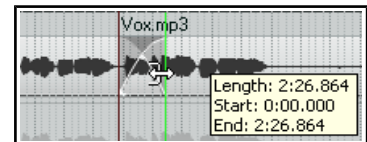

Enabling **Trim content behind media items when editing (Options)** menu) will ensure that only the slip-edited item (the item on top) will be heard during the overlap.

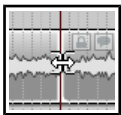

Another technique is to use slip-editing to move the boundary between two adjacent items (perhaps when an original item has been split). Select both items and hover your mouse over the boundary between the items to see the symbol shown here. You can then click and drag left or right to move the boundary.

7.22 Adjusting Fades

If you select any item in a track and zoom in close enough, you will see that there is a fadeout curve at the end of that item. You can change both the shape and duration of this curve, either using the mouse, or thru the **Item Properties** dialog box.

1. Select the rightmost item on one or more tracks. In the example shown (right) two tracks have been selected. In this example the items selected are vertically aligned: this does not need to be the case.
2. Hover your mouse over the vertical white line that marks the start of the fade. The mouse changes to display a curved shape.

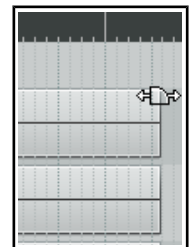

3. Click and hold down the mouse button. Drag left to increase the length of the fadeout (see below left) then release the mouse. Notice that the fadeout curve is now more gradual. If you were to slip edit any or all of these items, the fadeout would keep its shape and duration – it would just begin sooner.

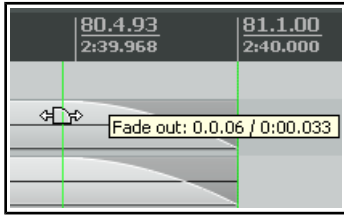

4. Make sure that your media items are still selected.
5. Right-click over the vertical line that marks the start of the fadeout. A menu of different fade curves will be displayed (see right). You can select any of these.

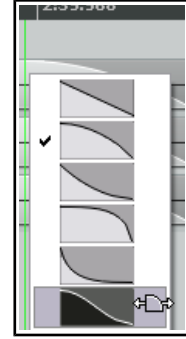

If you prefer, instead of using your mouse, you can press **F2** (with the items selected) to display the Items Properties dialog box. You can make your changes there.

Notice that your REAPER **Options, Preferences** dialog box includes an area on the **Project Defaults** screen where you can specify default fade and crossfade length, overlap, and shape characteristics. See Chapter 22 for further information.

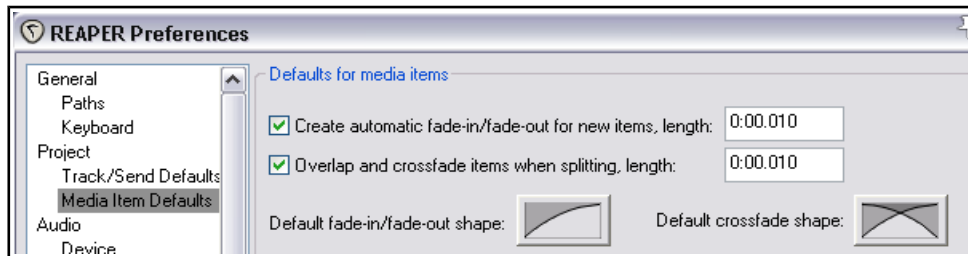

In addition, the Preferences **Mouse Modifiers** page gives you additional functionality by using modifier keys with your mouse when working with fades and crossfades.

For example, holding **Shift** while dragging the mouse left or right will move a crossfade left or right. Other default settings are shown here, but you can change them. For information about customizing your mouse modifiers, see Chapter 15.

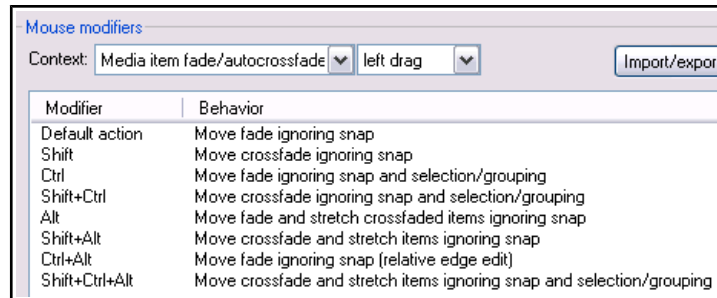

7.23 Crossfades and the Crossfade Editor

Typically a crossfade might be used to transition gradually from one media item on a track to another. In the example shown (right), two media items overlap each other with a crossfade. **Alt X** toggles on and off auto crossfade mode.

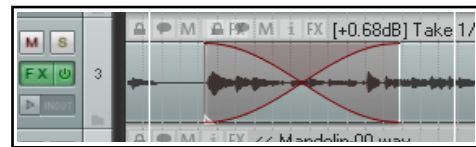

When enabled, this ensures that dragging the start of one media item over the end of another will automatically create a crossfade. Default crossfade parameters (including **fade and crossfade shapes**) are set in the **Media Item Defaults** page of REAPER's preferences.

Various crossfade elements (such as shape, start and finish) can be edited with your mouse in much the same way as you might edit a simple fade. In many cases this might be all you need to do. However, if you need it the Crossfade Editor gives you more precise control over the shape and sound of the crossfade. The Crossfade Editor is opened using the **View, Crossfade Editor** command, or by double-clicking on a crossfade.

Below you can see the same crossfade as before, with the crossfade editor open. The crossfade area has been selected (by click anywhere on the crossfade curve). The crossfade editor displays the fade parameter information for the selected media items.

It might help to use a copy of your project at first, until you become familiar with how the controls work. The following should help you to understand the controls and options and how they can be used:

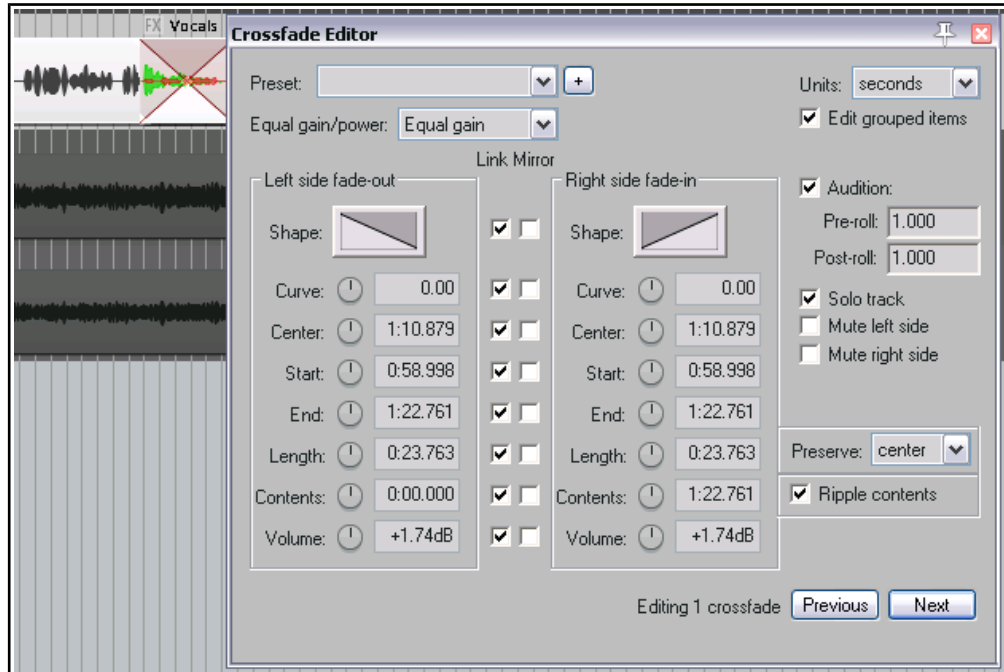

- ◆ The fader **units** (top right) can be set to your preference, either time (seconds) or beats.
- ◆ Any of the seven **shapes** shown can be selected for fade out, fade in, or both. After choosing a shape, you can use the mouse directly on the crossfaded media items. Drag left/right on either curve to adjust the fade itself, or at the intersection to move just the point where the fades cross. The dialog box controls can also be used to edit the fades and crossfade (see points below).
- ◆ Mouse modifiers can be used to customize mouse behavior (see next page).
- ◆ Optionally, you can select **Equal gain** or **Equal power**. **Equal gain** settings include linear fades (the top shape). **Equal power** includes logarithmic fades (second from top). Equal gain might be preferred when both items contain similar material. Equal power might be chosen when the crossfade is between two different types of sound or different instruments.
- ◆ Adjustable parameters are **curve**, **center** of crossfade, **start** and **end** locations of fade-out and fade-in, **length**, position of **contents** (the crossfade media items), and **volume** of fades. Most of these are self-explanatory. The **curve** setting will adjust the shape of the left, right or (if linked) both curves. Depending on other settings, this may cause the fades' intercept point to move left or right. Note also that when adjusting the **length** you can specify which position should be **preserved** – center, start, or end. The **contents** rotary can be used to move either of the media items left or right. The **volume control** can be used to adjust the volume of the crossfaded items.
- ◆ Parameter values can also be typed directly into the edit boxes.
- ◆ Left/right values of the different parameters can be **linked** or **mirrored**. Except for **start** and **end**, link and mirror are mutually exclusive options. For example, if **shape** is linked then changing the shape of either fade will cause both to be changed in the same way. If mirrored, selecting a shape for one fade will cause an opposite shape (if one is available) to be applied to the other fade. If **start** and **end** are linked and mirrored, then adjusting either of these controls will change the crossfade start and end length equally, keeping the center point constant. If **length** is linked, adjusting the length of either fade will change the length of both fades equally. If mirrored, lengthening one fade will cause the other to be shortened by an equal amount. If **contents** are linked, that control will move both media items left or right together. If mirrored, it will move them in opposite directions. If **volume** is linked, then adjusting either control will raise or lower the volume

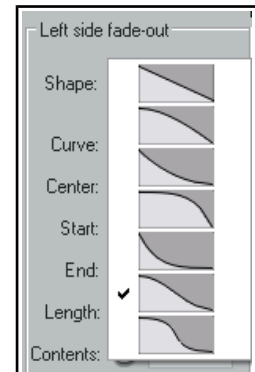

- of both items together. If mirrored, then raising the volume on one side will lower it on the other.
- ◆ You can choose whether your edits should apply to all **grouped items**.
- ◆ You can **set** the position of **audition** points before and after the crossfade. Enabling audition will cause the crossfaded area (together with the pre-roll and post-roll) to be looped when play on the mini toolbar is engaged. Any other existing loop settings in the project will be retained.
- ◆ There are also options to **solo** the track and **mute** either left or right side of the crossfade.
- ◆ Right-click over the Crossfade Editor for a context menu.
- ◆ The mini toolbar at the foot of the window can be used to **play**, **pause** and **stop** playback, and enable/disable **loop audition**.
- ◆ **Previous** and **Next** select the previous or next crossfade.
- ◆ The **+** button (top) can be used to save the current crossfade editor settings as a **Preset**. Optionally, you can include crossfade length within the preset. Saved presets can be recalled from the drop down list to the left of this button.
- ◆ If several crossfades are selected, the crossfade editor will by default apply its settings to the entire selection. For mouse edits, this can be changed in your mouse modifiers.

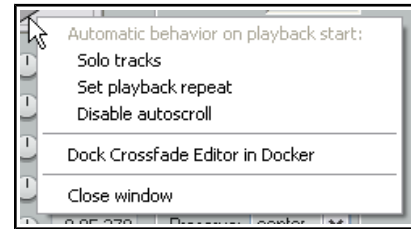

Fade/Crossfade Mouse Modifiers and Actions

Both media item fade intersection and fade/autocrossfade mouse modifiers (right) can be defined separately for left click, left drag and double click actions. In many cases the left drag modifiers are likely to be of most interest. These modifiers can be used when working with fades or crossfades, e.g., to enable or disable various options, (such as whether to ignore snap and/or selection/grouping, and whether to stretch items) or to assign actions (such as adjusting the fade curve).

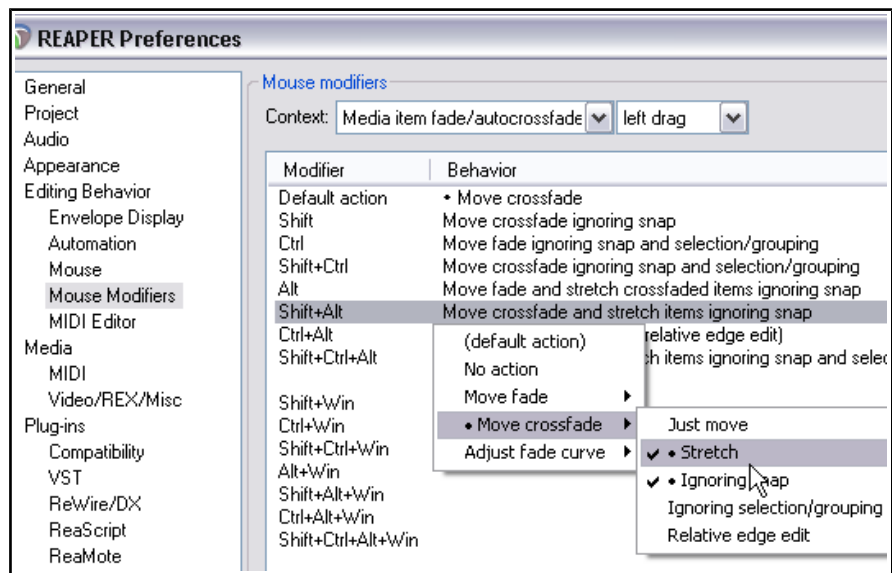

There are also options which enable you to adjust the fade curve with the mouse.

Left click and double click modifiers can be used to apply any of a number of additional fade intersection or auto crossfade actions from REAPER's Actions list. These include actions to change fade/crossfade shapes, to adjust curves horizontally only or both horizontally and vertically, and to adjust fade curves in various ways. Search the actions editor to see the full list. For more general information about using both mouse modifiers and the actions list see Chapter 15.

Note also that the **Appearance, Fades/Crossfades** page of your Preferences includes various options which determine how and when fade/crossfade edit handles are displayed (see Chapter 22).

7.24 Crop Project to Selection

When recording, it's not unusual to end up with a period of silence at the beginning, before your song actually starts, and varying periods of silence at the end of your various tracks, where you have perhaps allowed the recording to continue longer than necessary.

Of course, you can fix this by slip-editing your tracks individually, then dragging and dropping them to the start of your timeline. A quicker way would be to **Crop project to selection**. To crop a project to selection, do this:

1. Click and drag along the background area to mark the area that you want to keep – see picture below.

- Right click over the Timeline and choose **Crop project to selection** from the menu. If you wish, press **Esc** when this is done to remove the time selection.

Tip: If immediately after cropping to selection (and before pressing **Esc**) you again right click over the Timeline and choose **Zoom selection** from the context menu (or use the shortcut keys **Ctrl Numpad Plus** your project will expand horizontally to fit the width of your Track View window.

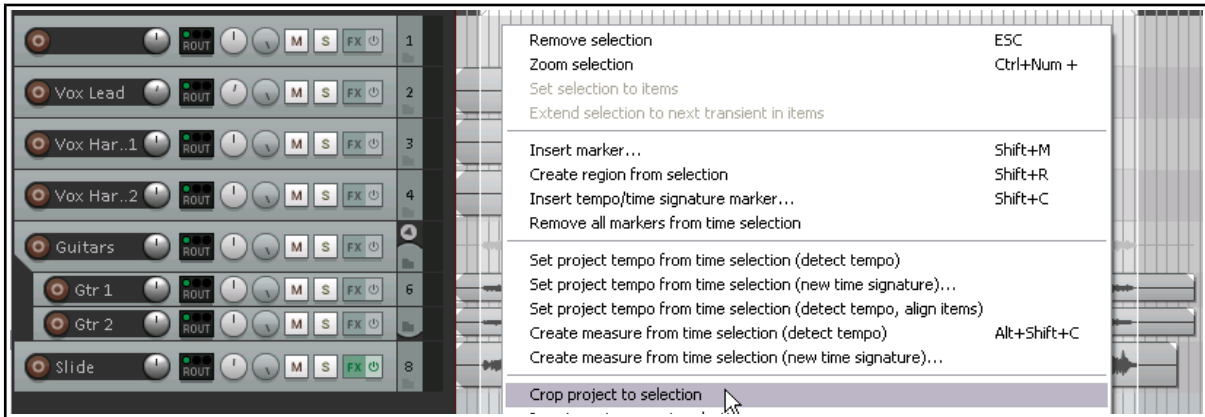

7.25 Grouping Items

Provided that Grouping is enabled – **Options, Item Grouping Enabled** command, or **Alt Shift G** – items can be grouped together to facilitate working with them. For example, you can move them together, set them all to a common color, mute and unmute them, and so on).

Select the items and use **G** to add them to a group. If you prefer, you can use the **Item grouping** button on the REAPER toolbar to toggle grouping on and off.



In the example shown below, three of the six items have been grouped. For grouped items a **Grouped** icon will be displayed if this has been enabled in **Preferences, Appearance, Media**. Even when this preference is disabled, you will see a thin colored bar above and below all items that have been grouped (see right).

Further items can be added to a group. Select any item in the group, then press **Ctrl G**



to select the entire group. Hold the **Ctrl** key while you click on those items that you wish to add to the group, then release Ctrl and press **G**. Note that **U** removes a selected item from a group. You can also use the **Group** commands on the right click item menu to manage groups.

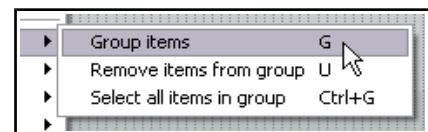

Example

Here is a simple example, using the file **All Through The Night EDITS.RPP** and save it as **All Through The Night GROUP ITEMS.RPP**

- Select the **Vox** track, and use the editing techniques that you have already learnt to cut this track into several media items, so that it resembles that shown above. There are a number of ways you can do this – one is to position the cursor at the point that you want to split, then select the item, then press **S**. Repeat this as often as necessary. To remove unwanted items, select them and press **Delete**.
- Check your **Options** menu to ensure that **Item Grouping** is enabled. If it isn't, turn it on. Notice that by default, the keyboard shortcut **Alt Shift G** can be used to toggle Item Grouping on and off.
- Select the second of the items in the Vox track. Hold down the **Ctrl** key while you select in turn the fourth and last items for this track.

Up and Running: A REAPER User Guide v 5.24

4. Press **G** to bind them into a group. Select any item in the group and press **Ctrl G** to select them all.
5. If item icons are visible, click on the **Mute** button for any item in the group. Otherwise, right-click and choose **Item Settings, Mute** from the menu. Repeat this to unmute them.
6. With all items in the group still selected, right-click on any of them and choose **Item and take colors** then **Set items to custom color**. Select a color and press **Enter**.
7. Now select the first of the items drag and drop to the right a little. All items in the group will move together. Press **Ctrl Z** to undo this.
8. Now click on any other media item not in the group. This deselects the group. Save the file.
9. Click again on any item in the group and press **Ctrl G**. Again, all group items are selected.
10. Press **U**. These items are now ungrouped. Save the file.

7.26 Storing and Recalling Item Groups

Different groups of items can be saved and recalled using the **Item Groups** tab of REAPER's Project Bay. The Project Bay will be explored in more detail in Chapter 12. For now, notice that you can open it using the **View, Project Media/FX Bay** command, and then select the **Item Groups** tab. To create and save multiple groups, simply use this method:

- ◆ Open the Project Bay and select the **Item Groups** tab.
- ◆ Select the items for your first group then right click over one of them and choose **Group** then **Group items** from the menu. A group will automatically be created in the Project Bay. You can right click over the group name and choose **Rename group** to give it your own name.
- ◆ Repeat this step to create subsequent groups. The example here shows a project with two item groups.

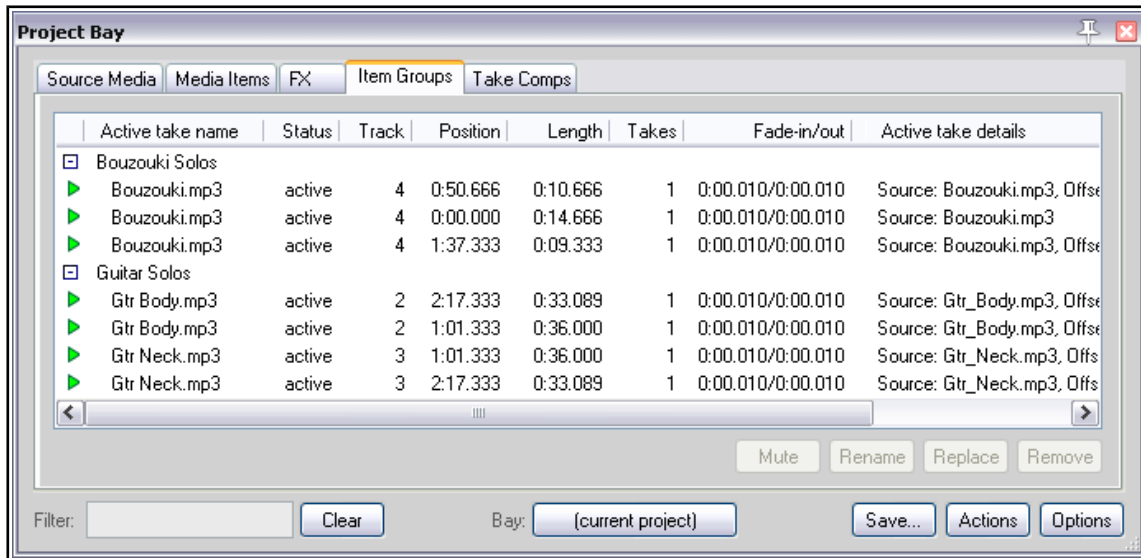

To select all items in a group, you can now right click over its group name in the project bay and choose **Select group** from the menu. To remove a group, use the **Delete group, keep items** command on the same menu.

Tip: To adjust the volume of all items in a selected group, hold **Ctrl** and **Alt** while adjusting the item volume button or item volume handle of any one of the items in that group.

7.27 Glue Selected Items

When you have a number of items in a track that you wish to permanently treat as one, you should consider using the **Glue items** command. When you glue items, they become one and a new media item is created. For example, two MIDI items glued together will automatically and always open together in the same MIDI Editor window. Two audio items glued together will now share one common set of Item properties. Items that have been glued together can be later split up any way you wish. This can be useful if you later realise that you need to adjust one or more properties of a portion of a glued item. To glue together a number of adjacent items in a track, follow this procedure:

1. Select all of the items that you wish to glue. The easiest way to do this is probably to right click and drag the mouse across the items.
2. Right click over any item in the selection and choose **Glue items** from the context menu.

Example

In the example shown below, a track is made up of six separate media items (as in the exercise above). By positioning the mouse initially over the first item, then right clicking and dragging to the last item before releasing the mouse, we ensure that all items are selected.

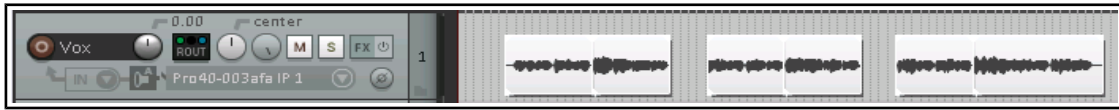

We then right click over any of these items (where the mouse is shown above) and choose **Glue selected items** from the menu. As a result, the items are joined into one, as shown below.



One application for gluing items is to join several items together into a new loop source. You'll learn more about working with loops in Chapter 9. Another use for glue is to render an item, for example, incorporating item gain and item take FX into the new media item and setting the FX to bypass. When a selection of two or more items are glued in this way, the FX and so on will be applied to the appropriate sections of the new item.

Note 1: When MIDI items are glued, any item that includes take FX such as a VSTi synth is rendered as audio.

Note 2: Actions are available in the Actions List (see Chapter 15) to ensure that when an item is glued, its channels will be increased if necessary to accommodate the output of any item FX. For example, if the action **Item: Glue items (auto increase channel count with take FX)** is applied to an item with FX which use two channels for output, then that item will be rendered in stereo (two channels) when glued.

7.28 Creating and Copying Items in Pencil Mode

REAPER includes an optional pencil mode that can be used to create new media items or make copies of existing ones. How the feature works is determined by your **Track left drag** settings on the **Mouse Modifiers** page of your **Preferences** window.

In Chapter 15 you will learn how to change these settings to suit your own custom requirements if you need to. For example, you could assign the **Shift** modifier to be used to draw a new item. For now, we will be looking at the default settings. These default settings are shown here.

Mouse modifiers	
Context:	Track left drag
Modifier	Behavior
Default action	Select time
Shift	Move time selection
Ctrl	Draw a copy of the selected media item
Shift+Ctrl	Draw a copy of the selected media item ignoring snap
Alt	
Shift+Alt	
Ctrl+Alt	Draw a copy of the selected media item, pooling MIDI source data
Shift+Ctrl+Alt	Draw a copy of the selected media item ignoring snap, pooling MIDI :

By default, the following modifiers can be used when clicking and dragging in an empty area in Arrange view:

- Ctrl** – draws a copy of currently selected media item. Snapping will be applied if enabled.
- Ctrl Shift** - draws a copy of currently selected media item, will not snap.
- Ctrl Alt** - draws a copy of currently selected media item pooling MIDI source data with snapping (if enabled).
- Shift Ctrl Alt** - draws a copy of currently selected media item pooling MIDI source data, will not snap.

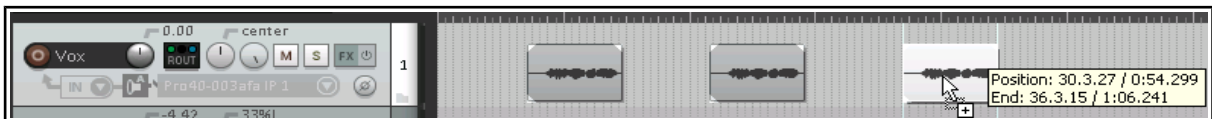

The illustration above is an example of this. The first of two existing media items on a track has been selected. By holding **Ctrl** while clicking and dragging further along that track, a copy of that media item is made.

7.29 Propagating Items

Two media item context menu commands, **Propagate item to similarly named items on track** and **Propagate item to similarly named items** (all tracks), can be used to copy the settings and features of one media item to other items on the same track and which share the same item name. Let's look at two examples:

Example 1

1. In this example, we have imported a sample into our project and placed it on a new track:

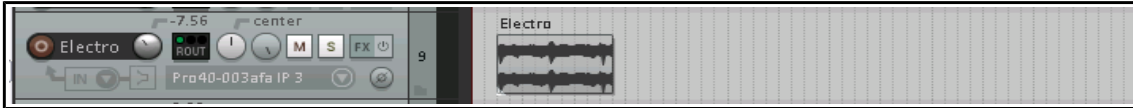

2. Next we have copied it as required across the track:

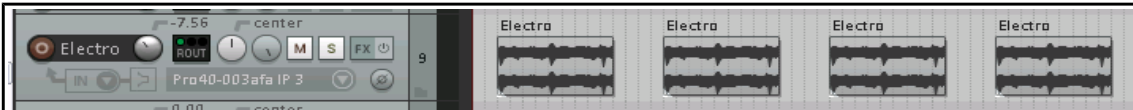

3. Some time later, we decide to make some edits to the first item. These include an adjustment to the item volume handle, some FX, and a fade out.



4. Finally, we right-click over this first item and choose **Item processing, Propagate item to similarly named items on track** to copy these edits to the other items. Any instances of this item on other tracks will not be affected.



Example 2

1. In this next example, the original item has been copied to create several media items across two tracks. Notice that each track has its individual settings, such as different panning and FX on one track but not the other. As well as this, the original media item has its own FX, volume envelope and pitch adjustment.



2. The **Item processing, Propagate item to similarly named items** command has been used copy the features of the original item to all other similarly named items in the project.



Tip: You can assign one name to several media items all in one go. Select all of the items, press **F2** to open the **Item Properties** dialog box, type the name in the take name edit box and click on **OK**.

7.30 Implode Items To One Track

Where you have built up a number of items that belong together but are spread across several tracks (as shown top right) you can select them all, right-click over any track in the selection and choose **Item processing, Implode items across tracks into items on one track**.

This will collect them together on to a single track (bottom right).

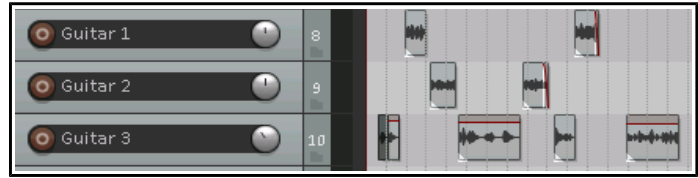

7.31 Insert Space in Selection

The command **Insert, Empty space in selection** can be used to create a gap anywhere in a song. Make your time selection before using this command. The space is applied to all tracks (as shown here).

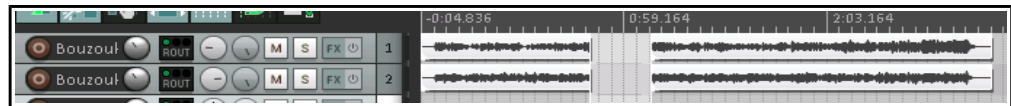
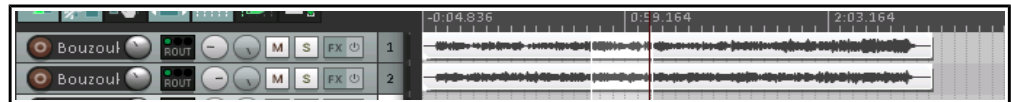

Existing material is moved to the right. You could then create additional material on any or all tracks in the space that you have opened out.

7.32 Ripple Editing

The simplest way to describe ripple editing is this: usually, when you delete part of a media item, a gap is left on the track where the deleted item used to be. With ripple editing, the material on the track is moved over to fill that gap. This is illustrated in the three screen shots below.



This first picture (left) shows a media item selected with a time selection highlighted.

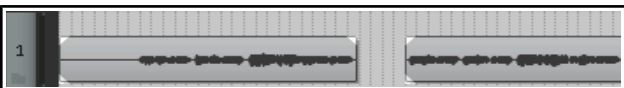

With ripple editing off, deleting the selected area of the selected media item has the effect shown here.



With per track ripple editing enabled, deleting the selected area of the selected media item has the effect shown here.

Two ripple editing options are available on the **Options** menu, or by right-clicking on the ripple edit button on the default toolbar. These are **Ripple edit per track** and **Ripple edit all tracks**. By default, both of these are off. Either one or the other (but not both at the same time) can be turned on from this menu.

Both off: This is the default mode. Items will not shift when you edit a track.

Ripple edit per track: If this is enabled, ripple editing will be applied when you are editing the currently selected track(s) but not to any other tracks.

Ripple edit all tracks: If this is enabled, all tracks will be subject to ripple editing. This means any editing you do to any of the items on any track will also be applied to all other tracks. This can be used, for example, for deleting entire sections of songs.

The keyboard shortcut **Alt P** can be used to cycle between the three ripple editing modes, as can the **Ripple Editing** button on the default toolbar. The right-click menu on this button also includes the options **Ripple edit all affects tempo map** and **Add edge points when ripple editing or inserting time**. By default both are disabled.

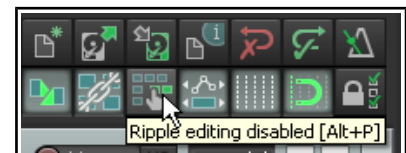

Up and Running: A REAPER User Guide v 5.24

In this mode, markers and automation are locked to the items that they relate to, so as you move items the associated markers and automation move too. Using this mode on multiple tracks is very useful for editing multitrack recordings of live material - everything that belongs together stays together in sync as you edit.

For instance, if you split the item at a couple of places (so you now have three items) then delete the middle piece, the remaining pieces join up, but unlike with a normal stereo editor, you can adjust the join by dragging the ends of the items appropriately. If you want to move material from one place to another, you can split at the insertion point, drag the material to the right of the insertion out of the way, then make the insertion and drag the displaced material to join it. All items to the right of the dragged item will stay together and markers and automation will move correctly too.

Here is shown an example with ripple editing on all tracks. Ripple Editing, all tracks is enabled. In the first picture the silence before the music starts is selected. The command **Cut selected area of items** is then applied. The selected area is cut from all tracks, and the remaining material is moved to the project start.

Note: Complications can arise if locked items are included in the selection that is to be ripple edited. In particular, REAPER needs to know whether the ripple editing should be applied to the locked items. The Editing Behavior preferences page includes options for dealing with this – see Chapter 22.

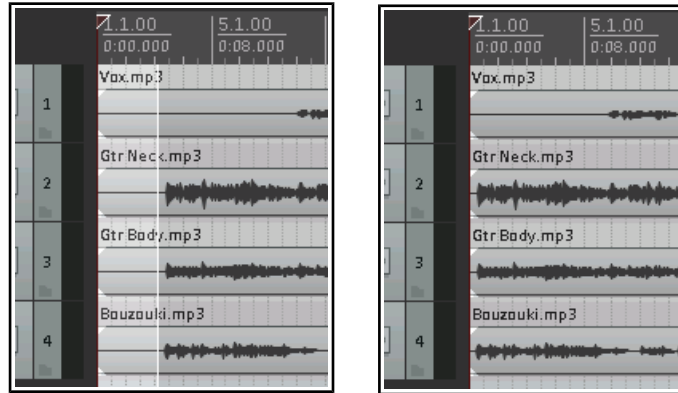

Tip: Shortly in this chapter you will be shown how to use **mouse modifiers** to determine how REAPER behaves when an item or selection of items is dragged. This includes options to select and apply any of the three ripple editing states when the item(s) is/are being dragged,

7.33 Trim to Selected Area

If you want to trim a media item or track from both the start and the finish at the same time you can do so. Just follow this sequence:

1. Select the media item (or items).
2. Click and drag in the track background area to select the area that you want to keep.
3. Right click over a selected media item and choose **Trim items to selected area**.

If **Ripple Editing** is turned on, the area that is trimmed will also be removed from the timeline, otherwise some empty space will be left. If your **Snap/Grid Settings** are set to include **Media Items**, then provided that snapping is enabled, snapping will be applied when you select the area to be trimmed.

7.34 Free Item Positioning

Choosing the option for **free item positioning** enables you to move your media items around freely within a track or tracks. This can be helpful, for example if you want two or more media items to play simultaneously or to overlap on the same track. To turn this feature on:

1. Select the track (or tracks) for which you wish to allow free item positioning.
2. Right click over the Track Control Panel and choose **Enable track free item positioning** from the context menu.

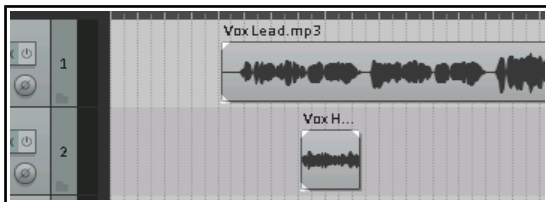

These illustrations demonstrate an example of how this feature might be used. In the first screen shot we have a Lead Vocal and a Harmony Vocal on different tracks. We might find it convenient to place these together on the same track.

In the second screen shot we have enabled Free Item Positioning for the Vox Main track. Notice that there is a small handle (shown by the mouse cursor) which can be used to adjust the height of this media item.

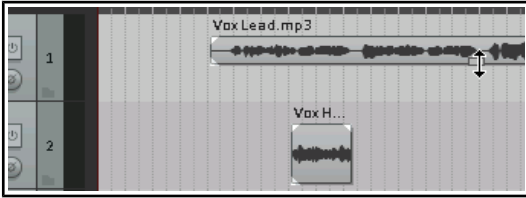

In the third screen shot (below) the media item for Vox Hmy has been dragged and dropped into the Vox Main track. When this track is played, both media items will play together. In fact, in this example, Track 3 can now be deleted.

Each item is

independent of the other. Either or both can be muted and unmuted, have FX added to them, have changes made to pitch and/or playback rate, and so on. You can use the **Media Item Properties** dialog box (**F2**) and/or the right-click context menu for this purpose.

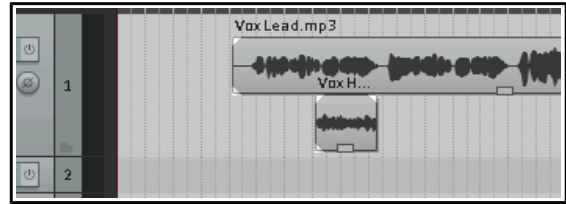

Tip: As you move items around in free item positioning mode you can sometimes find that items are placed on top of each other: this can make editing difficult. If this happens, select the items, right-click and choose **Item processing, Auto-reposition items in free item positioning mode**.

7.35 Mouse Modifiers

You have already encountered many examples of how REAPER uses the mouse with and without modifiers to perform a whole range of tasks. These have so far included making loop and time selections, copying and moving media items, slip editing media items, using item pencil mode, and so on. In Chapter 15, you'll learn more about how you can modify any of these if you wish, and even create your own. Meanwhile, you can find out more about the various Mouse Modifier default settings by browsing thru the **Editing Behavior, Mouse Modifier** section of your REAPER Preferences.

From the **Context** list, select a topic, such as Media item click, Media item edge drag, Track click, Ruler, click, Arrange view right-click, etc. A summary list of all default mouse actions relevant to that context will be shown. You can then double-click on any entry in the Modifier column to assign an action to that modifier.

Shown here (below) is an example of the default actions associated with the various mouse modifiers for when you are dragging media items. For example, by default, clicking and dragging a media item will move it, ignoring any time selection. Holding **Ctrl** as you do so will copy it – and so on.

There are many more for you to choose from. For example, you could define **Shift Win** as a modifier to restrict item movement to vertical only when moved or when copied. You could use **Ctrl Win** for adjusting an item's volume, and so on. To do either of these, you would need to double-click on the modifier in the list, then make your choice from the list of commands and actions offered.

The **Context** drop down list includes the following entries that can be relevant when you are working with media items.

Media item (left click, left drag and double-click)

Media item bottom half (left click, left drag and double-click)

Media item edge (left drag and double-click)

Media item fade/crossfade (left click, left drag and double-click)

Many contexts have an option associated with them: where present, this is displayed below the table, just above the **OK** button. In the example here, you have the option whether or not to treat the label area above the item as empty track space.

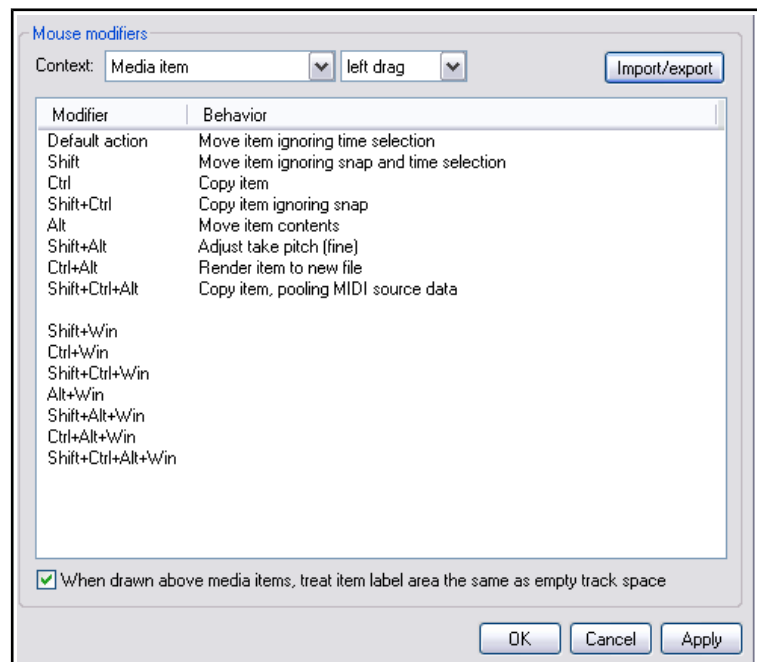

Up and Running: A REAPER User Guide v 5.24

Notice too the **Import/export** button. This can be used for saving and recalling your mouse modifier actions, either for the currently selected context or for all contexts.

There's a lot to explore here, and how you use these options will very much depend on your own personal needs. The examples that follow should help to get you started.

Media Item Left Click Modifiers

Shown here are the default mouse behaviors when you click on any media item.

Notice that the default behavior for a simple click is **Select item and move edit cursor**. On the other hand, **Alt Click** will select the item ignoring grouping.

If you wish, you can swap these assignments over, so that a simple click will select the media item without moving the edit cursor.

To do this, just double-click in the list on the item that you wish to change, then select your preference from the list (see right). You will find more information about customizing mouse modifiers in Chapter 15.

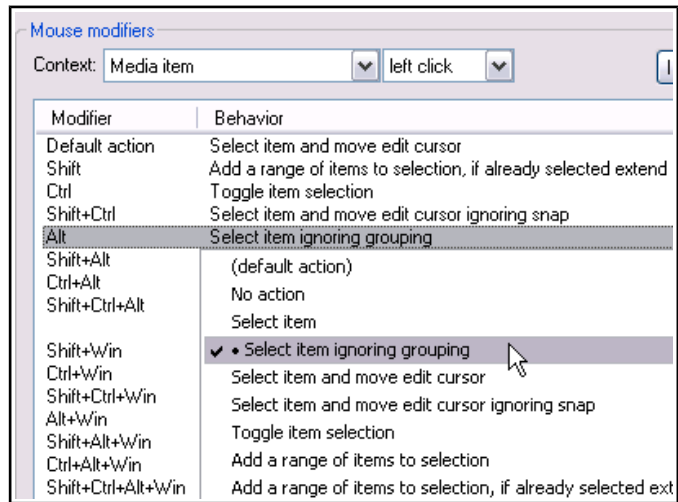

Media Item Edge Left Drag

Shown here (right) are the default mouse modifier settings that are used when clicking and dragging on the edge of any media item(s).

Chapter 15 includes a step by step example showing how you can change these.

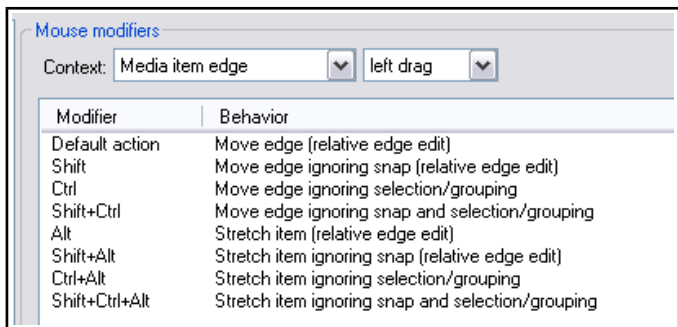

Other Options

Notice that you can assign different modifiers to be used when clicking on the bottom part of media items from those used when clicking on the top part.

In the example shown here, the default action for a simple click on the bottom half of a media item is being changed to **Toggle item selection**.

Note: When the context **Media item bottom half** is selected, an option is displayed to **Disable targeting of bottom part of media when take lane height is less than xx pixels**. By default this is set to 44. You will need to change this if you want to be able to use these context actions with media items less than 44 pixels high.

These are just some of the many possible examples of how you can use mouse modifiers in different contexts when editing media items. It's up to you now to explore the many other options for yourself, depending on which aspects and options are most important to you!

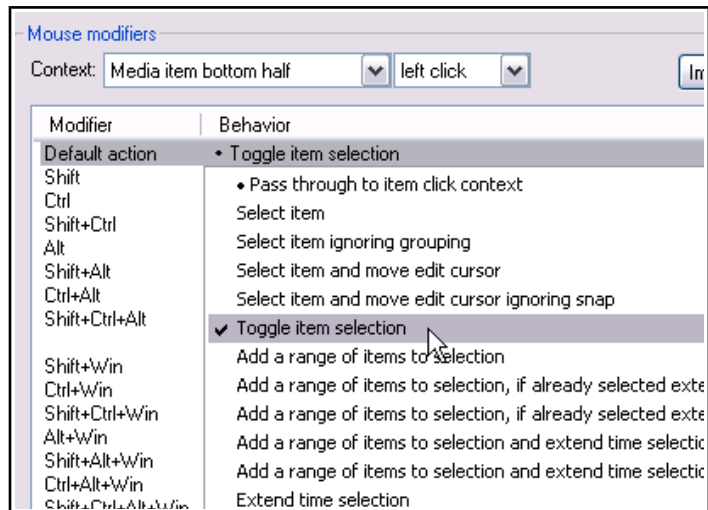

7.36 Dynamic Splitting - Remove Silent Passages

REAPER's Dynamic Splitting is a powerful feature which can be used for all sorts of purposes. Many of these are designed to help you with tempo based composition, but it has other more widespread applications. One such use is to clean up a track and remove those passages that should be silent. This can be handy, for example, with a vocal track, to automatically clean up the passages between verses which might contain unwanted background noises such as breathing or shuffling sounds.

Suppose that you have recorded such a vocal track. With dynamic splitting you can effectively tell REAPER to go thru the track and take out all of the passages where the vocalist isn't singing. These are the passages where you want the track to be silent and which otherwise might contain various breathing or other unwanted sounds.

To do this, you first select the media item then right click over it and choose the **Item processing, Dynamic split items...** command. You then need to select the required parameters before splitting.

You are given immediate visual feedback before executing the command. Each split point is indicated by a colored vertical line and those areas marked for removal are shown as darker. Dynamic splitting will be examined in more detail in Chapter 9, in the context of tempo based music production, but when applied to this particular task it can be used as explained in the table below.

Start with settings similar to those shown here and adjust then as necessary.

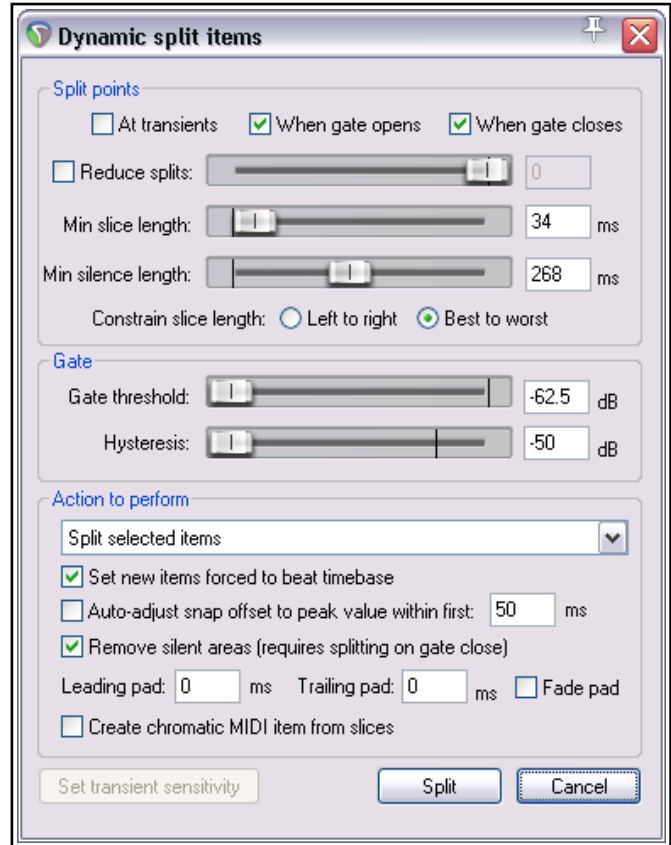

Summary of Dynamic Splitting Parameters

When used in this way, dynamic splitting basically employs a noise gate to tell REAPER how often and where to split your media items and which areas are to be removed.

Dynamic Split Parameter	Setting to Remove Silent Passages
At transients	Deselect this option when using dynamic splitting for this purpose.
When gate opens When gate closes	You would be unlikely to select one of these options without the other. Both of these options need to be turned on, so that REAPER can work out the beginning and end of each passage that is to be removed.
Reduce split	In most cases, when using dynamic splitting for this purpose this item should be deselected.
Min slice length	This sets the shortest length for any slice. You will probably need to experiment to get it right. Usually, this should be set to a low value. Happily, REAPER's dynamic splitting interface gives you immediate visual feedback. You can see by looking at the screen when your settings are right. The illustration below shows the effect of setting this value too high. Notice that it can result in some recorded passages also being removed

Up and Running: A REAPER User Guide v 5.24

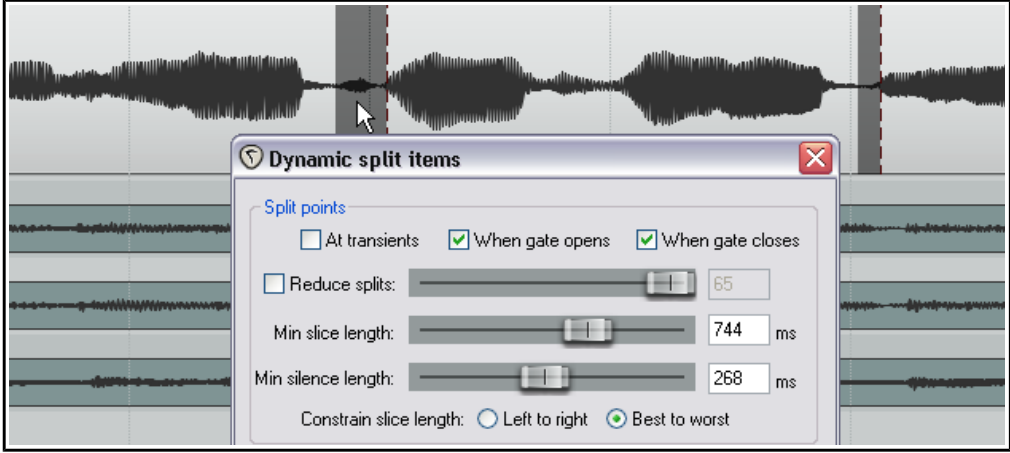
Dynamic Split Parameter	Setting to Remove Silent Passages
Constrain slice length	Options are left to right and best to worst . In many cases for this particular application this setting should not matter. If in doubt, try both and be guided by the visual feedback.
Gate threshold	This setting is important, but usually has a reasonable range of acceptable values. If made too low, unwanted sounds might pass thru the noise gate. If set too high, you risk deleting quieter passages of the recorded material. Start around -50dB and make any necessary adjustments from there.
	
Min silence length	This is another parameter that will require fine tuning. Set too high it will fail to catch all the periods of silence,
Hysteresis	This setting can be used to adjust the level at which the gate closes relative to that at which it opens. In the example shown above, the gate will close at -62.5 dB and reopen at -50 dB. Raising the hysteresis figure closer to or even above 0dB will have create more splits.
Action to perform	<p>For this application you would choose Split selected items or Split selected and grouped items. Other options are:</p> <p>Write stretch markers to selected items, or to selected items and grouped items: stretch markers are explained in Chapter10.</p> <p>Add transient guide markers to items: this option causes transients guide lines (vertical broken lines) to be added to the selected item(s), without the items being split.</p> <div data-bbox="789 1352 1383 1541" style="border: 1px solid black; padding: 5px;"> <p>Action to perform</p> <ul style="list-style-type: none"> Add transient guide markers to items Split selected items Split selected and grouped items Write stretch markers to selected items Write stretch markers to selected items and add to grouped items Add transient guide markers to items </div>
Remove silence	This option should be enabled.
Fade Pad	Enabling fade pad can help ensure a smoother transition.
Other settings	Leave them as shown here.

Note: Another method of removing silence is to use the **Auto trim/split items** action. This is essentially similar to the above method, but also includes some additional options. This is discussed later in this chapter.

7.37 Auto Trim/Split Items

REAPER's action list contains literally hundreds of commands and actions, many of which are not shown on any menus. Actions are covered in more depth in Chapter 15. Two actions worth looking at here are **Item: Auto trim/split items (remove silence)** and **Transient detection sensitivity/threshold (adjust)**. These two actions can work together. Actions are run by first choosing the **Actions, Show actions list** command from the main menu, then selecting the required action and clicking **Run**. Two points to note are that the Actions menu includes an option to **Show recent actions on menu**, and that within the Actions list you can use the **Filter** box to help find an action.

Auto trim/split items is similar to using dynamic splitting to remove silence, except that it supplies you with some additional options. Selecting an item and running this action opens the dialog box shown here.

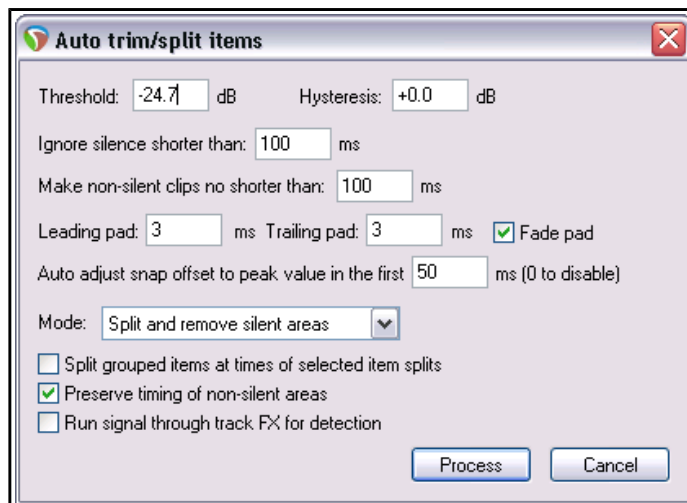

Threshold and **Hysteresis** control the noise gate to determine the level below which passages are removed, and the degree of sensitivity applied – the same as with dynamic splitting. Similarly, the controls **Ignore silence...**, **Make non-silent clips no shorter than...**, **Pad** controls and **Auto adjust snap...** all work in the same way as their equivalent dynamic splitting options.

The main item of interest is the **Mode** drop-down: this has four options – **Split and remove silent areas**, **Split and keep silent areas**, **Split only before non-silence** and **Split only before silence**.

If working with a selection of grouped items, you have the option to **Split grouped items at times of selected item splits**.

You can also set the gate to be applied post-FX by enabling the option **Run signal through track FX for detection**.

If you also run the action **Transient detection sensitivity/threshold** a pair of faint horizontal lines will be displayed to give you visual feedback on your gate settings (as shown, right).

Another useful option is to **Use zero crossings** when splitting. This can prevent audio clicks on playback.

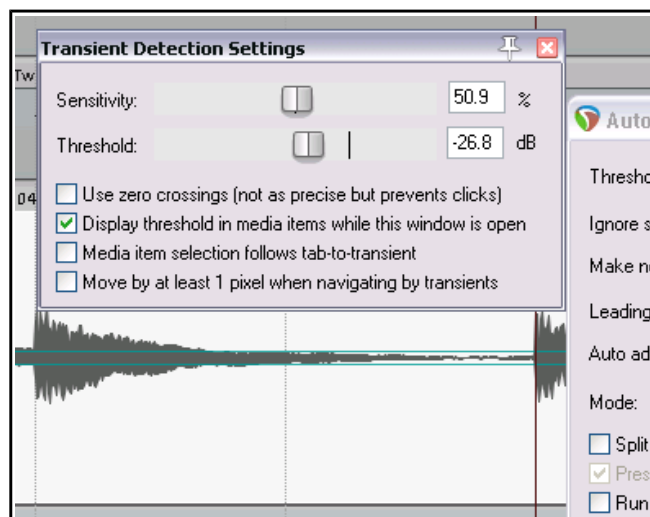

7.38 SWS Extensions

As you get to know REAPER better you will find that there are a number of editing and related actions that you will want to use frequently. This might include, for example, actions as diverse as lining up a number of media items with the edit cursor, or setting the volume of an entire selection of media items in one action. You will find that many of these actions – and more - are available as a plug-in to REAPER by downloading and installing the **SWS Extensions** Pack. To do this, you simply follow this sequence:

1. Go to <http://www.standingwaterstudios.com>
2. Follow the instructions to download the correct version for your operating system.
3. After downloading, run the install program, then start REAPER in the usual way.

The contents of this extension pack are by no means lightweight. They include not only hundreds of useful actions for editing and more but also whole modules which bring extra functionality to REAPER, including mixing snapshots and marker management. So comprehensive are they that they come with their own PDF manual.

8 Arranging, Comping and Editing Takes

Earlier, in chapter 3, we looked at how you can create multiple takes when you are recording. In particular, make sure you are familiar with the sections that cover **Showing Takes in Lanes**, **Using Color Coded Takes** and **Working With Multiple Takes**. The editing and arrangement techniques covered in Chapter 7 can also be applied to editing a project with multiple takes. This example is intended really to get you thinking about how you might approach the task. You have two main methods at your disposal. You can either:

- Explode the takes to new tracks. You can then work on and edit each track separately and (if you wish) join them all back to a single track when you have finished, *or*
- Work on and edit the various takes all within the single track on which they were recorded. We'll get to this method later in this section.

Note that unless specifically stated otherwise, the instructions in this section assume that you have the free item positioning option disabled for the tracks that you are working on. This is the default setting. (For more information about free item positioning, see chapter 3).

8.1 Using Item FX with Individual Takes

In Chapter 7 you learnt how FX can be added to individual media items. Where multiple takes exist on a track, each take can be assigned its own FX and FX chain. For example, you can insert separate FX plug-ins into individual takes, as shown in the example here. Select the required take, then press **Shift E** to open the take add FX window.

If you have enabled the options **Display media item take name** and **Draw labels above the item** (both under Appearance, Media, see above), then any FX chain for the currently selected take will be included in the information displayed. In the example shown on the right, Take 2 is currently active: the FX names displayed are those FX assigned to Take 2.

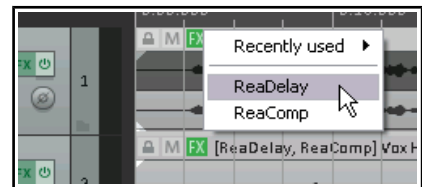

If you wish, you can insert the same FX into each take and apply different parameter settings for each one.

8.2 Exploding Takes to Multiple Tracks

We'll start by looking at the first of these two methods. Let's suppose that we have recorded three takes of a vocal track. We can right click over the item and use the **Take, Explode all takes to new tracks** command.

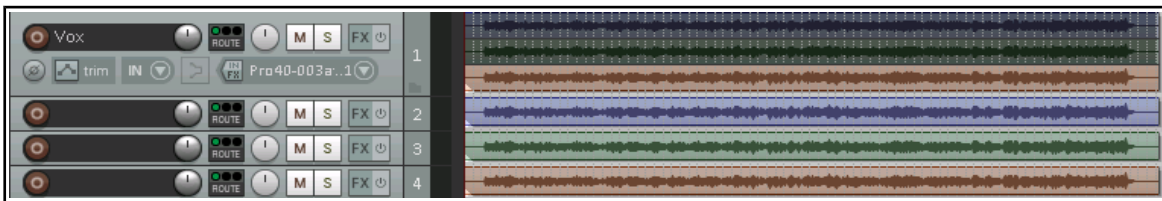

This command creates (in this case) three extra as yet unnamed tracks – the original track with its three takes is still intact. Now suppose that after auditioning we have decided which parts we want to use from each take. In the next illustration, we have edited the various takes to leave only the portion of each take that we wish to keep. This has been done using various editing techniques that have been covered in Chapter 7.

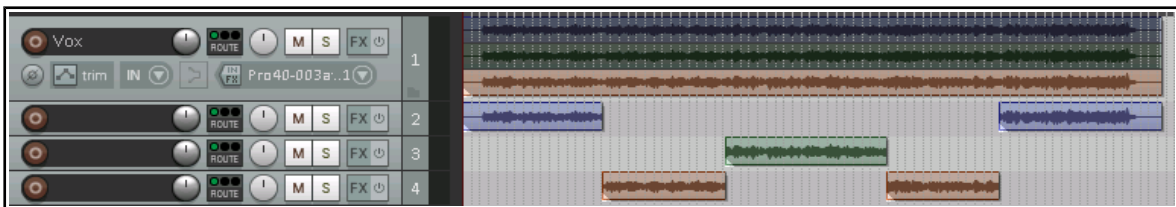

Finally, we select the various items from tracks 3 and 4 and use the **Num Lock 8** key to move them up to track 2. Track 1 is now muted and could of course be hidden. Tracks 3 and 4 could be deleted.

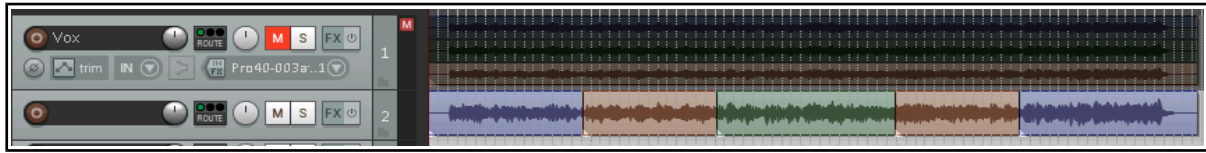

You could now select all of the items in track 2 and use the **Glue Items** command to bind them together as one media item. Note that the original muted track with the three takes on it is still available. This makes it easy at some later time for us to change our mind about what to include in the vocal track if we wish.

8.3 Crossfades with Takes

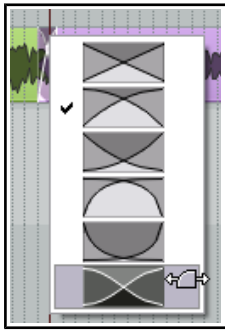

If you intend to arrange your media items so that they overlap, then you should first decide whether or not you want REAPER to add a crossfade. This feature is turned on and off using the **Auto Crossfade** button on the main toolbar (or the keyboard shortcut, **Alt X**).

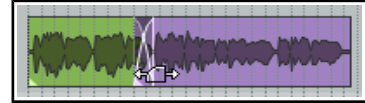

The curves of crossfades can be edited. You can extend the crossfade in either direction by dragging the vertical fade bars. If you hold **Shift** while doing this, you can move the crossfade itself left or right to a new position. Right-clicking over the crossfade reveals a menu of different crossfade shape options (see left).

Using these techniques can ensure that an otherwise abrupt edit is smoothly disguised by a gradual transition at the best edit point.

Various options are available to you for customizing mouse behavior when crossfade editing. These can be selected from the **Editing Behavior, Mouse Modifiers** page of your Preferences – see also Chapter 15. An example of this shown here. For more advanced crossfade editing, you might wish to use the Crossfade Editor (see Chapter 7)

8.4 Exploding Takes in Place

Another option is to use the **Take, Explode all takes (in place)** command. This has the effect of merging all takes on the track into a single lane. Here's an example of when you might wish to do this. The track shown here includes three lead vocal takes. You have made your selection of the best parts of each take. These have had their individual item properties (such as volume) adjusted to give you the sound that you want.

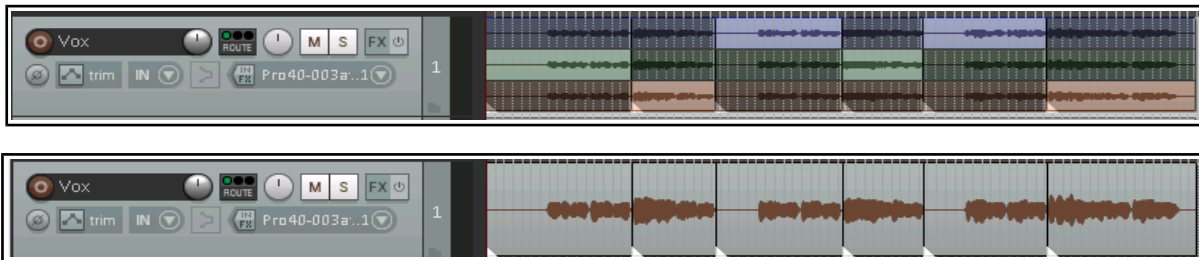

By exploding all takes in place, the selected items are placed over the others takes in a single lane, and are played together.

8.5 Play All Takes

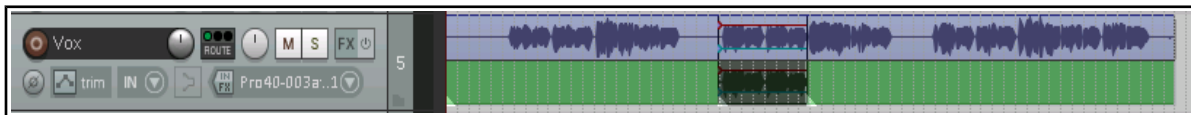

Here's a really interesting trick you can do with takes. Shown here is a vocal track with an overdubbed vocal harmony for just a short part. Both takes at that point have had individual pan and volume envelopes added, and some delay and perhaps pitch shift FX to the second take's FX chain.

8 - Arranging, Comping and Editing Takes

After selecting both these media items, right-click over either one of them and choose **Item settings** then **Play all takes**. We can thus have our complete vocal and harmony mix on one single track! This setting is also available from within the Item Properties window.

8.6 Editing and Comping Multiple Takes

You don't need to explode takes to multiple tracks in order to manage them. In this section we'll see some of the ways in which you can manage your takes all within a single track. In overview, this essentially consists of selecting the best parts of each take and comping them together into a single take of your preferred selections.

Slice and Dice

When you choose the **Option to Show all takes in lanes (when room)** there is a neat technique known as *slice and dice* that helps you combine the best of each take together, to play as one track. To do this, you simply **Split** the track in as many places (and at the exact points) that you think appropriate, then select from each slice your preferred section. The different methods that you can use for splitting are explained in Chapter 7.

A clever trick is to make all of the items that together make up a complete set of preferred takes a different color from the others. To do this, first choose your takes and select all of the media items (use marquee to do this), then choose from the right-click menu **Item and take colors**, then **Set active take to custom color** or **Set active take to one random color**. These commands are also available from the media item right-click context menu. An example of how this can be used is shown below.

Notice in this example that the second of these takes consists of an overdub of

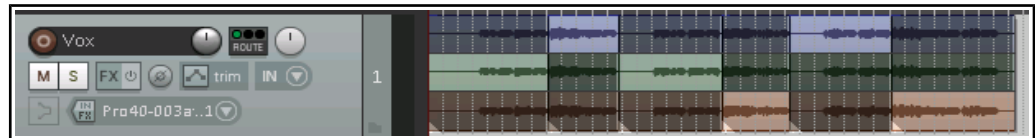

just a small portion of the song. The option to **Display empty take lanes (Options, Take lane behavior menu)** is enabled to ensure that your takes are displayed more clearly. An empty part of a take (such as exist in Take 2 here) cannot be selected unless you enable **Allow selecting empty take lanes (Options, Take lane behavior menu)**.

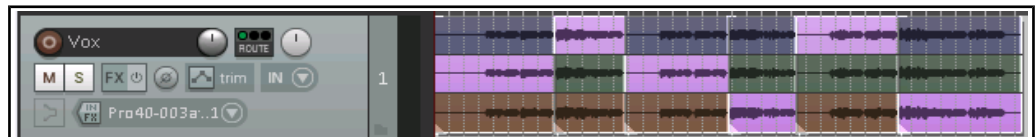

Note: If you prefer not to see the empty take lanes, you can hide them by disabling **Display empty take lanes (Options, Take lane behavior menu)**.

Comp Sets

You can save multiple comp sets for individual tracks (example shown above) and even for groups of tracks (as shown right). This latter example is a project with two vocal tracks, each of which has been sliced and diced and colored at random.

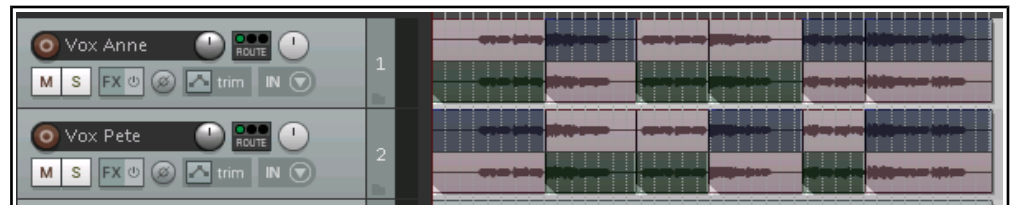

With all media items in this set selected (use marquee for this), you can right-click over the selection and choose **Comps** then **Save as new comp** from the context menu. You will be prompted for a name: this name will then be added to the Comps menu and can be used to recall this comp from the menu at any time. One advantage of this is that it makes it easier for you to compare different combination of slices from different takes, and hence arrive at the best outcome. There is no limit to the number of comp sets that you can save and use.

Saved comp sets can be applied by selecting the media items (all takes) of the relevant tracks in arrange view, then right clicking over the selection and choosing **Comps** then the comp name from the context menu.

Up and Running: A REAPER User Guide v 5.24

Here is a summary of the commands on the **Comps** sub-menu.

Command	Explanation
Save as new comp	Saves your current selection of takes on all currently selected tracks as a new comp set. You will be prompted for a name.
Rename active comp	Lets you change the name of current active comp set.
Remove active comp	Deletes the currently selected comp set and removes it from the Comps menu. This does not remove any takes or media items from the project itself.
Crop list to active comp	Removes other comp sets from comps menu list.
Move active comp to top lane	Moves all items in take selection to the top lane of its track.
Comp names	Your comps will be listed at the end of the Comps menu (see example right). Choosing any of these will cause that set of takes to be selected.

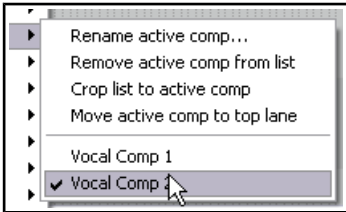

In this example, we have created a second comp set and colored it green. We can now switch between comp sets at will.

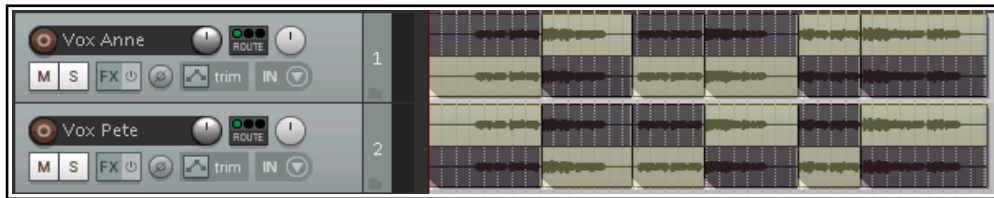

In this example, with our preferred comp set selected we have used the command **Move active comp to top lane**.

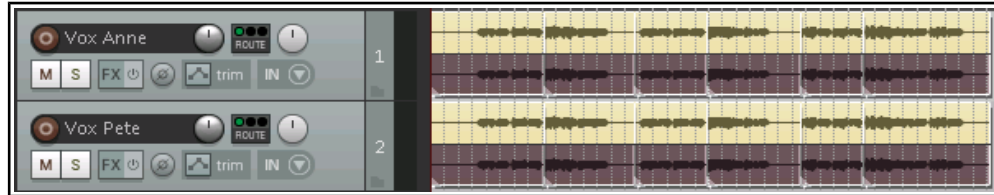

Don't forget also that by pressing **Ctrl L** you can toggle lane display on and off, as shown below.

Tip: When you use lanes and slice and dice in this way, you can use the **Num Pad** keys 1 and 3 to slide items left or

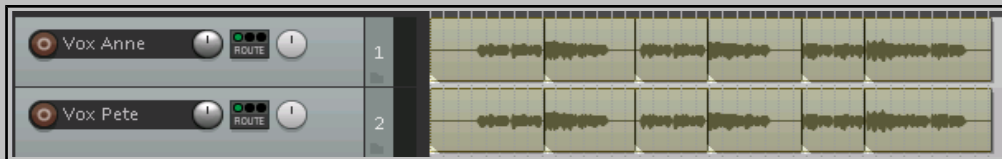



right if their timing is slightly out of sync with other takes. The exact amount by which these keys will slide your selected media item(s) will depend on how closely you are zoomed in or out.

As a rule, you are likely to find that in the earlier stages of post production, you are more likely to want to create and save comp sets for individual tracks, rather than for groups of tracks. This will offer you a great deal of flexibility in how you "mix and match" your various tracks together. However, as your mix progresses towards its completion, you may find that it can be more advantageous to save comped sets for whole selections of tracks, so that they can be recalled and used together.

8 - Arranging, Comping and Editing Takes

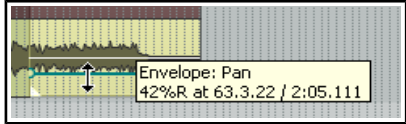
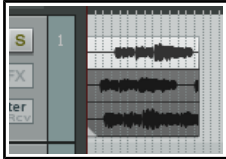
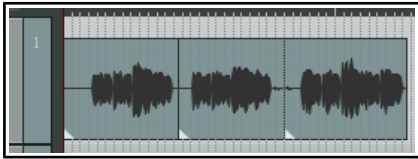
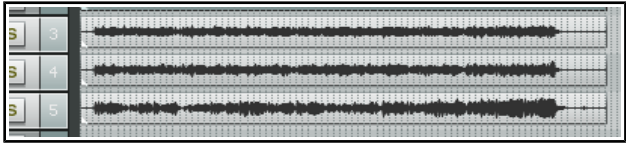
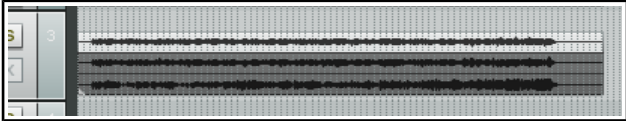
The table below summarizes other **Take** menu management commands that are available to you:

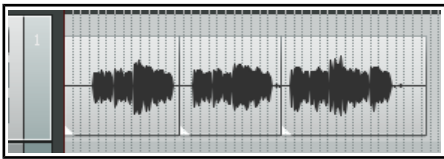
Command (Shortcut)	Explanation
Next take (T)	Makes next take the active take for all selected media items.
Previous take (Shift T)	Makes previous take the active take for all selected media items.
Delete active take (X)	Deletes currently selected take on all currently selected media items.
Crop to active take (Alt Shift T)	Removes all non-active takes from currently selected media items.
Duplicate active take	Adds a copy of the active take to the item as a new take.
Lock to active take	This is a toggle command. It locks the current active take selection. When take locking is applied to a media item, its active take cannot be changed unless this toggle is unlocked.
Show FX chain for active take	Opens the FX browser to allow you to add FX to the active take for the selected media item.
Remove FX for active take	Removes FX previously added to a take's FC chain.
Take envelopes...	<p>Opens a window from which you can choose to add a volume, pan, mute and/or pitch, and/or any take FX parameter automation envelope.</p> <p style="text-align: right;">  </p> <p>Automation envelopes are explained in Chapter 18.</p>
Explode all takes to new tracks	Copies each take to a new track.
Explode all takes in place	Places selected takes on the same track on top of each other, so that all will play at once.
Explode all takes (in order)	<p>Places selected takes on the same track in sequence, one after the other.</p> <p>This command turns this ... into this:</p> <div style="display: flex; justify-content: space-around; align-items: center;">   </div>
Implode items across tracks into takes:	<p>Copies all selected items to a single track as a series of takes.</p> <p>This command turns this ...</p> <div style="text-align: center;">  </div> <p>... into this:</p> <div style="text-align: center;">  </div>

Command (Shortcut)	Explanation
Implode items on same track into takes:	<p>Moves all selected items to the same start time as a series of takes on the same track.</p> <p>This command turns this</p>  <p>into this:</p> 
Paste to takes in items	Pastes previously selected and cut or copied takes into selected tracks as a new item.

8.7 More Take Commands and Actions

The third section of the Items context menu contains a series of commands that involve creating a new take from an existing item. These commands open up for you a number of interesting and creative options.

The first four of these involve applying track effects to an existing media item and are in principle quite similar – the first three create a new audio take and the fourth of these creates a new MIDI take. The table below summarizes these commands.

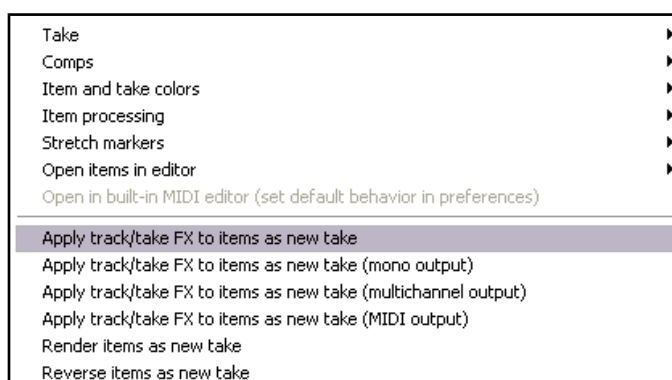

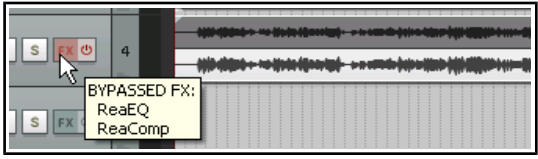
Command	Explanation
<p>Apply track/take FX to items as new take - creates a new stereo take for the selected item.</p> <p>Apply track/take FX to items as new take (mono output) – creates a new mono take for the selected item.</p> <p>Apply track/take FX to items as new take (multichannel output) – creates a new take for the selected item, with the same number of channels as are defined in the track's routing window.</p> <p>Apply track/take FX to items as new take (MIDI output) – creates a new MIDI take on selected MIDI item.</p>	<p>One use for these commands is to free up CPU if your system is becoming stressed. Consider an example of a track with some FX in its FX chain, say EQ and a compressor:</p>  <p>After applying track FX (mono output), we have a new take with the FX applied to it. The original FX chain can now be set to bypass:</p>  <p>This reduces CPU overload, and opens up creative options- e.g. you can select Play all takes then use pan and volume envelopes to vary their placement and relative volume throughout the song.</p>
Render items as new take	This command is another CPU miser. It will render the existing media item as a new take. Any MIDI items with take FX (such as VSTi) will be rendered as audio.

8 - Arranging, Comping and Editing Takes

Reverse items as new take

You can have some fun with this one. It does what it says – it adds a new take to the media item with the material reversed. Here's an example. Starting with this ...

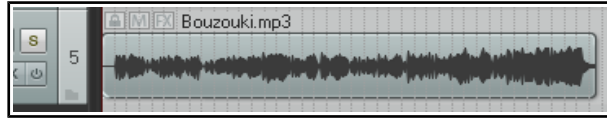

... we end up with this:



As well as these commands, REAPER's Action List (see Chapter 15) includes a number of actions you can use to deal with empty take lanes. These actions (which can be assigned to shortcut keys or toolbars) are:

Item: Remove all empty take lanes

Item: Remove the empty take lane after the active take, and

Item: Remove the empty take lane before the active take

Don't forget how many options you now have ... slice and dice, play all takes, volume, pan and mute envelopes, pitch and/or playback rate shifting, take FX ... and so on!

Footnote: Confused about colors?

REAPER's **Preferences,**

Appearance, Peaks/

Waveforms settings includes

many color options. *These options may be disabled by some color themes, including the default theme.* Where they are enabled, their order of precedence is not obvious.

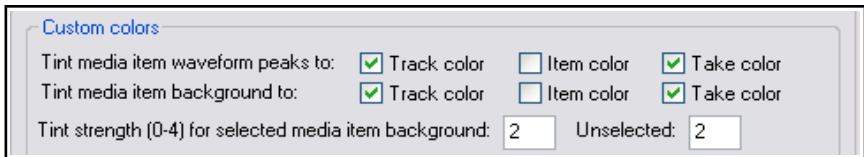

In the example shown here, we have asked for media item peaks and backgrounds to show both track colors and take colors. Clearly to show both of these will not be possible.

In cases like this, the option furthest to the right will take precedence. In other words, for a particular media item, if takes have not been colored then the track colors will be used. If, however, take colors have been specified, then these will take precedence over track colors.

8.8 Managing Comps with the Project Bay

Takes and comps can also be managed from within REAPER's Project Bay.

The Project Bay is a one-stop center which allows for the convenient management of a project's media items, FX, item groups, takes and comps. It is explored and explained in detail in Chapter 12 of this User Guide.

To open and display the Project Bay, use the **View, Project Media/FX Bay** command. Click on the tab labeled **Take Comps** to display the takes and comps management section.

Clicking on the **Options** button (bottom right) displays a menu. This menu is explained in detail in Chapter 12. For now, notice the option to **Mirror selection in bay and project**. When enabled, this allows you to select any media item or segment by clicking on it either in the project itself or in the list shown in the project bay.

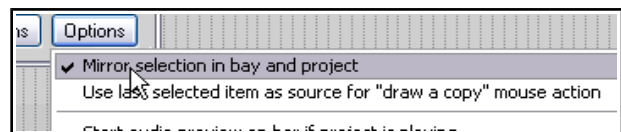

Within the project bay window (see below) you can right click over any listed comp to display its context menu. Choices include commands to **Activate comp**, **Rename comp** and **Delete comp (keep takes)**.

You can also create a new comp from your current take selection by clicking on the **Actions** button (bottom right) and choosing **Create new comp** from the Actions menu.

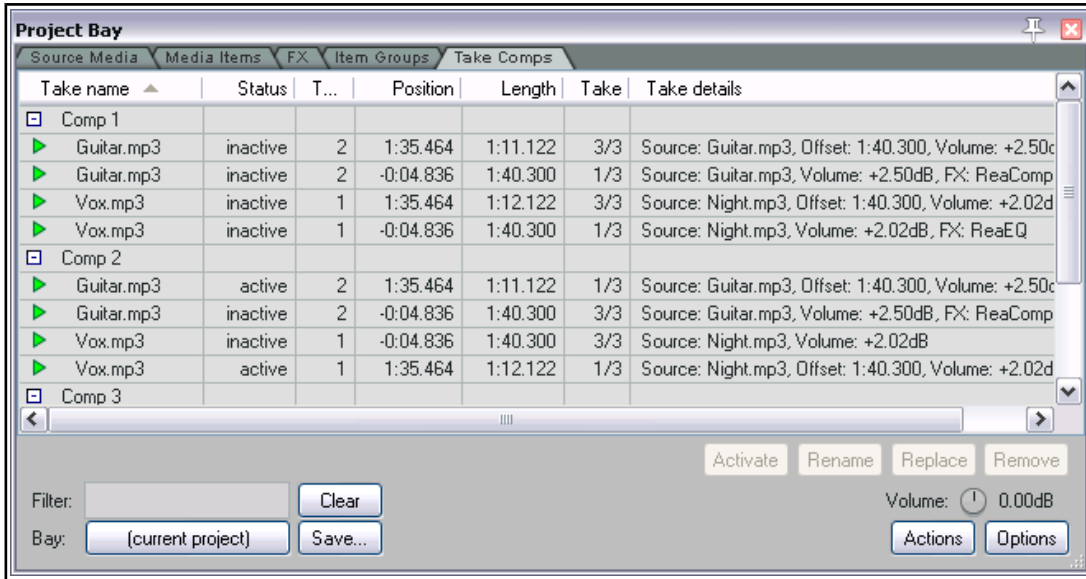

An example of a project with the Project Bay open and the Take Comps window selected is shown above.

The illustration on the right shows how within comp sets you can also select and manage individual takes and items. For example, you can activate or deactivate individual takes, or remove them from the comp altogether.

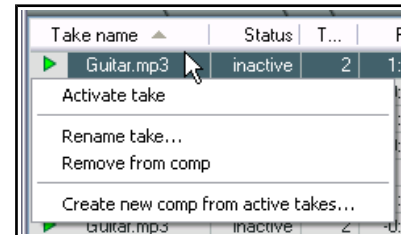

8.9 Propagating Takes

In Chapter 7 you were shown how to copy a media item's properties and characteristics to all similar media items on the same track or on all tracks. The same principle can be applied to takes, using either of the **Item processing** commands **Propagate take to similarly named active takes on track** or **Propagate take to similarly named active takes** (all tracks). Here is an example.

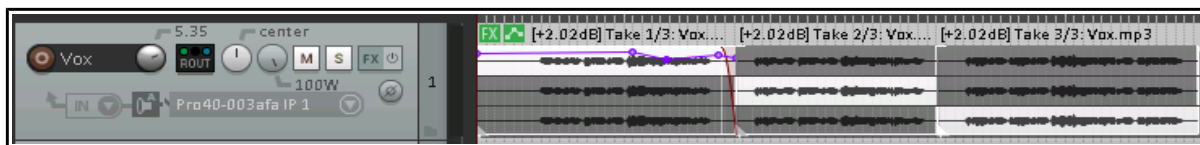

In this example, we have three takes of a media item, which has also been split into three sections. All three takes share the same name (Vox.mp3). Notice that some FX have been added to the active take for the first section, together with an envelope and a fade out.

By choosing **Item processing, Propagate take to similarly named active takes on track** from the context menu, we ensure that these features are copied to the other active takes on this track:

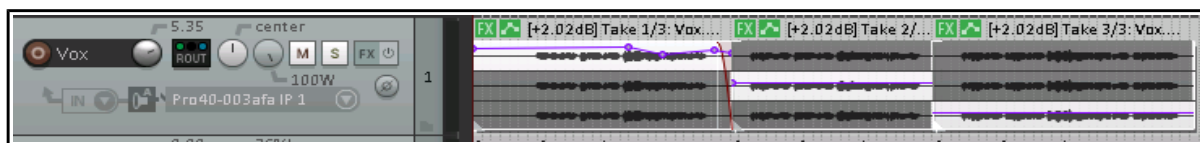

Notice that although the envelope is copied, the envelope points are not.

9 Loops, Markers and Regions

Note: Many of the arrange view illustrations used in this chapter use the REAPER 4 default theme and color scheme. The information and instructions, however, are still accurate and correct for REAPER 5.

9.1 Creating Loops

Any audio, MIDI or click source Item can be looped. Indeed, by default REAPER media items are loop enabled. You can disable this for individual items in the Media Item Properties dialog box, or globally (for MIDI and imported items) on the **Project, Media Item Defaults** page of your Preferences.

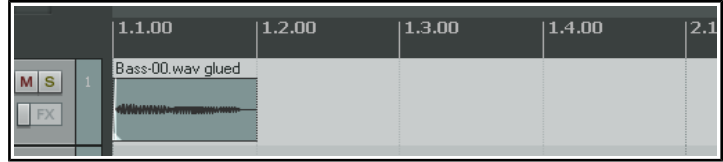

The loop point is defined by the duration of the source media. If you insert an item that is four bars long, it will loop every 4 bars, if it is 8 bars, it will loop every 8 bars, etc. Note that in the following examples, if you are using beats for your timebase, the item must be an exact number of beats in length, or it will not loop in sync. If necessary, adjust the playback rate (Media Properties) while preserving pitch, then glue the item to do this.

To Loop an entire Item:

1. Hover the mouse over the edge of an Item until the Cursor changes to a double-headed arrow (see right).
2. Drag the Cursor to extend the Item. Each loop point will be indicated by a notch in the item edges.
3. The length, start time and end time of the looped item will be displayed as you drag the edge of the loop.



Cropping and Looping:

If you wish to loop only part of an item, then one method is to first crop and glue the item.

1. Make sure snapping is enabled. Hover the mouse over the edge of the Item until the Cursor changes to a double-headed arrow. Click and drag the mouse in on the item to make it shorter, so that you are left with only that part of the item that you want to use as the basis of the loop. Release the mouse button.
2. Right click over the item and choose **Glue items**.
3. Now drag the Cursor to extend the Item. Each loop point will again be indicated by a notch in the edges of the item. Extend the loop as required.

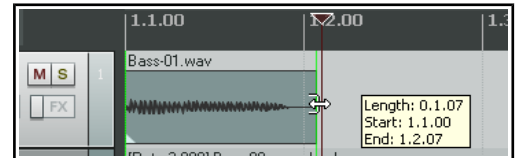

Changing Playback Rate:

There may be times when you will wish to change an item's playback rate, for example to keep it in sync. Taking the same example as above, you would first display the **Item Properties** box, and most probably make sure that **Preserve pitch when changing rate** was selected. You could then change the **Playback rate** (for example, to 2.0). This would have the effect shown here. The original item (looped) as shown above has had its playback rate modified (right).



Creating a Loop from a Time Selection

Another way of creating a loop from only part of an item is to select the required item, highlight the required part of it as a time selection, right click, choose **Copy loop of selected area of items**, remove the original, then paste in the loop in its place. This is shown here:

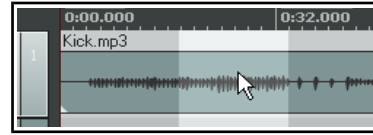

1. Select first the source item, then select the area to be looped (see above). Either press **Ctrl Alt L** or right click and choose **Copy loop of selected area of item**.
2. Select the track and position to which you want the item copied.
3. Press **Ctrl V** to paste in the area to be looped.
4. Drag the cursor from the edge of the item as before to create the loop.

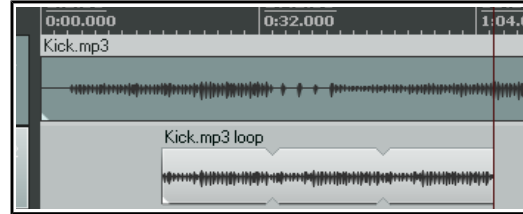

9.2 Creating and Navigating with Markers

Markers are like bookmarks. They can help you when you are navigating, arranging and editing your projects. Markers can be inserted at the current Edit Cursor position, whether or not the project is being played.

Action	Shortcut	Effect
Insert, Marker command	M	Inserts numbered Marker at present position.
Insert, Marker (prompt for name) command	Shift M	Inserts numbered Marker at present position and opens dialog which prompts for a marker name. Other options include Set color... to color the marker.
Right click mouse over marker		Displays menu to Edit Marker or Remove Marker.

Keyboard and Mouse Shortcuts

Default Keyboard and Mouse Shortcuts for creating and navigating with markers are:

To do this ...	Mouse/Keystroke
Go to marker 1 thru 10.	1 thru 0 on main keyboard, not Num Pad.
Move marker 1 thru 10 to cursor position, or create new marker if no marker of that number exists.	Ctrl 1 thru Ctrl 9 and Ctrl 0
Go to next marker/ project end or previous marker/ project start.] or [
To jump to any marker.	Ctrl J opens Jump To dialog. Type m and marker number – e.g. m2 to jump to marker 2.
Jump to marker using the Transport Bar.	Right click on Transport Bar then Jump to marker
Open Edit marker dialog (e.g. to add or change marker name or change marker color).	Shift double-click on marker number. Type a new name, or click on Set color .
Make loop selection in REAPER's main arrange view or in the MIDI Editor piano roll view.	Double-click on ruler between two markers
Select area between the two markers.	Double click on timeline between markers
Move a marker.	Click and drag marker along timeline
Remove a marker.	Alt Click on marker

Example

This example illustrates the use of markers. Before you begin, on the **Options** menu, enable the option **Loop points linked to time selection**.

1. Open the sample file **All Through The Night.RPP** and immediately save it as **All Through The Night MARKERS.RPP**
2. Play the song. Just before the place where the vocal starts. Press **Shift M**. When prompted, type as the name **Verse 1 Start** and press **Enter**
3. At the end of the first verse, press **Shift M** again, name this marker **Verse 1 End** and press **Enter**.
4. Create similar markers for the start and finish of Verse 2 and Verse 3. These will be at or around 1:00, 1:38, 1:46 and 2:35. Save the file.
5. Press **1** on your keyboard (not the numeric keypad). Notice the edit cursor jumps to the start of Verse 1.
6. Press **2**. Notice it jumps to the end of Verse 2.
7. Double click on the timeline ruler (not the markers row) between markers 2 and 3. Notice that this area is now looped and will play repeatedly.
8. Right click over the timeline and choose **Zoom selection**. You could now do any close editing work required for this selection.
9. Press **Esc** to clear the selection, then **Ctrl PgDn** to restore the whole project to view. Save the file.



Note: Do not use the names **=START** or **=END** when naming ordinary markers. These names should be used only when creating special markers which can be used to denote the start and end of a project. This information will be used by REAPER when rendering an entire project to audio media (see also Chapter 21).

9.3 Time Selection Start/End Markers

REAPER treats the start and end of any current time selection as floating markers. The shortcut keys for **Go to next marker** and **Go to previous marker** are **]** and **[**. These will also find the start or end of the current time selection and move the play cursor there.

You can also right-click over the **Go to start** button and enable the option **Use transport home/end for markers**. The Go to start and Go to end buttons will now find the previous/next marker or start/end of a time selection when one is current.

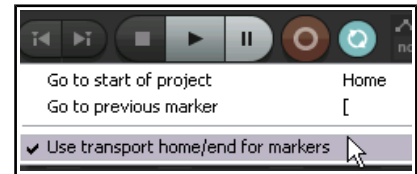

9.4 Snapping to Markers

Optionally, you may wish to ensure that when you are making a time selection, the boundaries of the selection will automatically snap to nearby markers at the start and/or end of the time selection (if any such markers are present).

Consider the portion of the **Snap/Grid Settings** shown on the right. Notice that snapping has been enabled, with a snap distance of 10 pixels defined.

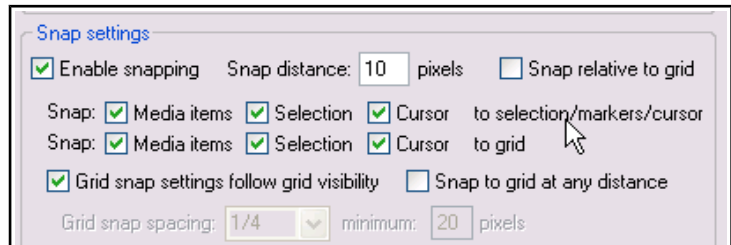

With snapping *disabled*, it can be quite difficult to make a selection which starts or ends exactly at a marker. When you attempt to make such a selection, you might end up with the selection shown in the first of the screen shots below. Notice that the end of the selection doesn't quite match the marker.

However, in the second example shown, with snapping *enabled* and the settings shown

above, if you drag the selection to within 10 pixels of the marker position, the selection will automatically snap to the marker when you release the mouse. Notice the effect of making exactly the same selection with the above snap settings disabled (left) and enabled (right).



Up and Running: A REAPER User Guide v 5.24

Example

In the first screen shot (below), a project contains two markers, one at the start and one at the end of the project.

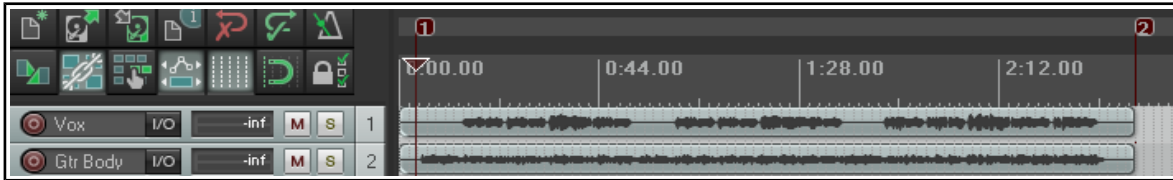

Suppose that you wish to reposition Marker 2 at the start of the second verse. You can simply position the edit cursor there and then press **Ctrl 2**.

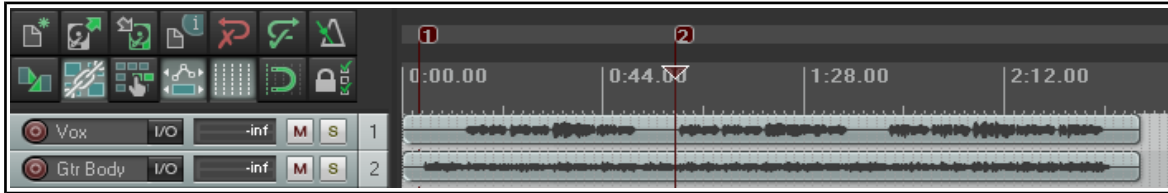

Now let us suppose that you want to create Marker 4 at the end of the song, reserving Marker 3 for a position as yet unspecified. You can position the edit cursor at the end of the song and press **Ctrl 4**.

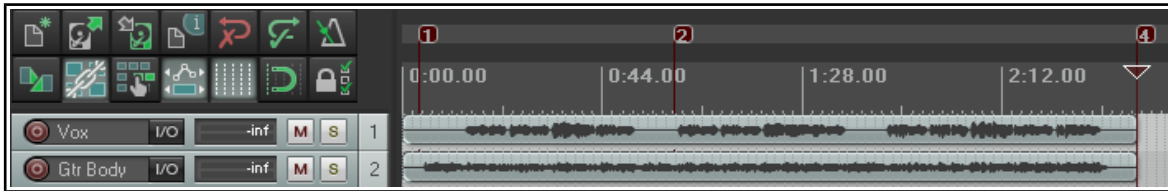

9.5 Removing Markers

There are two main methods of removing unwanted markers.

To remove a single marker

Position the mouse over the marker “flag” and hold down the **Alt** key while you click the left mouse button. Alternatively, you can right-click over the marker flag and choose **Remove Marker** from the context menu.



To remove a series of markers

Define a time selection that includes all of the markers that you wish to remove.

Right click over the space just above the marker “flags” within the time selection, and choose **Remove all markers from time selection** from the context menu.

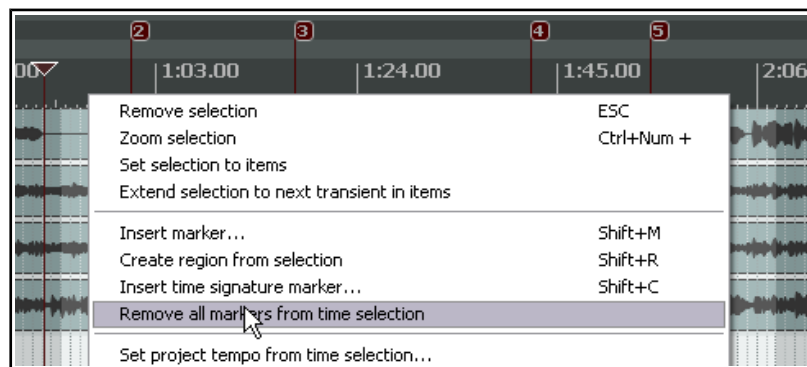

9.6 Marker Actions

Many actions are available (in the Actions List Editor) to help you manage markers. These include **Markers: Delete marker near cursor** and **Markers: Renumber all markers in timeline order**.

Chapter 15 explains in detail more about actions and about how you can assign them to toolbars or to your own shortcut keys.

9.7 Creating and Using Regions

Regions essentially take the idea of markers one step further. You can create regions for your projects, making it easy to identify, select and work with different passages of a song.

To do this ...	Mouse/Keystrokes/Command
Create a new region from the current selection.	Shift R or right click, Create Region from Selection
To change name or other properties of the region.	Shift Double click on region icon.
To specify a color for a region.	Shift Double click on region icon then Set color .
Make the area of the region the current selection.	Double click on region icon, or right click on region icon, Select Region
Remove a region.	Alt Click on region icon

To create a Region from two existing Markers ...

1. Make sure the **Option** for **Loop points linked to time selection** is enabled.
2. Double click on the timeline (not the markers row) between the markers to make the selection.
3. Right click and choose **Create region from selection**.

To create a Region from scratch ...

1. Click and drag across the background area of the Track View to make the selection.
2. Right click and choose **Create region from selection**.

Example of working with Regions

1. Make sure that the **Option** for **Loop points linked to time selection** is enabled.
2. In the file **All Through The Night MARKERS.RPP**, double click on the timeline between the first two markers. This causes this area to be selected.
3. Right click over the timeline, between the markers, and choose **Create Region from Selection**.
4. Hold **Shift** while you double-click on the new region's icon to display the **Edit Region** dialog. Type **Verse 1** and press **Enter**.
5. Double click on the timeline between markers three and four to select this area. Press **Shift R** to define a region. Right click over the icon for this region, choose **Edit Region**, type **Verse 2** and press **Enter**.
6. Repeat this process using the area between markers five and six to create a Verse 3 region. Keep this region selected.
7. Press **Ctrl** with the **+** on the Numeric Pad to zoom in on that region.
8. Press **Ctrl PgDn** to restore the whole project to the screen.
9. Press **Esc** to remove the current selection.
10. Save this file.

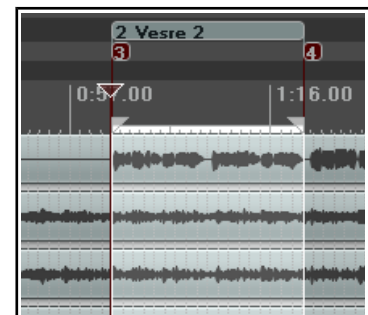
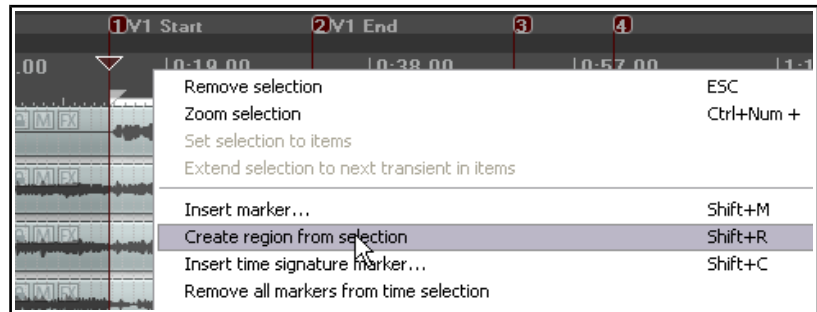

A number of handy actions are available (in the Actions List editor) to help you create and manage regions. These include **Markers: Insert region from time selection** and **Markers: Insert region from selected items** as well as **Regions: Go to next region after next region finishes playing**.

Chapter 15 explains in detail more about actions and about how you can assign them to toolbars or to your own shortcut keys.

9.8 The Region/Marker Manager

The **View, Region/Marker Manager** command toggles this display, used to manage regions and markers.

This table shows how the region manager manipulates markers and regions using its buttons, its controls, and its context menu (displayed by right-clicking on its title bar or in its background area.)

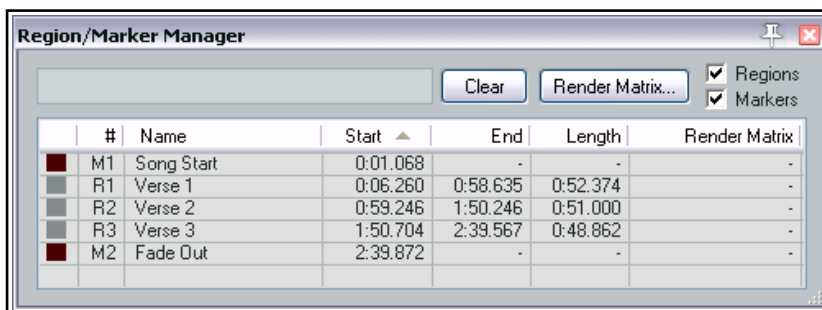

To do this you do this
Renumber markers and regions in timeline order	Choose Renumber in timeline order from context menu.
Go to marker or region and scroll into view.	Enable Seek playback when selecting a marker or region on context menu.
Auto play any region on selection in region manager.	Enable Play region thru then repeat or stop when selecting a region from context menu.
Edit marker/region name	Double-click on marker/region name in table then edit.
Change marker/region color	Click on current color to open color palette.
Edit other marker/region data	Double-click on number, start time, end time or length to edit.
Sort rows in any order	Click on column header, e.g. Color, Name or Start time. In the above example, Start has been chosen as the sort column.
Delete a marker or region	Select the marker or region in table and press Delete . Removes the region definition but not media content.
Show/not show regions or markers in Region Manager	Tick/untick Regions and Markers options (top right).
Change column order	Click and drag column header left or right.
Hide/Show columns	Right click on any header, deselect/select from list.
Open Edit region/marker dialog box	Double-click on region or marker name.
Change region or marker color	Click on small color icon to left of marker/region number.
Zoom to region or marker	Double-click on region or marker number.
Render regions as a separate file each (all tracks)	From context menu choose Mark all regions to be rendered or click in Render column to select required regions and choose Mark selected regions to be rendered from the context menu, then use the Render Matrix... button to open the Render Matrix window. See Chapter 21.
Render only selected tracks within regions, as separate files	After selecting region to be rendered, left click in Render Matrix column to select tracks. For details see Chapter 21.
Export marker/region list as .txt or .csv file	Tick Regions and/or Markers option box(es), choose Export regions/markers... from context menu, then type a file name, choose file type and click on Save .
Import regions/markers from .csv file (replace existing)	Use Import regions/markers (replace existing) command from context menu, select file then click on Open .
Import regions/markers from .csv file (merge with existing)	Use Import regions/markers (merge with existing) command from context menu, select file then click on Open .

9.9 Project Building with Regions

Regions can be used as a very powerful project building tool, especially when you are constructing a project from samples and/or loops. Two especially powerful features of regions are:

- ◆ Drag and drop a region along the timeline to move a region's entire contents.
- ◆ Hold **Ctrl** while dragging and dropping to copy the entire contents of a region.



To illustrate this, take a look at the image above. We have started building a project, with an introduction, then a verse (which has been made into a region), a chorus (also a region) and a second verse.

By holding the **Ctrl** key while clicking and dragging the icon for the Chorus region to the right, to the end of verse 2, we are able to copy the entire chorus to that point (see below).



Notice that any markers and time signature markers that are inside the region will also be copied or moved when the region is copied or moved.

Note: You can also select a series of media items and create separate regions for each item in the selection. To do this, make your selection, then run the action **Markers: Insert separate regions for each selected item**. This action can be run from inside the Actions window, and/or be assigned to a keyboard shortcut, and/or added to a toolbar, and/or added to one of REAPER's menu – see Chapter 15 for more information.

9.10 Changing the Project Timebase

You can select Time, Beats (position, length, rate) or Beats (position only) as the timebase for your envelopes, events and markers. To do this:

1. Press **Alt Enter** to display the **Project Settings** window. Click on the **Project Settings** tab.
2. Make a choice from the **Timebase for items/envelopes/markers** drop down list, then click on **OK**.

You can also change the beat by clicking in the **BPM** box (on the Transport Bar) and entering a number.

9.11 Markers and Media Cues

If you need to share your media files with other applications that use media cues (for example, Sound Forge) you can convert your markers to media cues when rendering. File rendering is covered in detail in Chapter 21. REAPER also has an option on the View menu (enabled by default) to show media cues where they exist on imported media items. Moreover, you can use the **Item Processing** command to create markers within REAPER for these media cues.

Example

1. In the screen shot shown below, our project includes a number of markers:



2. We can now select the appropriate tracks and render the file (using the **File, Render**) command, selecting the option **Stems (selected tracks)** from the Render drop down list, **Mono** channels, and specifying which combination (if any) of markers and regions we want written into the output files as cues. In this example, **Markers only** has been selected.
3. If these rendered files were later imported back into REAPER, we can see that the media items contains cues which correspond exactly with the original markers. This is illustrated below. Notice the series of vertical broken lines which indicate the positions of the media cues.

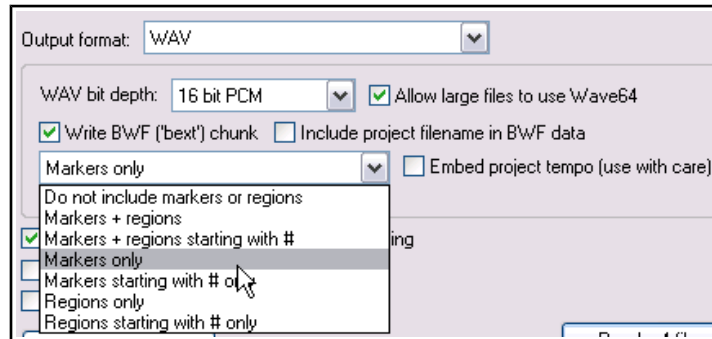

4. If we now select any of these media items then right click and choose **Item processing** then **Import media cues from items as project markers** then a set of REAPER markers and regions is automatically created for the project.

9.12 Tempo Based Music Production

9.12.1 Time Based Music Basics

REAPER incorporates a number of features which make it a good choice for tempo based music production. Some of these elements (such as creating loops and various item properties) have already been mentioned in the context of other uses. Others have not yet been mentioned. In this section we will draw these elements together to give you a flavour of how REAPER can be used for the production of tempo based music. Creating tempo based music is a process that largely consists of creating and sequencing loops from audio samples. These become the building blocks from which a work is created. Individually they can vary in length from a single note to a complete rhythmical pattern, and anything in between.

One advantage that sampling has always had over MIDI is sound quality. There are any number of human performance techniques and subtle variations that it are very difficult if not impossible to simulate with MIDI. However, until recently MIDI held one big advantage over sampling. A MIDI track can easily be transposed without altering its tempo, and its tempo can be changed without affecting its pitch. This has not always been the case with audio.

Take the example of drum loops. One of the biggest problems with using samplers to trigger drum loops has been that when the tempo changes, so does the pitch. Samplers change pitch by slowing things down or speeding things up. This means that as you play keys up and down your keyboard, you must at the same time handle the issue of beat changes. It becomes almost impossible to get the exact tempo you want without having to open the sampler and make adjustments to the loops.

Today, however, there are available many tools that can do all this for you. The time and pitch altering tools that come with REAPER use high quality algorithms which give you all the options you need to change or maintain such factors as length and intonation. It thus becomes possible to modify samples accurately and without distorting their essential characteristics.

ReCycle is one program that has become popular because its REX grooves automatically arrange themselves to the project tempo on import. Bring in a groove and it always fits the song. Take a set of items representing slices in a rhythmic groove, set their timebase to beats, and change the tempo -- magic! They move all over the place but remain exactly in rhythmic time according to the tempo. Using REX files you are able to play back loops at different tempos without altering the pitch. You're on your way to being able to create drum loops and other sounds exactly the way you want them, and with relatively little effort.

Later in this chapter we'll have more to say about ReCycle, and indeed about REAPER's own dynamic splitting capabilities which puts this magic at your disposal. After dynamic splitting, just double click in the BPM area of the transport bar, enter a number and, hey presto! The whole track plays faster, or slower, in perfect pitch. What's more, the whole track will speed up or slow down naturally, without glitches, pauses or stuttering.

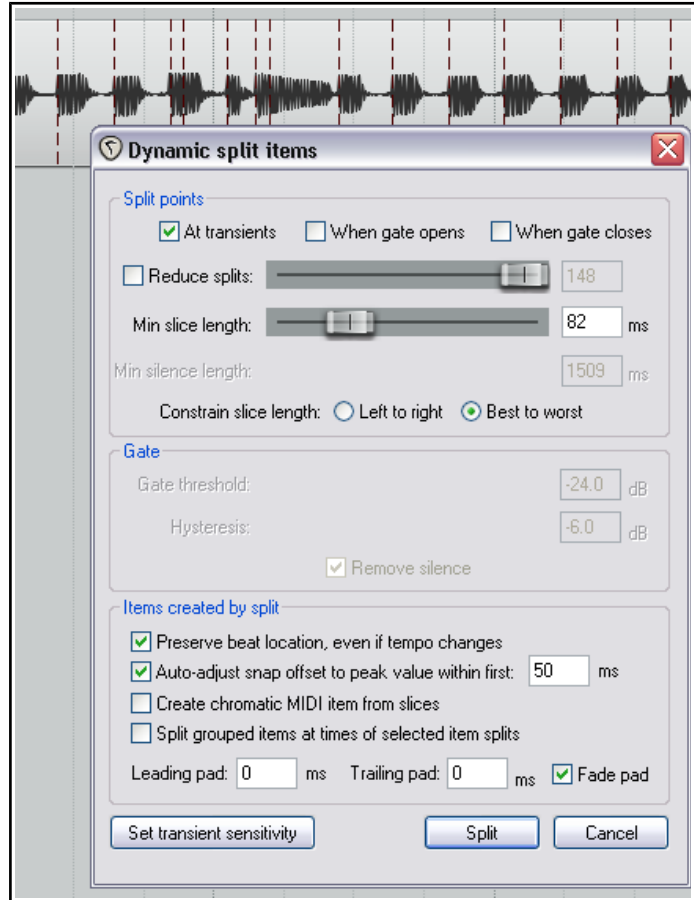

9.13 Project Settings

Before creating any music, you should make sure that your project settings are specified correctly. To display the project settings dialog box, press **Alt Enter** or choose the command **File, Project Settings...** from the main menu. In particular, check the following:

- Under **Project Settings**, Project beats per minute.
- Under **Project Settings**, Time signature.
- Under **Project Settings**, Timebase for events. You can select Time, Beats (position, length, rate) or Beats (position only). The former locks items to the timeline so that changes in tempo will cause items to be resized and their play rate adjusted. With Beats (position only), the start of the item is locked to the beat, but the item contents are not affected or modified by tempo changes.
- Under **Project Settings**, Default pitch shift mode and parameter.

Remember that you can change the timebase for individual tracks (right-click, **Set track timebase**) and for individual media items (**F2**, Item timebase). You can also change properties such as Beats per Minute and Time Signature as often as needed during the song. For example, you can increase the tempo for one passage then restore it to its original setting at the end of that passage. Shortly we will see an example of how this is done.

9.13.1 Audio Media Item Properties

You can record your own media items or import them from existing files. You can also change various properties such as playback rate and pitch for individual media items.

You can specify parameter settings for individual media items and/or for selection of items. For example, if you wish to change the pitch or playback rate for several items you can select those items and press **F2** (or right click anywhere in the selection and choose the **Item properties...** command).

In the example shown, we are increasing the playback rate for the selected items by 5% and preserving the original pitch. Notice that you can override the project default pitch shift mode if you wish. You may find that different algorithms work better with different kinds of audio item (such as vocal, snare, kick or bass guitar). More information about time stretching can be found in the section **Time and Pitch Manipulation**.

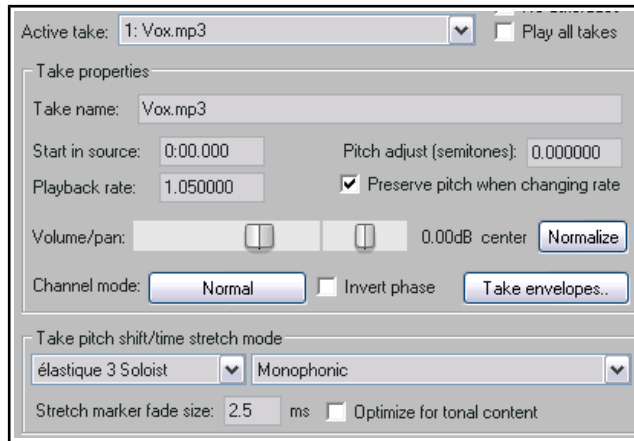

9.13.2 Creating a Loop from a Time Selection

Remember that you are able to select any part of an existing media item and use it to create a loop. This subject is covered earlier in this chapter.

Chapter 15 will introduce you to REAPER's actions and the action list editor. This can be used to assign keyboard shortcuts to many actions that can be useful when you are working with loops and time selections. There are actions, for example, to extend the time selection in either direction, to reduce it from either direction or nudge it in either direction. Browsing and searching the action list will help you to identify those which are most useful to you. Chapter 15 will show you how to bind these actions to your own shortcut keys.

9.13.3 Creating a Loop from Transients

Another method of selecting the area required for your loop is to use the transients in an existing media item. The following actions are just some of the many that can be found within the Action List Editor (Chapter 15). Where no existing keyboard shortcut exists, you can assign your own if you wish.

Item navigation: Move cursor to nearest transient in item	Ctrl Tab
Item navigation: Move cursor to next transient in item	Tab
Item navigation: Move cursor to previous transient in item	Shift Tab
Time selection: Extend time selection to next transient in items	

Assuming that you are using the default key bindings shown above, and that **Ctrl Alt Tab** has been assigned to **Extend time selection to next transient in items**, you can select the item, navigate exactly from transient to transient and select the exact area required.

You can select the item, copy and paste it elsewhere, then right click over it, choosing **Copy loop of selected areas of items** from the context menu.

These are just a few of the actions and commands that can be used to suit your own method of working when creating your tempo-based projects. Explore the others and get to know them. They include:

- Copy selected area of items**
- Trim items to selected area**
- Split items at prior zero crossings**

Copy items	Ctrl+C
Copy selected area of items	
Copy loop of selected area of items	Ctrl+Alt+L
Cut items	Ctrl+X
Cut selected area of items	Ctrl+Delete
Paste	Ctrl+V
Remove items	
Trim items to selected area	
<hr/>	
Nudge/set items...	N
Split items at cursor	S
Split items at prior zero crossing	Alt+Z
Split items at time selection	Shift+S
Heal splits in items	

9.13.4 Transient Detection Settings

The command **View, Transient Detection Settings** causes the window shown here to be displayed.

This can be used to make your transient detection sound more natural and human, by introducing subtle variations in sensitivity and/or volume threshold. Enabling the zero crossings option will help to prevent unwanted clicks.

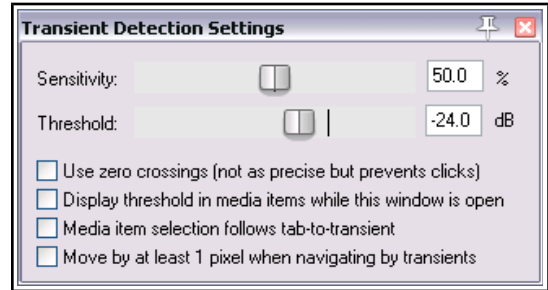

9.13.5 Beat Correction

REAPER includes many actions to assist you with beat detection and beat correction. There are actions to detect tempo, create measures from time selections, extend or swap time selections to the next transient, and more. Some of them are on the context menus and all of them are in the Action List. Any action can be assigned shortcut keys, run from the action list window itself, and/or added to REAPER's **Actions** menu. More information about the Action List can be found in Chapter 15.

How you string these actions together is up to you. Here is an example. You might have a live performance that was not done to a click. It is a simple process to go thru the track and manually tempo-map the whole performance. We're going to assume that you are using the following keyboard assignments:

Tab	Item navigation: Move cursor to next transient in items.
Ctrl Alt Tab	Time selection: Swap left edge of time selection to next transient in items
Ctrl Shift Alt Tab	Time selection: Extend time selection to next transient in items.

Example



In the example shown here, we have used our shortcuts to create and extend the selection out, as required.

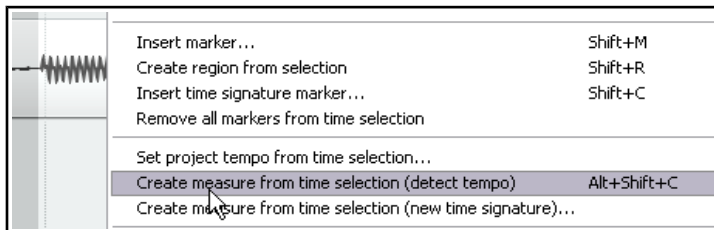

We then instruct REAPER to **Create measure from time selection (detect tempo)**.

We could do this either from the timeline's context menu or using a keyboard shortcut.



We then use our keyboard shortcuts to capture the next time selection required, again using that time selection to create a measure with REAPER auto detecting the tempo.

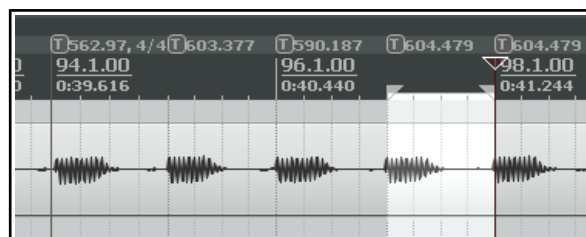

This process is repeated until we come to the first place where a change of time signature is required.

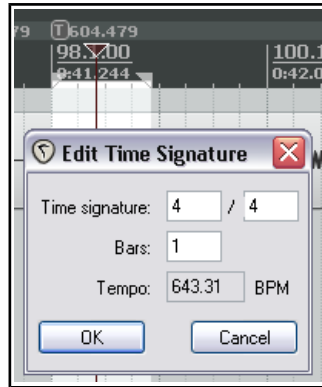

By right clicking over the timeline we display the context menu and select the command **Create measure from time selection (new time signature)**.

This causes the **Edit Time Signature** dialog box to be opened, which you can edit at will then click on **OK**.

This process can then be repeated up to the end of the performance.

9.13.6 Quantizing Items

REAPER allows you to quantize your audio items. This essentially means lining them up according to the project tempo or time signature.

You might have a situation in which you have copied and pasted a sample several times within a track (or across several tracks) and you need to ensure that they are correctly aligned. To ensure that all items are aligned to the beat, you simply do this:

1. Double-click on the track in the Track Control Panel to select all the media items in the track. Alternatively, you could right click drag with your mouse to marquee or "lasso" them.
2. Right click over any of the items, then choose **Item Processing** then **Quantize item positions to grid**. This causes the **Quantize Item Positions** dialog box to be displayed.
3. Specify your required parameters, including the note length setting (1/8, 1/4, 1/2, 1, 2, etc.) and whether you want the items stretched to fit. An example is shown on the right.
4. Click on **Process** for the quantizing to be done.

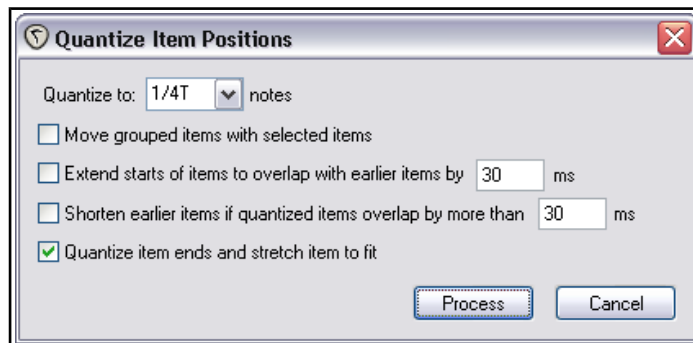

In the example above, the option to also quantize item ends and stretch to fit was enabled.

9.14 Dynamic Splitting

Dynamic splitting is a very powerful feature which has a number of applications. You have already seen (in Chapter 7) how it can be used to remove silence. For example you might have recorded a pretty good bass line that you'd like to use for a song. Maybe it was recorded at 96 beats per minute. The timing might be a bit out at times but on the whole you're pretty pleased with it. The trouble is that you want to use 120 beats per minute for your new song.

Here's another example. Maybe you've recorded a killer slide guitar track. You like it but think it would be pretty clever to give the tune one or two tempo changes. Dynamic splitting is the answer to both these challenges. It works on the principle that you can instruct REAPER to split any media item (or selection of media items) according to criteria that you specify. Basically it works like this:

- You first select the media item (or items) to be split.
- You right click over the item and choose **Item processing, Dynamic split items...** from the menu.
- This causes the **Dynamic split items** dialog box to be opened.
- You give it the information that it needs to work out where to split your items. This will essentially either be to split the track at its transients or to use a noise gate to split whenever the audio volume falls below a specified amount. As you will shortly see, each has its separate uses.

- REAPER then "shadow splits" your selected item(s). That is to say, it indicates with a row of colored bars exactly all of the points at which the item will be split if the parameter settings are left as they are.
- You make such adjustments as you wish to the parameter settings until satisfied that they are right.
- You tell REAPER to split the items.

Once split, each slice of the original item will be set to the current timebase. You can set any of the splits to any other timebase you choose. You can use the items together or individually, according to your needs. Suddenly you've got a whole library of samples!

Dynamic splitting is non-destructive. This means that your original audio files (WAV, MP3, AIF or whatever) remain intact. Nevertheless, if you are going to use this method to build a sample library, it's often a good idea to work on a copy of the original track. This just makes it easier to go back to the original if you wish to use it to make a fresh set of samples. Let's now take a look at an example or two.

9.14.1 Splitting a Media Item into Samples

In the examples below, a recording of a resonator guitar is selected. We have then chosen **Item processing** then **Dynamic split items** from the context menu. Studying these examples will help you to understand how the settings work. In every case, the **At transients** option should be enabled. These examples should be sufficient to get you started. After that, it's up to you to experiment according to your particular needs.

Examples

Only a minimal number of options are used here.

If you specify a very low minimum slice length REAPER will seek out transients with a high degree of sensitivity. This will result in our media item being split into a very large number of items. This might be suitable, for example, if we are intending to introduce tempo changes to the song. The larger the number of samples and the shorter their length, the more sensitive and immediate will be the track's response to any such changes. Consider the two examples shown.

Notice (right) that **Best to worst** has been selected as the method for constraining slice length. This option is likely to be preferred when splitting at transients. Notice also that we have

specified that we want to keep the beat locations unchanged even if the tempo changes. (A further explanation of constrain slice length methods follows immediately after these examples).

Now let's see what happens when we bring some of the other options into play.

In the case shown above right we have set a largish minimum slice length with the result that our media items

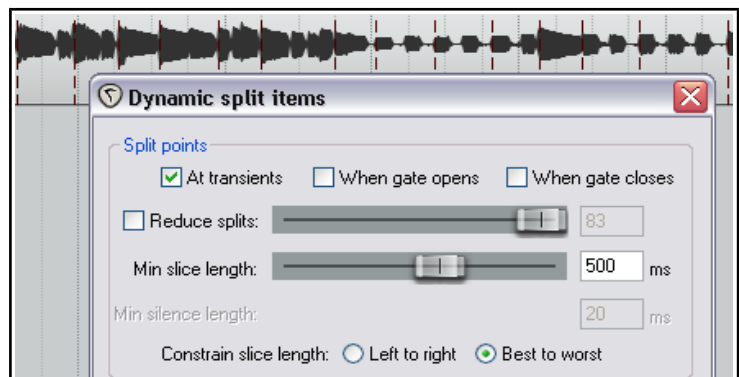
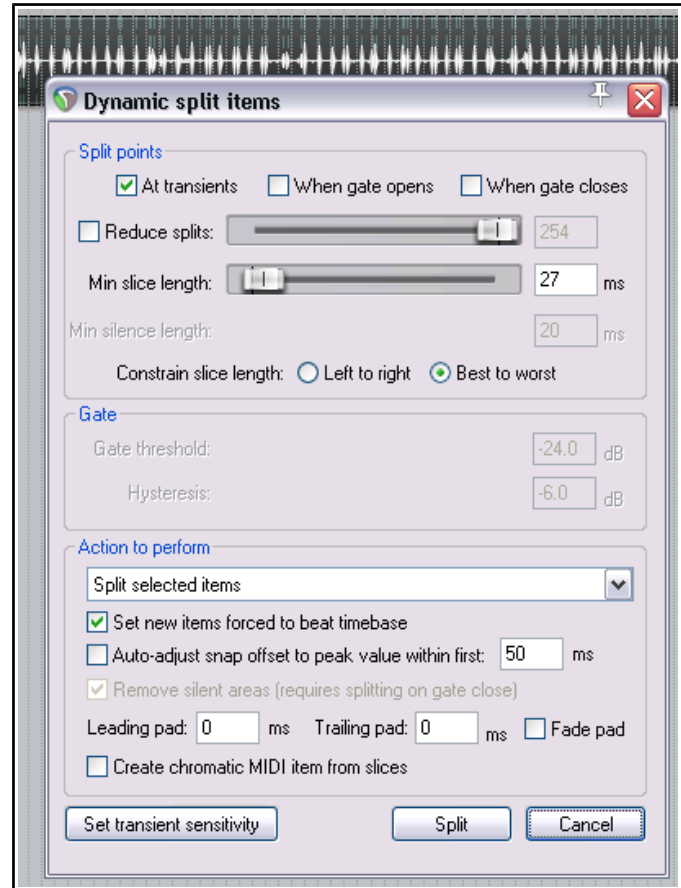

are quite longer. This might be appropriate if we are creating samples to be used with a software synthesizer. However, we might want to do some more fine tuning.

In this next example (lower right), we have increased the minimum slice length and used the **Reduced splits** option to further reduce the number of splits. In this particular case, these settings might be about right for creating our sample library from this bass guitar track.

Before splitting it might in some instances be worth considering whether you wish to enable the noise gate settings to allow you to also remove silence. Whether you would do this would depend largely on the instrument in question and the nature of the tune and arrangement. If the instrument is played continuously and produces an audio signal similar to that shown above, then there may be little point in using the noise gate.

Below we can see how part of our original media item now looks after splitting.

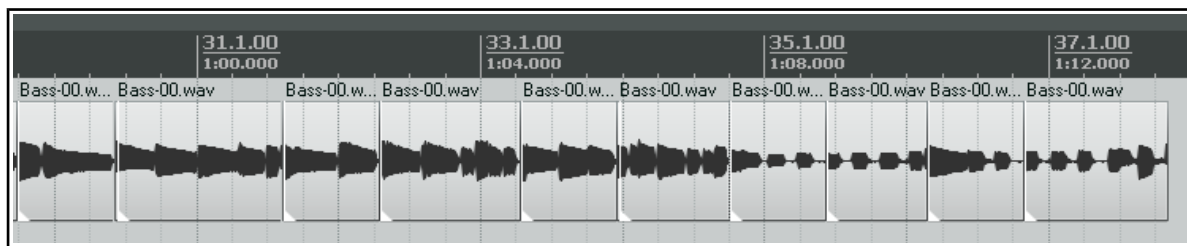
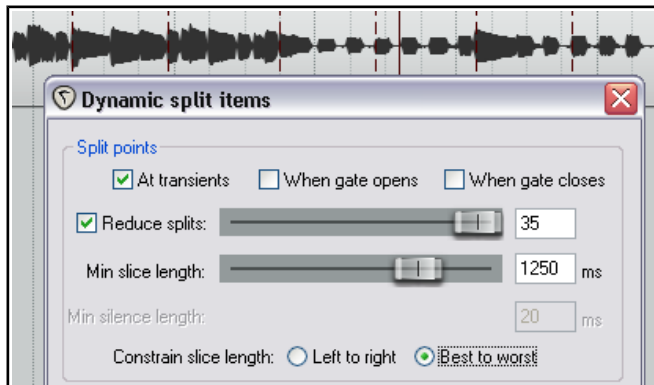

This next example (right) shows splitting at transients with a noise gate employed to remove unwanted background sounds such as drawing breath from a vocal track.

In this example if we were to set the gate threshold too low, too many unwanted sounds would still get thru. If we set it too

high, we risk removing some of the quieter vocal material. You are likely to find that a fair amount of experimenting is needed to get the settings just right.

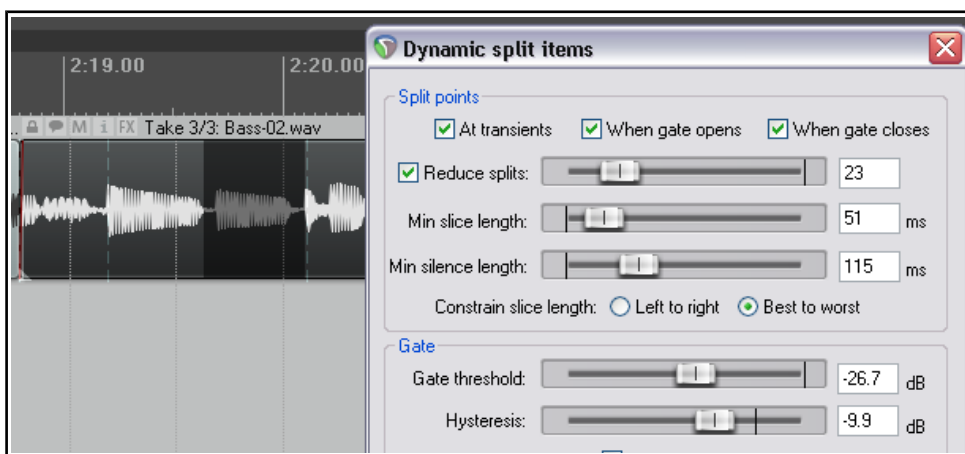

Constrain slice length methods

Left to right means the media is read from left to right, and whenever a transient crosses the threshold, a split point is created. The minimum slice length then determines how close the next split point can be.

Best to worst means the media is read in its entirety, the strongest transient is found, and a split point is created. Then the next strongest transient, and so on.

The difference is that the left-to-right method can end up missing some strong transients if they happen to fall less than the minimum slice length distance to the right of another transient.

9.14.2 Changing the Project Tempo

Once an item has been dynamically split, you can create time signature markers for changes in tempo to which your music will respond when played back. To create these, follow this sequence:

1. Right click over the timeline and choose **Insert tempo/time signature marker...** from the context menu.
2. Specify your required changes in Beats per Minute or time signature. If you wish, you can select the option for a gradual tempo transition between markers.
3. Click on **OK**.

You can double-click on any time signature marker to edit its settings and you can drag it along the timeline to change its position.

These settings, along with more information about time signature markers and their behavior (including editing and moving markers) can be found near the end of Chapter 10.

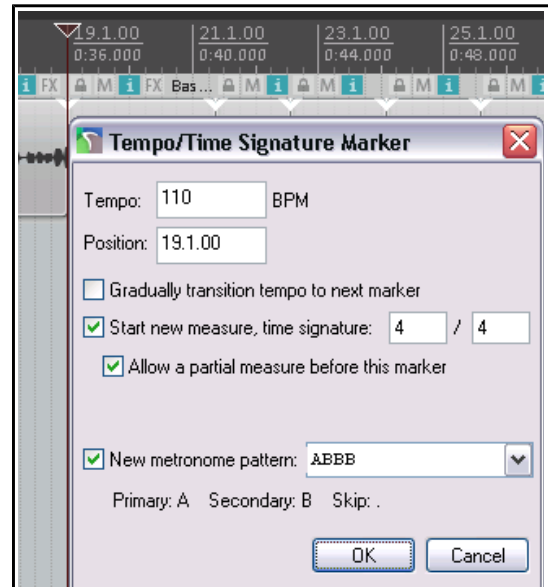

9.14.3 Creating a Chromatic MIDI Item

When dynamic splitting you can select the option to **Create chromatic MIDI item from slices**.

This causes a MIDI item to be created that creates one MIDI event for each slice, moving up the chromatic scale. One common application of this is for sample triggering.

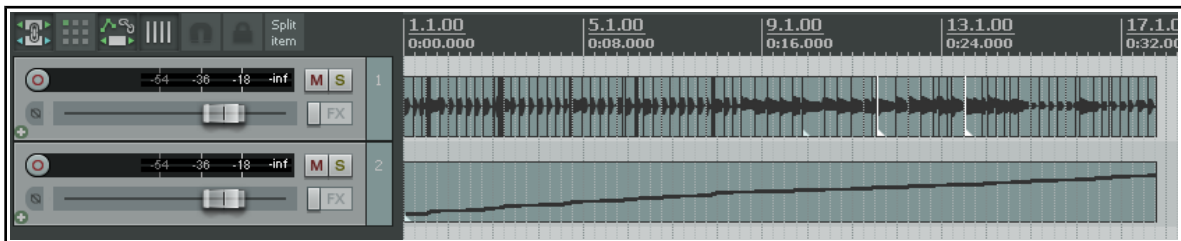

Suppose that you have a groove that you have assembled from various items from different sources. You can now create chromatic midi from the items and then load those items into a sample player, each mapped to the next note in sequence. The midi will then play the groove. Moving the midi notes around changes the groove. It is also quite easy to swap out exactly what it is that is being triggered.

Another example is hit replacement. You can dynamic split a drum part, creating chromatic midi from it. You then have one velocity-sensitive midi note for each hit. It's then a straightforward job to delete a bad hit and use the midi note to trigger a drum sample. Alternately, you can use the whole midi track to trigger a drum sample to double a recorded part (thereby fattening it).

The chromatic MIDI item can, of course, be edited like any other MIDI item with the MIDI Editor, and used to play any synthesizer or sample player. A comprehensive section on using the MIDI Editor can be found later in this User Guide, at Chapter 13.

Leading Pad, Trailing Pad and Fade Pad settings

The examples used in this section have not made use of any of these three settings.

Leading pad is the amount in milliseconds (ms) by which the split point is pushed left of the transient or gate open point when you click on Split. This works both with transient splits and gate open splits. Dynamic split works out where to split and then pads it left by your ms value.

Up and Running: A REAPER User Guide v 5.24

Trailing pad pushes the actual split point to the right by the number of ms specified., and by that same value to the right of the gate close point in gated splits. The actual splits in this case will be to the left and right of the dark area boundaries if you use both When gate opens and When gate closes.

The Fade pad option, if enabled, will fade in and out over the length of those pads.

9.14.4 Saving and Using Samples

After splitting, you can save any of the individual slices as samples. To save an individual sample, simply right click over it and choose **Glue items** from the context menu. The sample wave file can then be imported for use with any VSTi sampling plug-in, such as ReaSamplOmatic5000.

Remember also that if you save the original file with the split items, you can return to it as often as you need to whenever you wish to use it to create more samples.

9.15 REX File Support

REX files consist of sets of groove slices. They are created in and exported from a program called **Recycle** for the purpose of being used in the creation of tempo based music. You can import these files into REAPER either using the **Insert, Media** command or by dragging and dropping from the Media Explorer. When you do this, they will automatically position themselves according to the current tempo.

Once you have imported your REX files into REAPER, you can manipulate and use them in exactly the same ways as you can use other media items that have had dynamic splitting applied within REAPER.

For example, imported REX slices can be made to keep their beat location even if the project tempo is changed.

In your Preferences settings, under **Media, Video/REX/Misc** there are a number of options available for determining how your REX files behave.

You can choose to import REX files as **Beat slices that dynamically adjust to tempo change** or as **A single loopable item at the current project tempo**, or ask REAPER to **Always prompt**.

You can also specify REX tail behavior as any of **Preserve all slice tails**, **Chop all but the final slice tail**, **Chop only the final slice tail**, or **Chop all slice tails**

The Action list also includes a useful action **Item: explode REX item into beat slices**. This can be assigned its own shortcut key if you wish.

10 Pitch and Time Manipulation

10.1 Changing Pitch for Individual Media Items

The pitch of any item can be changed from the **Media Item Properties** dialog box. The pitch is measured in semitones. You can enter a number to raise or lower the pitch of any item by that number of semitones, or you can type in a multiplier, such as **x1.5**.

Notice that there is a drop down list that you can use to select your preferred Pitch shifting / Time stretching algorithm. Choices are:

- Project default (from Project Settings).
- SoundTouch 1.9.0 (allows stretch rates up to 1,000 times and up to 64 channels).
- Dirac LE (better quality, more CPU intensive).
- Simple windowed.
- Élastique 2.28 or 3.1.4 Pro (best).
- Élastique 2.28 or 3.1.4 Efficient (less resource intensive than elastique Pro).
- Élastique 2.28 or 3.1.4 SOLOIST (suitable for monophonic items).

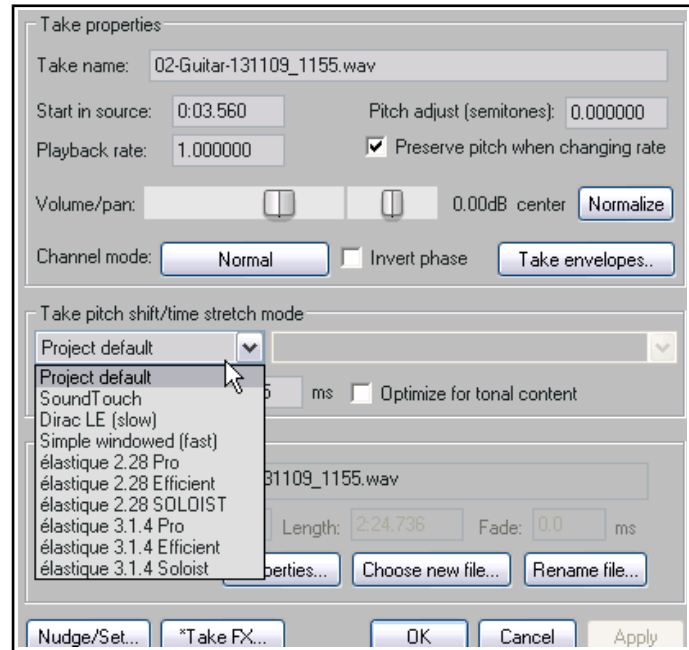

Note: Elastique 3 has now been updated to elastique 3.1.4.

If you choose one of these élastique algorithms, you should also select a Parameter from the different options available for each of the three algorithms. To learn more about these and other features of elastique, go to the zplane web site <http://www.zplane.de/index.php>.

To open the **Media Item Properties** dialog box for any item, first select the item, then press **F2**. The default algorithm is determined by your Project Settings. Keyboard shortcuts allow you to easily and quickly change the pitch of any selected item or group of items without needing to open the Media Item Properties box:

Keyboard Shortcut	Description
Shift 9	Move pitch down one semitone.
Shift 7	Move pitch down one cent.
Shift 0	Move pitch up one semitone.
Shift 8	Move pitch up one cent.

You can also use a take pitch envelope for pitch changes. Right click on the take (or media item if only one take) and choose **Take, Take pitch envelope** from the menu.

For more adventurous pitch shifting escapades you can try using one of the pitch manipulation plug-ins that are supplied with REAPER. Simply open the FX window for a track, click on **Add**, then in the filter list type *pitch* to discover what is available.

Shown here is the **JS Pitch:**

Octavedown plug-in. Other JS pitch shift plug-ins include *fft-ps*, *mdct-shift*, *octaveup*, *pitch2*, *pitchdown* and *superpitch*. These are each suited to particular tasks, but the most powerful of the available pitch shift plug-ins is **ReaPitch**.

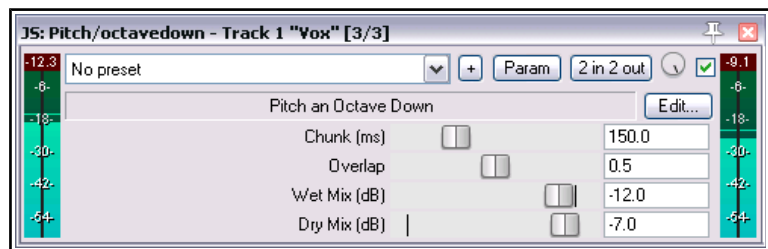

10.2 Using ReaPitch

Simply insert the VST ReaPitch plug-in into a track's FX chain and you have a powerful pitch manipulation tool at your disposal.

For example, you can use ReaPitch to create vocal harmonies.

The first illustration (right) shows ReaPitch inserted into the FX chain for a vocal track. The Elastique Soloist algorithm has been selected, together with the Monophonic parameter. Notice that the pitch has been shifted down by 25 cents and the effect panned 50% right.

In the second illustration, you can see that we have added a second shifter, this time taking the pitch up by 25 cents and panning the effect 50% left, thus creating an extra harmony.

Notice also that in the second illustration we have also adjusted the panning and the mix of the wet and dry signals to produce a more pleasing overall effect.

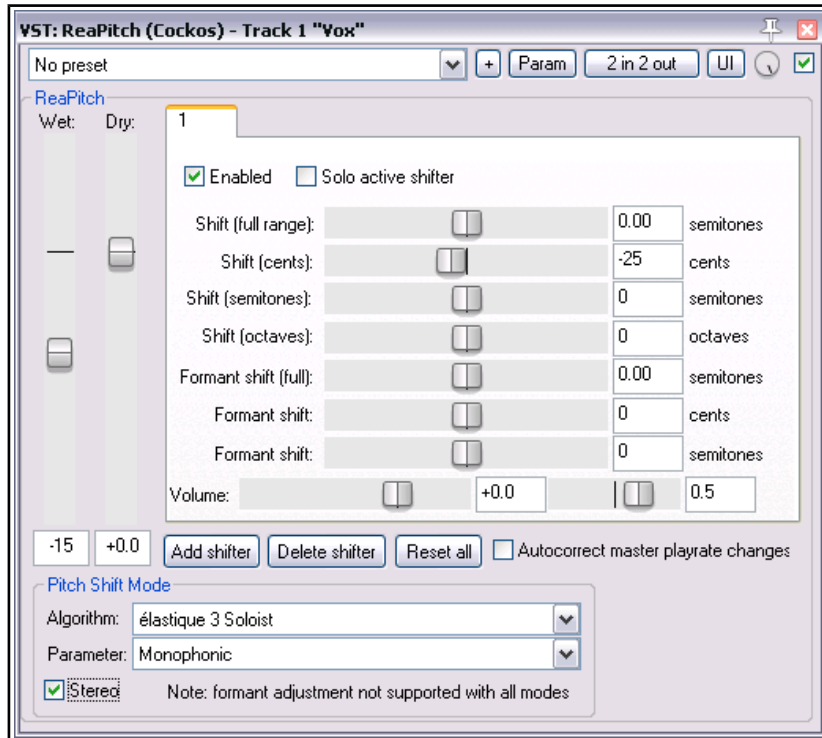

Pitch Shifting and Channel Splitting

If you intend to do a lot of work in this area, you should definitely take the time to get on top of REAPER's channel splitting capabilities. These are explained in some detail in the section **More REAPER Routing Examples** (and elsewhere). Look especially at the example headed **Channel Splitting and Pitch Shifting**.

With channel splitting, you can, for example, not only create several vocal harmonies, but also apply different FX plug-ins or plug-in chains (such as Reverb or Delay) to each of your different harmonies.

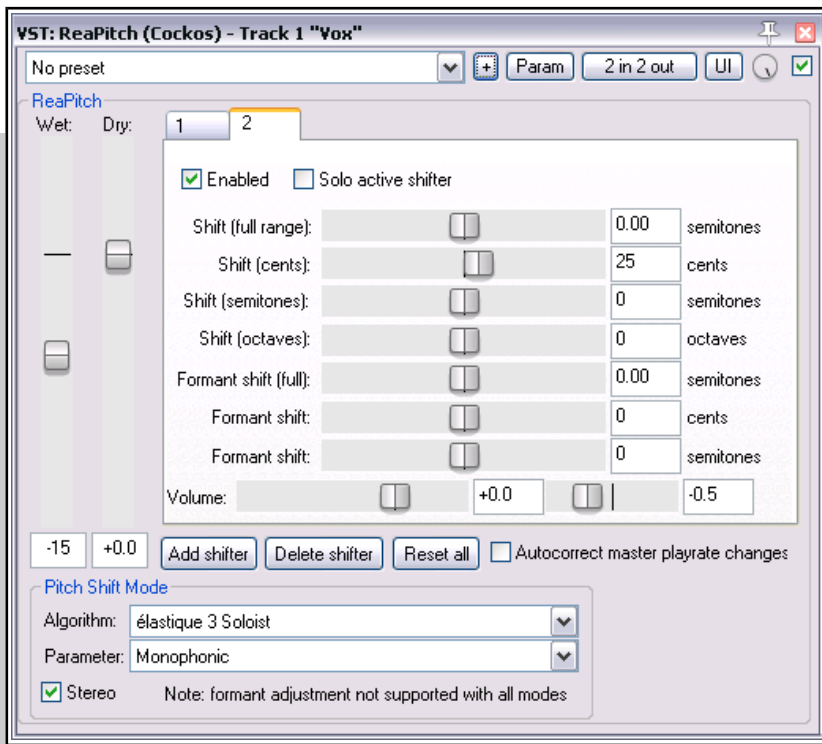

10.3 Using ReaPitch with Multiple Tracks

We've already looked at how REAPER can send audio streams from one track to another. Let's now have a look at how this feature might be used with ReaPitch.

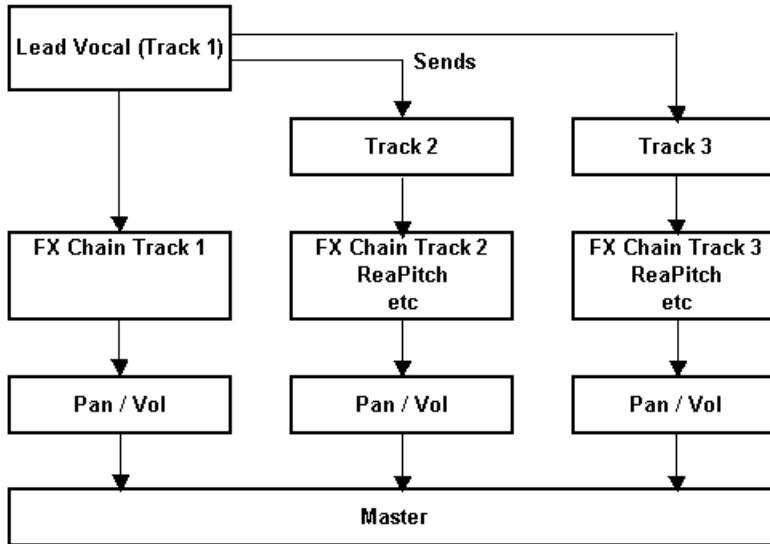

In the example shown on the left, sends are used to send a signal from a Lead Vocal Track to two other tracks.

Each of these other tracks has its own FX chain which includes ReaPitch, and of course the pan and volume faders for these tracks can be controlled independently of each other and of the lead vocal.

Chapter 17 will help you to understand how to go about setting up a signal flow such as this.

10.4 Instrument Tuning with ReaTune

ReaTune is a plug-in that can be used to help you correct the pitch on your recorded media items. This is commonly used with vocal tracks.

However, it can also be used to help you to tune an instrument – see illustration on right.

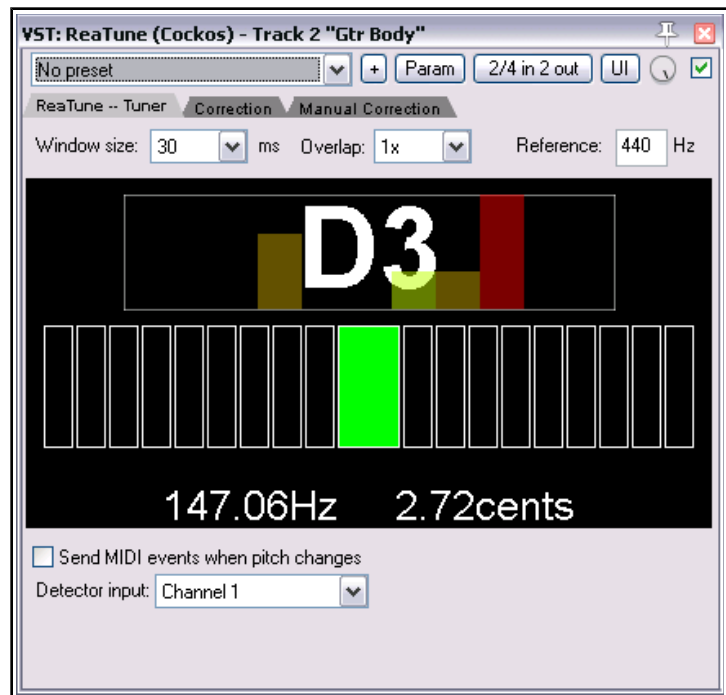

10.5 Pitch Correction with ReaTune

The plug-in **ReaTune** can be used for pitch correction. It can be used in either manual or automatic mode. In either mode, **élastique SOLOIST** is a suitable algorithm.

Automatic mode is illustrated top right. To apply it, first insert the **ReaTune** plug-in into a track's FX window. You should then:

- Select the page headed **Correction**.
- Enable the **Automatic pitch correction** option.
- Select the required algorithm and parameter.
- Specify the correct key and play.



ReaTune will then do the rest for you!

Manual mode is illustrated below right. To use it, first insert the **ReaTune** plug-in into a track's FX window, then:

- Select the page headed **Manual Correction**.
- Enable the **Manual pitch correction** option, and other options as preferred.
- Enable or disable the other options as required. These are **Update**, **Prevent octave shifts**, and **Prevent overlapping segments**.
- Use your mouse (click and drag) to draw your corrections. You can also **Clear** the display at any time.

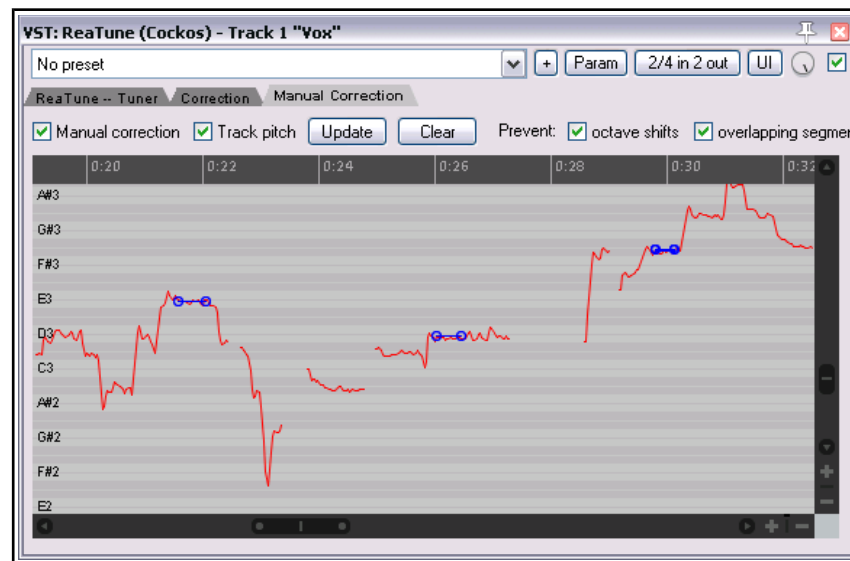

10.6 Changing the Project Play Rate

You can adjust the play rate for the whole project, using the Transport Bar. The project's default pitch shift mode will be applied. You can use any of these methods:

- Click in the **Rate** edit box and type a new value (e.g., to speed up by 10% type 1.1)
- Click the mouse in this edit box and scroll the mousewheel, up to increase or down to decrease play rate.
- Drag the horizontal fader adjacent to the play rate edit box.

In addition to these methods, you can right click over the same edit box or the play rate fader and select one of the options from the menu. From this menu you are able to:

- Reset the playrate to 1.0.
- Increase or decrease the playback rate by any of the values listed.

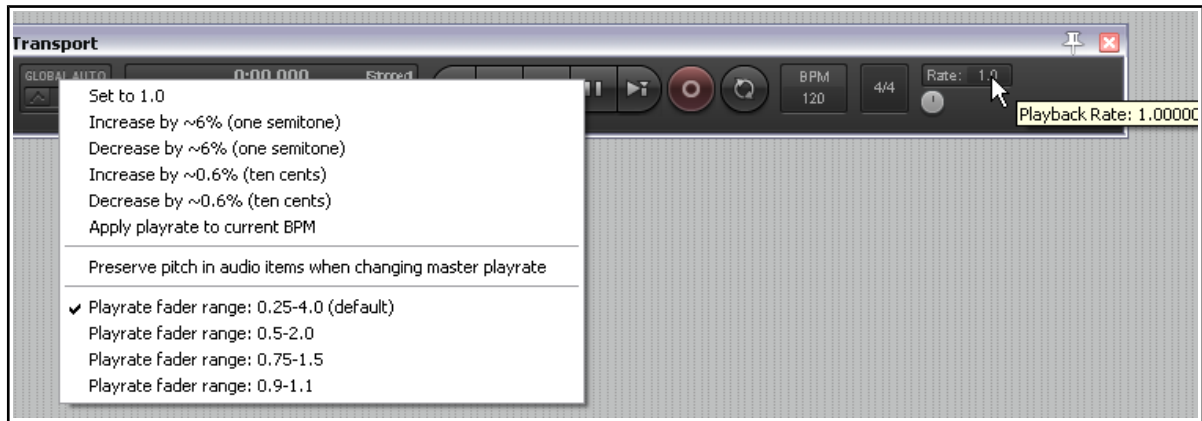

- Enable or disable the option to **Preserve pitch in audio items when changing master playrate**.
- Apply play rate to the current BPM.
- Set the playrate fader range according to any of the available options.

Note: If the playrate fader is not visible in your transport bar, you can display it by right-clicking over any part of the Transport Bar background and selecting the option to **Show play rate control**.

10.7 Time Stretching

The **Take properties** and **Take pitch shift/time stretch mode** sections of the **Media Item Properties** dialog box (**F2**) can be used to stretch or shrink the time for an item.

To do this, adjust the **Playback Rate**. In the example shown (right), playback rate is being increased by 2% and the option to **Preserve Pitch** has been selected. Élastique 3 Pro has been selected for the algorithm to be used.

To open the Item Properties dialog box for any item, select the item, and press **F2**. To do this for a number of items:

1. Select all of the required items.
2. Press **F2**.
3. The **Media Item Properties** dialog will display properties where changes can be made to several items at once. These include pitch adjust and playback rate (see right).
4. Make your changes and click on **OK**.

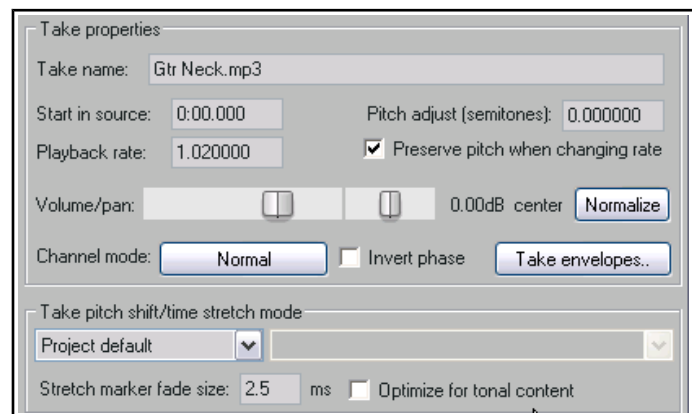

When the Media Item Properties dialog is

opened for more than one item at once, some of the options will be dimmed and are not available when setting properties for multiple items. (such as Take envelopes and Rename file). Most options, however, are available.

Another method of adjusting the playback rate of any media item (or selected group of media items) is this:

1. Select all the required items.
2. Hover mouse over the end of one of the items until it turns to a double-headed arrow, as you would for slip-editing. Hold down **Alt**, click and drag mouse, left to increase playback rate, right to slow it down.
3. Release the mouse when finished.

If you enable the option **Display media item pitch/playrate if set** (Preferences, Appearance, Media) any changes to Pitch or Playback Rate will be displayed on or above the Media Item(s) in Arrange View.



10.8 Stretch Markers

Stretch markers can be used to speed up or slow down part of an item or selection or group of items. They can be inserted at the current play cursor position or at the start and end of a time selection. Unlike standard project markers (which apply to the project as a whole), stretch markers are only applied to the item(s) selected at the time they are inserted. By dragging these markers left or right, the tempo of these items can be changed. To create stretch markers, follow this sequence:

- ◆ Position the play cursor at the point where you want to insert a single marker, or make a time selection starting and ending where you wish to insert two stretch markers.
- ◆ Select the item or items to which you want the marker(s) to be added
- ◆ Choose **Item** from the main menu (or right-click on the item to show the context menu).
- ◆ Choose **Stretch markers** then either **Add stretch marker at cursor** to insert a single marker or **Add stretch markers at time selection** to insert a pair of markers at the start and end of a time selection.

Note that as an alternative to inserting stretch markers, the **Stretch markers** menu has options to calculate transient guides: the same menu also has an option to clear these.

Hover the mouse over the stretch marker to display a horizontal (not vertical) double-headed mouse cursor as shown in the examples below. Stretch markers can then be dragged left or right with the mouse to adjust timing. Holding **Shift Alt** while dragging the first of a pair of stretch markers will move both markers together, preserving the distance and timing between them. Other modifier keys are listed on the table on the next page. Meanwhile, here are some examples showing how stretch markers can be manipulated.



A stretch marker is inserted in this item at the position shown.

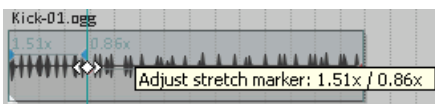

As it is dragged left, timing is made faster before (left of) the marker and slower after (right of) the marker.

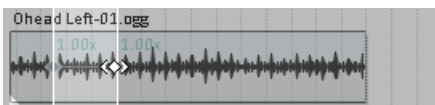

In this second example, stretch markers are added at a time selection.

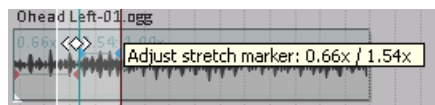

Left marker dragged right to speed up area between markers, slowing down area before. Notice new stretch markers are automatically added to the left and at the start of the item.

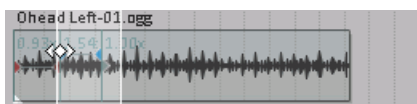

The same marker is dragged back left as Shift Alt are held. Timing before the marker changes but the timing between the original two markers does not change, as both markers and the area between them are dragged together.

Stretch markers can be snapped to grid by choosing **Snap to grid** from the **Stretch markers in selected items** or **Snap stretch markers in selected items within time selection** options on the **Stretch markers** menu.

A stretch marker can be removed by holding **Alt** while clicking on it. Markers can also be removed by choosing **Remove** from the **Stretch markers in selected items** or **Snap stretch markers in selected items within time selection** options on the **Stretch markers** menu. Removing stretch markers will cause an item's timing to revert to its state before the markers were added. To make any changes to the item permanent, instead of removing the stretch markers manually you can **Glue** the item (from the main **Item** menu).

Where a number of items have been selected, markers will be added to the items in that selection. As long as they remain selected, moving one marker in the selection will also move the others. This can be over-ridden by holding **Ctrl** while dragging the marker.

Where items have been grouped, markers added to one item in the group will also be added to other items in that group. By default they will be moved together when one is moved. This can be over-ridden by holding **Ctrl** when dragging the marker. Grouping items is explained in Chapter 7. The following example shows how stretch markers can be used with grouped items.

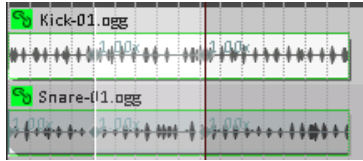

These two items have been grouped. Selecting and adding stretch markers to either item causes the markers to also be added to the other.

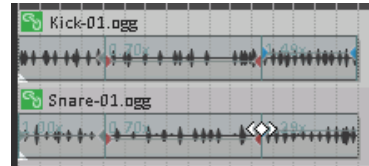

Adjusting the marker position for one item by default makes the same adjustment on other items in the group.

Various modifier keys can be used in conjunction with your mouse (left drag) to modify the behavior when a stretch markers are dragged. These defaults can be changed by selecting Media item stretch markers on the Mouse Modifiers page of REAPER's preferences (see Chapter 15).

Default left drag mouse modifiers for context Media Item Stretch Markers

(none)	Move stretch marker.
Shift	Move stretch marker ignoring snap.
Ctrl	Move stretch marker ignoring selection/grouping.
Shift+Ctrl	Move stretch marker ignoring snap and selection/grouping.
Alt	Move contents under the stretch marker.
Shift+Alt	Move stretch marker pair.
Ctrl+Alt	Move contents under the stretch marker ignoring selection/grouping.
Shift+Ctrl+Alt	Move stretch marker pair ignoring snap.

Other stretch marker mouse modifier choices are available from the Preferences, Editing Behavior, Mouse Modifiers window, including enabling or disabling the option to act on a pair of stretch markers.

You can also use your mouse (left drag) to modify stretch marker **rates**. First, hover your mouse over the stretch markers so as to show a **vertical** double-headed arrow as in the examples below.

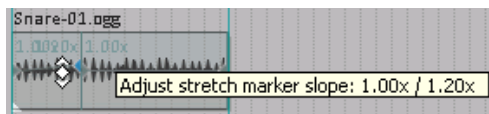

In this example, dragging up causes the playrate to increase up to the stretch marker, thus speeding up playback.

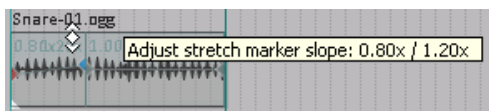

Holding **Shift** while dragging up causes the playrate to slow down at the beginning and speed up progressively thru to the stretch marker.

Default settings are listed below. These defaults can also be changed.

Default left drag mouse modifiers for context Media Item Stretch Marker Rate

(none)	Edit stretch marker rate, ripple markers.
Shift	Edit stretch marker rate.
Ctrl	Edit stretch marker rate, move contents under marker.
Shift+Ctrl	Edit stretch marker rate, move contents under marker, ripple markers.
Alt	Edit stretch marker rates on both sides, ripple markers.
Shift+Alt	Edit stretch marker rates on both sides.
Ctrl+Alt	Edit stretch marker rate on both sides, move contents under marker.
Shift+Ctrl+Alt	Edit stretch marker rate on both sides, move contents under marker, ripple markers.

Other stretch marker rate mouse modifier choices are available from the Preferences, Editing Behavior, Mouse Modifiers window, including the option to ignore selection/grouping.

In addition to the commands and mouse actions explained above, please note that:

- ◆ The Item Properties dialog box includes an option to optimize stretch markers for tonal content.
- ◆ The **Dynamic Split Items** dialog (see Chapter 9) has an option to **Replace stretch markers**. This replaces existing stretch markers in the item(s) and replaced with dynamic splits.
- ◆ Several stretch marker **Actions** are available, for example to go to the nearest, next or previous stretch marker. For more information about REAPER's Actions and Actions Editor, see Chapter 15.

Media Item Stretch Marker double-click modifiers.

Double-click on a stretch marker to reset its value to 1.0.

Ctrl Double-click on a stretch marker to open a dialog (shown here) where you can manually edit start rate, end rate, or both.

These options can also be accessed from the context menu, using the **Stretch marker, Stretch marker at cursor** command.



10.9 Using Time Signature/Tempo Change Markers

The default project Beats per Minute and Time Signature for any project are determined by the values assigned in the **Project Settings** window. You can change this for the entire song by any of these methods:

- Display the Project Settings window (**Alt Enter**) and change it there, or
- Press **W** to return the edit cursor to the start of the song, then either ...
- Type your value in the BPM edit box (shown here) or Time Signature edit box on the transport bar, or ...
- Hover your mouse over the BPM edit box on the transport bar and scroll the mousewheel up or down.

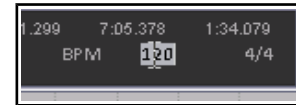

If you wish to make time signature or tempo changes within a song, your Project Settings should use the default setting **Beats (position, length, rate)**.

The project tempo map envelope can be used for changes (see Chapter 18). This works for the most part just like any other automation envelope. Note, however, that editing multiple points at once on this envelope causes each point to be adjusted *pro rata*, not by a constant BPM value.

You can make changes within a song, by inserting a Time Signature/Tempo Change Marker. This changes the beat after the marker position. To change these at any current cursor point, use the BPM or time signature edit box in the transport bar, or:

1. Position the edit cursor at the required place in the song.
2. From the menu, choose the **Insert** command, then **Time signature/tempo change marker** (or press **Shift C**).
3. Specify your requirements in the dialog box (right). Available choices include **BPM**, whether to **Gradually transition tempo to next marker**, **Set new time signature**, **Allow a partial measure before this marker** and (where the metronome is enabled and uses a beat pattern) to define a **New metronome pattern** starting at this point. Click **OK**.

Time Signature markers can later be modified, for example by editing (double-click on marker) or moving them (drag and drop).

Note, however, the following:

- ◆ Tempo/time signature markers are always pinned to beat position rather than time.
- ◆ Manually editing time signature markers requires them to be placed at the start of a measure.
- ◆ With snap enabled (Chapter 7), time signature changes snap to bars, tempo changes snap to beats.
- ◆ With snap disabled (Chapter 7), moving time signature markers will modify the preceding tempo if necessary to ensure that the project contains only complete measures.
- ◆ Time signature changes that truncate the previous measure are marked with a *.
- ◆ Time signature correction may be problematic when a project contains linear tempo transitions.
- ◆ One tempo/time signature marker cannot be moved past another.

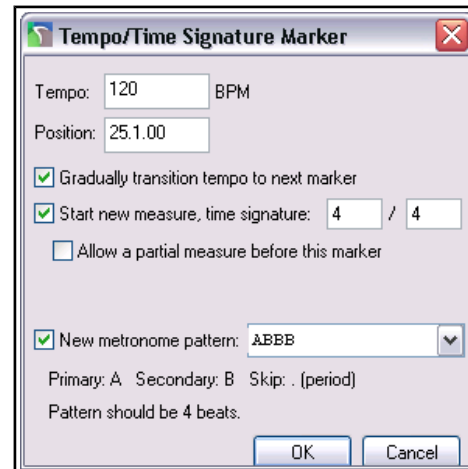

The ruler context menu includes other commands relating to project tempo and measure (shown on the right).

The **Preferences, Audio Seeking** page includes the toggle option **Playback position follows project timebase when changing tempo** – see Chapter 22.

Note also that the right-click menu on the ripple edit toolbar button includes the option **Ripple edit all affects tempo map**.

Set project tempo from time selection (detect tempo)
Set project tempo from time selection (new time signature)...
Set project tempo from time selection (detect tempo, align items)
Create measure from time selection (detect tempo)
Create measure from time selection (new time signature)...

11 The Mixer and Master

11.1 Introduction

Until now, most of the emphasis has been on working in Arrange View. This is hardly surprising, as that is the area where you will find yourself spending most of your time (at least with audio) and doing most of your work. As your mix progresses, however, you will find that the REAPER Mixer becomes more important. The contents of this section should help you to familiarise yourself thoroughly with the REAPER Mixer and its various features and capabilities. You will also learn more about how to get the best out of the REAPER Master.

Mixer display is toggled on and off using the **View, Mixer** command (**Ctrl M**).

Note: Some of the screen shots shown in this chapter use themes other than REAPER 5 default. The commands and actions, however are the same regardless of which theme you are using.

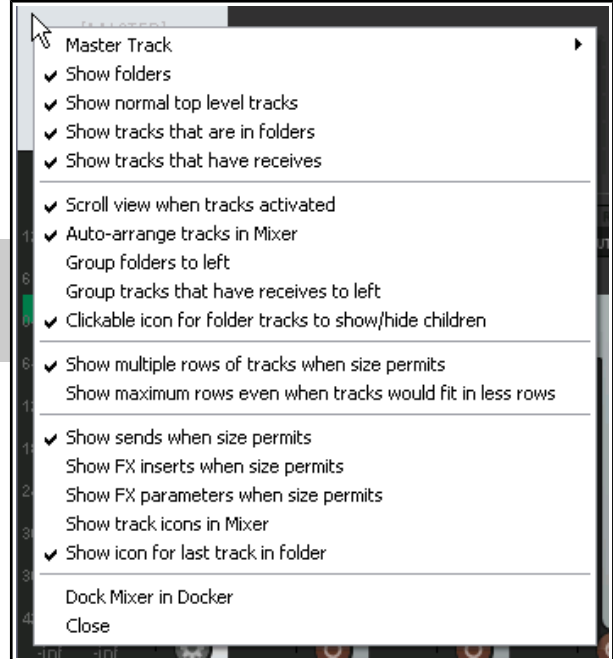

11.2 Mixer Commands

The Mixer menu (above right) is opened by right-clicking over the title bar or any any vacant area of the mixer window, or by clicking over the word "Master" on the Master track, or (when docked) right-clicking on the Mixer tab in the docker.

This menu offers you much flexibility as to how the mixer is displayed. For example, you can choose whether or not you wish to display (and be able to manage) your FX and sends in the mixer. The main mixer menu options are summarized overleaf.

You can also access the TCP context menu in Mixer view by right-clicking over any track name or number.

11.3 Mixer Layouts and Screensets



Commands on the Mixer menu let you select *what* is displayed in the mixer: mixer layouts let you decide *how* it is displayed. Chapter 12 - Project Management Features, covers the topic of layouts (TCP and MCP) in more detail, but for now note the following:

- ◆ Layouts are created and saved with, and attached to, individual color themes, not within REAPER itself. An example of an alternative mixer layout (Session mixer) is shown here (left). The theme that you are using might not include this exact same layout. Themes can be downloaded from stash.reaper.fm. To select an installed theme, use the **Options, Themes** command.
- ◆ Layouts can be accessed by choosing **Set Track Layout** then **Mixer Panel** from the TCP context menu, or **Options, Layouts** from the main menu, or by the **View, Screensets/ Layouts** command, then selecting the **Layouts** tab.
- ◆ Mixer layouts are assigned on a per track basis. If using the context menu, you should first select the tracks for which you want the layout assigned. If using the Screensets/Layouts window you can choose to apply the layouts globally or to selected tracks only.

Before getting too involved with layouts, however, it will pay you to familiarise yourself with the Mixer menu commands and what they do.

11.4 Mixer Menu Commands and Options

Command	Description
Master Track	Leads to a sub-menu of toggle options for Master Track: Show in mixer Show on right side of mixer Show in separate window Show in docker The View, Floating Mixer Master command (from REAPER's main menu) can also be used to toggle the floating of the Mixer Master in its own window.
Show folders	Determines whether track folders are shown.
Show normal top level tracks	Determines whether tracks not in folders are shown.
Show tracks that are in folders	Determines whether tracks in folders are shown.
Show tracks that have receives	Determines whether tracks with receives are shown.
Scroll view when track activated	If there is not sufficient room in Mixer view to display all tracks, the mixer will scroll to follow the TCP track selection.
Auto-arrange tracks in Mixer	Mixer track order will follow any changes to track order made in the TCP. Disable this if you want to arrange tracks in a different order in the MCP and TCP.
Group folders to left	Places track folders to the left. This can be useful at times in bringing all your submix folders, but confusing at other times for separating folders from their child tracks.
Group tracks that have receives to left	Places all tracks with receives to the left. Especially useful if the only tracks with receives are all buses.
Clickable icon for folder tracks to show/hide children	Enables folders to be opened/closed to show/hide child tracks.
Show multiple rows of tracks where size permits	Shows tracks displayed in up to three rows when tracks will not fit in one row and the mixer window has sufficient height.
Show maximum rows even where tracks would fit in less rows	Causes tracks to be displayed in as many rows as will fit in the track height, regardless of how few tracks there are.
Show sends when size permits	Displays a Sends bin above the track controls.
Show FX inserts when size permits	Displays an FX chain area above the track controls.
Show FX parameters when size permits	Shows FX parameter controls: right-click on any of these to assign control to an FX parameter.
Show track icons in Mixer	Track icons (if used) will be shown in tracks in the mixer.
Show icon for last track in folder	Displays the last track in folder icon for last track in folder.
Dock Mixer in Docker	Docks the mixer in the REAPER docker.
Close	Closes the Mixer view.

Tip: Double-click on any track panel in the Mixer to toggle on and off zoom to track in the TCP. This behavior can be changed on the **Mouse Modifiers** page of your preferences (see Chapter 15). You can also use the **Mouse Modifiers** page to add further actions of your own. For example, you could assign **Ctrl Double-click** to the action **Track: Set to custom color ...** How to assign your own actions is also explained in Chapter 15.

11.5 Showing and Hiding Types of Mixer Tracks



Take as an example the above project. It has two folders (or parents) - Vocals and Instruments, containing two and three child tracks respectively - and one top level track, called Reverb. There are sends from the two folders to the Reverb track (which acts as a bus), and the tracks have some FX in them.

The four "Show" commands on the Mixer menu are used to determine which types of track are displayed.

In the example shown here we might have reached a stage in our mixing where we are happy with the balance within our submix folders and want to focus on getting the balance between the submixes and the level of our vocal and instrument folders and our reverb bus just right.



In this case, we could elect to show not the tracks that are in the folders, but only the folders, tracks that have receives and our master track (on the right). This example also uses a sidebar mixer layout.

The example shown here is a simple one: imagine how useful this feature might be if your project contained perhaps 90 individual tracks inside perhaps a dozen submix folders and with maybe another half dozen buses! In that case, you might also find one or more of the Show and Group commands to be very handy.

The Mixer menu does not have the facility to specifically hide or unhide named individual tracks. However, this can be done using the Track Manager. The Track Manager will be explored in Chapter 12.

11.6 Working with FX in the Mixer

If you wish, you can do just about all of your FX management working in Mixer view. You can add FX to tracks, move or copy them from one track to another, open the FX window for any plug-in, or open the track's FX chain for more complete FX control. For this to be possible, though, you need to enable on the Mixer menu the option **Show FX inserts when size** permits. The table below summarizes these and other activities.

In order to do this you do this
Change the order of plug-ins in the FX Chain.	Drag and drop up or down the order.
Copy FX from one track to another (similar to Track View).	Drag and drop FX to FX area on another track.
Display FX context menu	Right click on any displayed plug-in name.
Display the Add FX window.	Click in any vacant area of the FX area.
Display the FX chain and the control window for that plug-in.	Ctrl click on any displayed plug-in name.
Move FX from one track to another.	Alt drag and drop to another track.
Open and float a plug-in's control window.	Click on the plug-in name.
Remove a plug-in from FX Chain.	Alt click on plug-in name.
Remove all plug-ins from a track's FX Chain.	Alt click on track's FX button.
Toggle offline status of a plug-in.	Ctrl shift click on plug-in name.
Toggle bypass state for a plug-in.	Shift click on plug-in name.

In addition, right clicking over the FX area of any track in the Mixer produces a context menu as shown on the right. If you click over an empty part of the FX area then some commands (such as **Float FX configuration**) will not be available. If you right click over an actual plug-in name then you will be presented with the full menu. You can use this for any of the following:

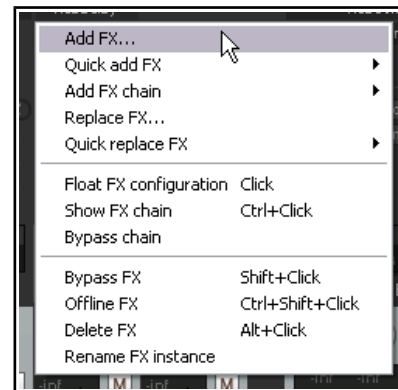

Add FX... Opens FX browser for you to add any installed FX plug-in(s),

Quick Add FX Displays a sub-menu of recently used FX: you can select any item from this menu to add to the track's FX chain.

Add FX Chain Displays a menu of FX chains, any of which you can select and insert in this track.

Replace FX... Opens FX browser for you to replace selected FX with any other: any existing routing configuration will be preserved.

Quick replace FX... Opens sub-menu of recently used FX, from which you can choose any item to replace the selected FX.

Float FX configuration Opens the FX window for the selected plug-in.

Show FX chain Opens FX chain for the track: same as clicking on the track's FX button.

Bypass chain Sets FX chain for this track to bypass. Same as clicking on the track's FX enable/disable button.

Bypass FX Sets the individual plug-in to bypass mode.

Offline FX Sets the individual plug-in offline.

Delete FX Removes this plug-in from this track's FX chain.

Rename FX instance Allows you to give an individual name to this particular FX instance.

Track FX Parameter Controls

You can turn your mixer into your own truly customized mixing console by adding controls directly to the mixer track panels for those FX parameters that you find you are most likely to need to tweak most often.

You'll find more useful information about this in Chapter 12, Project Management Features. Meanwhile, it's easy to get started. Let's see how you would go about creating a console like that shown below.



Notice the rotary faders for Band 2 and Band 4 EQ gain on every track.

Example

You can use one of your existing project files for this example.

1. Open one of your earlier project files, for example, **All Through the Night MARKERS** and save it as **All Through the Night MIXER**.
2. Display the Mixer. Undock it, and adjust the width and height of this window as you prefer.
3. From the Mixer menu enable **Show FX inserts when size permits** and **Show FX parameters when size permits**.
4. Insert into the first track an instance of **ReaEQ**.
5. Select the band 3 settings page.
6. Click once on the **Gain fader** control for this band, then click on the **Param** button to display the Param menu.
7. Click on **Show in track controls**.
8. Select the band 2 settings page and click once on the gain fader for this band.
9. Click on the **Param** button to display the Param menu. Click on **Show in track controls** (see above). Close the EQ window.
10. In the mixer, you should now see these two controls displayed for track 1. 1. Drag and drop the ReaEQ from track 1 in turn to each of the other tracks. Save the file.

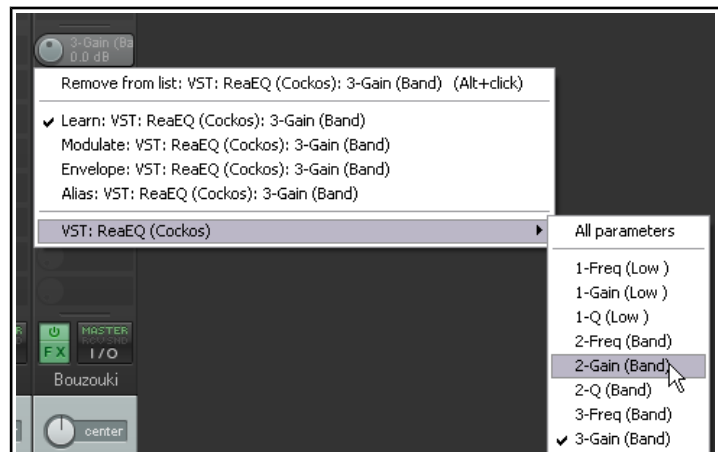
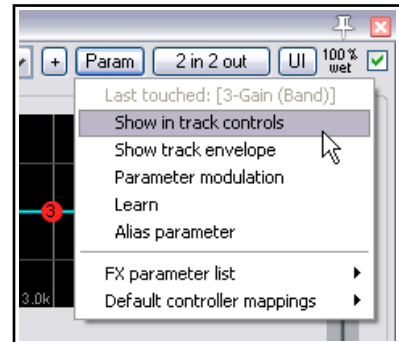

Note 1: These controls can also be assigned within the Mixer. Right-click over the control button, then choose the FX and parameter from the context menu (see above). Choose **All parameters** if you wish to add a control for each of the FX parameters.

Note 2: These controls will be added to the track control panel as well as the mixer panel. You could of course have created as many controls as you like, not just these two. This exercise was just an example.

Note 3: When we revisit this topic in Chapter 12, you will see that we have a couple of options up our sleeves for making it easy to have controls like this automatically added to new tracks as they are created.

11.7 Working with Sends in the Mixer

Enabling the **Show sends when size permits** option from the Mixer menu will cause your existing sends to be displayed, each with a small rotary fader to enable you to adjust the send volume level directly from the mixer panel. Right clicking over an existing send causes a menu to be displayed with the options shown here. Right clicking over an empty part of a track's sends area will produce a menu with only one command – **Show track routing window**. This can also be displayed by left clicking anywhere on the track's empty sends area.

Show send parameters Opens a small window with parameters (volume, pan, etc.) for that send.

Mute send Toggles the send's mute status.

Remove send Deletes the send altogether.

Show track routing window Opens the track's routing window.

Go to send destination track Selects the send's destination track.

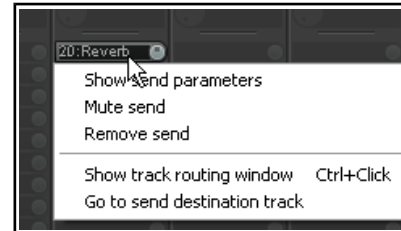

As well as this menu, a number of other techniques are available for creating, editing and managing your sends. You can drag and drop from the ROUTING button of one track to another (as in the TCP) to create sends, but using the sends area of a track's channel strip for this purpose offers you more options. This can be seen in the following table:

In order to do this you do this
Add a send from one track to another.	Drag and drop from one track's send area or ROUTING button to the other. In the latter case, a send control window will be opened.
Add a send from one track to another and open control window for that send.	Ctrl drag and drop from one track's send area or ROUTING button to the other.
Add a send from one track to another and disable send from first track to the master.	Alt drag and drop from one track's send area or ROUTING button to the other. Use this method to create sends from several source tracks to the same destination track to create a traditional submix.
Add several sends to one track in one action	Select all sending tracks. Hold Shift while dragging and dropping from send area or ROUTING button of any selected track to receiving track.
Add several receives to a track in one action	Select all tracks from which you want the sends to come. Hold Shift while dragging and dropping from the ROUTING button of the receiving track (unselected) to any of the selected tracks.
Copy a send from one track to another	Drag and drop the send to another track.
Delete a send.	Alt click on the send.
Display a context menu.	Right click on any send
Open entire routing window for a track.	Ctrl click on a send <i>or</i> Click in empty part of sends area <i>or</i> Click on the ROUTING button.
Open the control window for a send.	Click on the send – allows you to change volume and/or pan, specify send/receive channels, mute etc.
Raise or lower the send volume level.	Click and drag on a send's control knob.
Toggle a send's mute status on or off.	Shift click on the send.

Note that in the above table, those actions which use the routing button can be carried out in both the Track Panel and the Mixer Panel.

11.8 Showing Track Icons in the Mixer

The option to **Show track icons in Mixer** (from the Mixer menu) can be enabled to ensure that any track icons that you have allocated will be displayed at the head of the track's mixer panel.

Track icons are inserted using the **Custom track icons**, then **Set track icon...** commands from the TCP menu. This menu can also be accessed from within the Mixer by right-clicking over a track's name.



11.9 Managing the Mixer

Note: The sample layouts used in the illustrations in this section are illustrative only and have been selected for learning purposes. They will not necessarily look *exactly* the same as the layouts that you are using.

You might find yourself faced with conflicting objectives when you want to display track FX inserts, sends and so on all at once and for all tracks, especially if you have a large number of tracks.

One option for displaying more tracks is to enable **Show multiple rows of tracks where space exists**. Shown here is an example of what might happen when you enable this option.

The problem has arisen that all the tracks have been squeezed into the window – but now there doesn't seem to be enough room to show all the features that we need to see.

In this example, there appears to be not enough room to display all of the track FX and the sends. When this happens you have two main options. These are either to make manual on-screen adjustments to the relative size of the different parts of the track panels, or to use a thinner mixer layout.

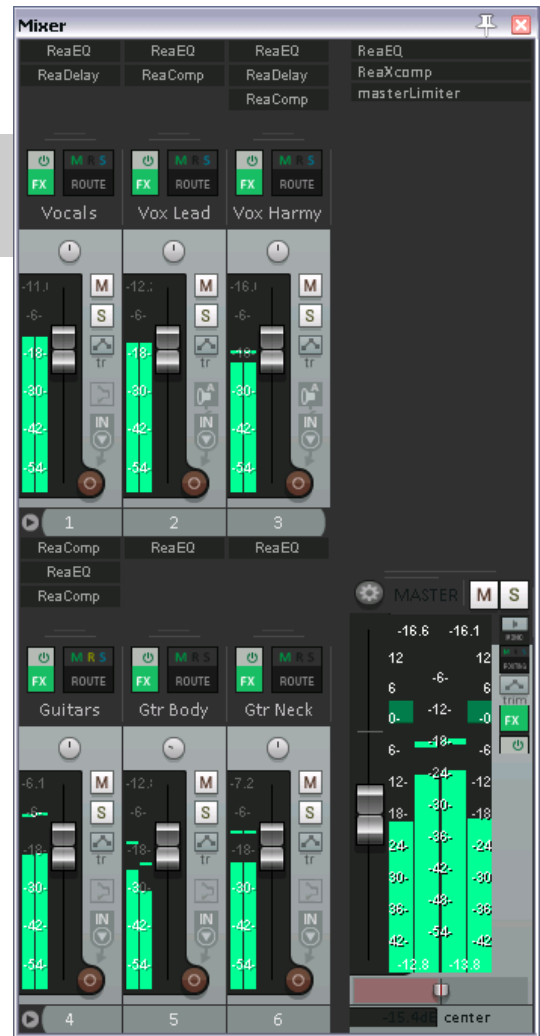

Making manual on-screen adjustments.

If, in the example here, you hover your mouse on the boundary between the FX area and the hidden sends area for any track, the mouse cursor will change to a double-headed arrow, as shown on the right. Finding the right spot can be a little tricky at first, so be patient.

You can then either click and drag up or down to drag the boundary up or down for that one track or hold **Ctrl** while you drag up or down to move the boundary for all tracks.

By holding **Ctrl** and dragging (in this case) up, we are able to make more room to display the sends as well as the FX inserts if we wish to, as shown in the second of these illustrations.



Up and Running: A REAPER User Guide v 5.24

In order to do this you do this
Adjust relative height of elements for the current track only.	Click/Drag up or down
Adjust relative height of elements for all selected tracks.	Alt Click/Drag up or down
Adjust relative height of elements for all track.	Ctrl Click/Drag up or down

Here we have adjusted the boundaries between the different elements (track controls and FX inserts) so as to make all of the FX visible. For example, Track 5 has no sends, but more space has been allocated to displaying the full list of track FX

We have then made some further manual adjustments - for example, the VU meter on the master has been made taller again by dragging up its top boundary.



Themes and mixer layouts.

REAPER's default theme includes many layouts, a sample of which are shown in this chapter. Listed below right are some of the layouts included with the REAPER 5 default theme. In addition, other themes are available, which have their own layouts. Themes can be downloaded from stash.reaper.fm and installed by dragging the .ReaperThemeZip file into REAPER's arrange view. Installed themes can be selected from the main menu, using the **Options, Themes** command.

Then, to choose a mixer layout for your tracks you can just do this:

1. Select the tracks whose layout you wish to change. For all tracks, just select one then press **Ctrl A**.
2. Right click over any selected track name then choose **Set track layout** then **Mixer Panel** then select from the menu. The layouts that you will see listed are attached to whichever theme you are using and may not be the same as those listed here.

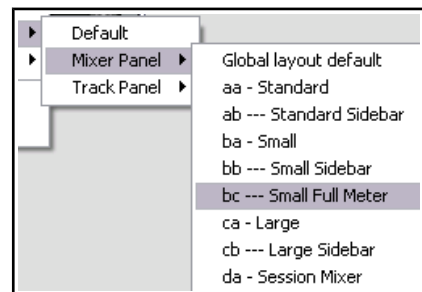

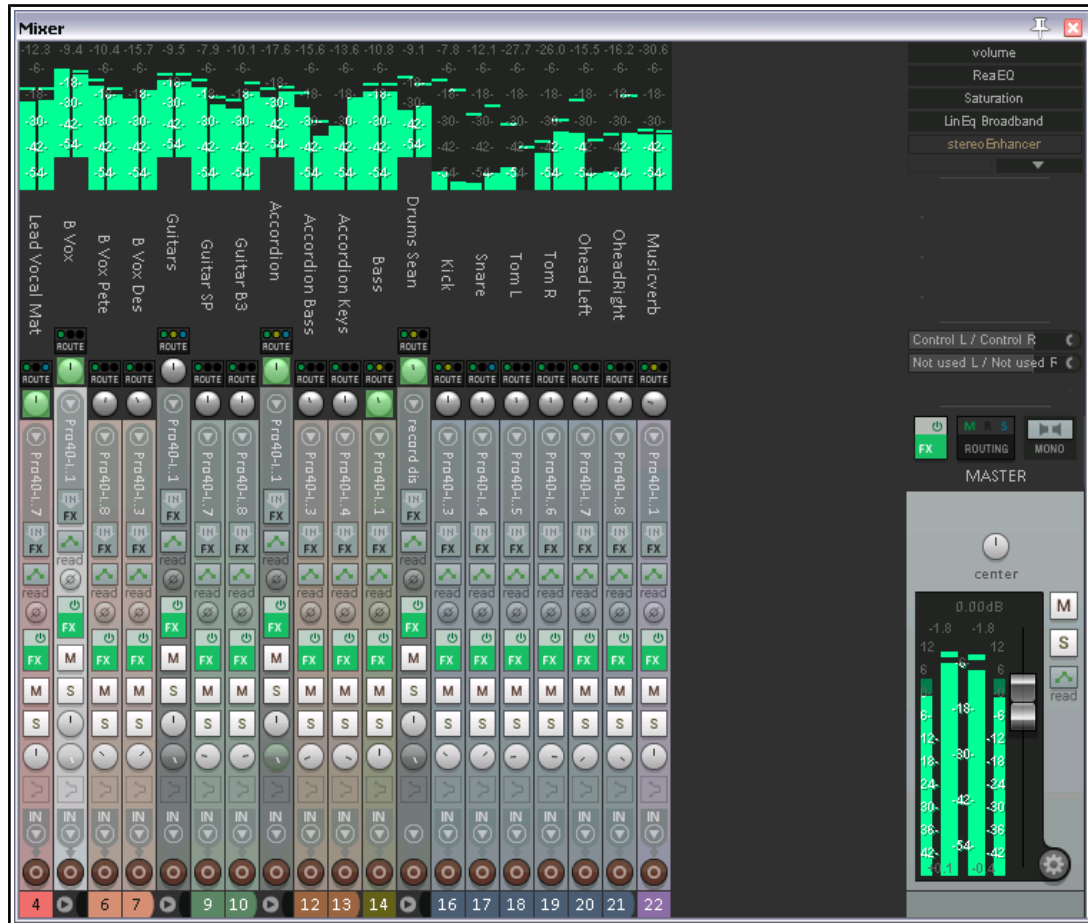

This is an example of another of the mixer layouts (Strip Full Controls) included with the REAPER 5 default theme. To browse thru, and download, the available REAPER themes go to <http://stash.reaper.fm/>. Sample screen shots of some of the other track and mixer layouts supplied with the REAPER 5 default theme are shown in Chapter 12.

11.10 Track Control Menus

The same functions that are available in the track control panels of your track view are generally also available in the mixer control panels. These functions are covered in detail in Section 2 of this User Guide. For example:

- Right clicking over the background area or Track Name for any track panel in the mixer displays the track context menu.
- Tracks can be armed in the Mixer for recording.
- Clicking on a track's ROUTING button displays the track's Routing Window. Right clicking on this button displays its routing menu.
- Clicking on a track's FX button displays the FX chain for that track. Right clicking on this button displays a context menu.
- Right clicking over a track's volume or pan fader causes the Volume Control or Pan Law window to be displayed.
- Similarly, the Record Arm, Record Monitoring and Select Record Mode buttons serve the same purposes as they do in Track View.
- Tracks can also be muted or soloed in the Mixer view. Both buttons use the same mouse modifiers and have the same context menus as they do in the TCP.

11.11 Introducing Windows Screen Sets

Windows screen sets can be used to save and recall complete on-screen layouts of your REAPER windows, including Arrange view, Mixer view, the Navigator, the Routing/Grouping matrix, and more. We'll examine their capabilities in more detail in Chapter 12, along with some examples in action.

Using Windows screen sets to save different combinations of Mixer settings can be a useful step towards fully understanding what screen sets are and how they work. They can be a great time saver, because the more you use REAPER, the more you will find yourself settling on perhaps three or four different layouts that you prefer for use in different circumstances. This will depend mainly on factors such as:

- **Number of Tracks:** your preferred mixer layout is likely to be different for a project with only three or four tracks from what it would be for a project with perhaps 20 or 30 tracks. For larger projects you are more likely to show multiple rows.
- **Project Stage:** the information that you would like to see in your Mixer may vary according, for example, to whether you are at the recording, early mixing or final tweaking stage of your project.

Windows screen sets are globally available in all projects. They are stored in a screensets.ini file in your \Application Data\REAPER folder. This means that you can use any project to create a screen set, and then use that same screen set with any other project. You should find the following summary information useful.

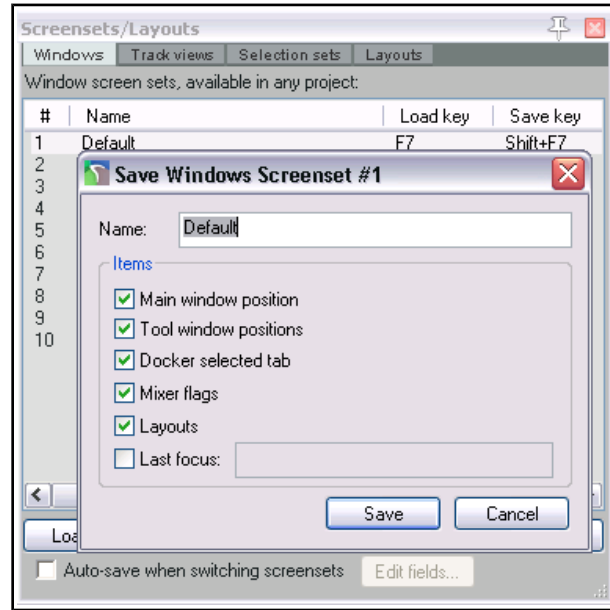

In order to do this you do this
Create a Windows Screen Set	<p>Arrange your Windows, including the Mixer and its various options and settings, on screen, exactly as you want it.</p> <p>Choose the View Screensets/Layouts command (Ctrl E).</p> <p>Select the Windows tab.</p> <p>Click on any item number to select it, then on Save to open the Save Windows Screenset window (see above).</p> <p>Select as many options as you require, e.g. Main window position, Tool window positions (ie. all other windows), Docked selected tab, Mixer flags (i.e. whether inserts, sends, FX, etc are visible), Layouts, Last focus (currently focussed window).</p> <p>Click on Save.</p> <p>You can accept any default shortcut Load key that is shown (e.g. F7 for windows screen set #1) or click on Edit shortcuts to open the Actions List Editor and assign your own. The Actions List is explained in Chapter 15.</p>
Load/Recall a Windows Screen Set	<p>Either use the keyboard shortcut (where one exists), <i>or</i></p> <p>Choose the View Screensets/Layouts command (Ctrl E).</p> <p>Select the Windows tab and double-click on the required screen set name.</p>

11.12 Mixer Appearance Preferences

REAPER's Preferences window does not have a section specifically labelled Mixer, but there are several places where your choices will affect the Mixer and its appearance.

One of these is the **Theme development/tweaker window**, accessible from the action list editor. Choose the **Actions, Show action list** command, enter *theme* in the filter window then select and **Run** the action **Theme development: Show theme tweak/configuration window**. The action list editor is explained in depth in Chapter 15.

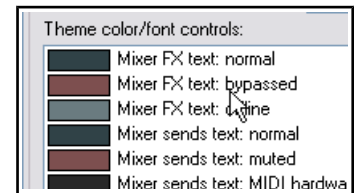

Click on any element name in the displayed list, choose a new color from the color picker window and click on **OK**. Use the **Save Theme...** button if you want to save your changes.

- | | |
|--------------------------------------|--|
| Mixer FX text normal color | Mixer FX knob text offline color |
| Mixer FX text bypassed color | Whether you want the VU meters to be interlaced. |
| Mixer FX text offline color | VU meter clip indicator color |
| Mixer sends text normal color | VU meter top color |
| Mixer sends text muted color | VU meter middle color |
| Mixer sends text MIDI hardware color | VU meter bottom color |
| Mixer sends level color | VU meter interlace/edge color |
| Mixer FX knob text normal color | VU meter show MIDI activity |
| Mixer FX knob text bypassed color | |

Under **Options, Preferences, Appearance, Track Control Panels** you will find a couple of options that you might be able to use to customize your mixer appearance by the use of color coding. Control of these options is disabled by the some color themes (including the default, which locks these options on). These are to **Set track label background to custom track colors** and to **Tint track panel backgrounds**. Any colors selected using the context menu **Custom track colors** command (see Chapter 5) will be applied to the track panels in your Mixer. Shown below is an example with custom colors applied and using the settings of the default theme.

If you wish to be able to change these and various media item coloring preference options, one way is to use a theme that allows this. An example (which in most respects closely resembles the default theme) can be found at <http://stash.reaper.fm/theme/1621/Default%205.0%20Nitpicky%20Edition>.

One final preference setting to note is the **Show in mixer** option under **Project, Track/Send Defaults**. By default, this option is enabled, which means that new tracks as they are added are automatically shown in the Mixer. You should disable this preference if you wish to change this default behavior. This setting can be overridden for individual tracks using the Track Manager. This is explained in Chapter 12.



11.13 Stereo and Dual Panning

The stereo panner and the dual panner are designed to give you more control over how you pan stereo tracks. The default pan law (stereo balance/mono pan) gives you a single pan control which moves the sound between the left and right speakers.

However, a stereo track is made up of two channels – left and right. You can see these on any stereo wave file that you record or import into any project. The output of one channel (the top waveform) is normally routed 100% left, the other (bottom waveform) 100% right. Using the dual panner or the width panner you are able to change this in one of two different ways.



The dual panner (shown below right)) is easier to understand. Each of the two pan controls contains one of the channels. Pan the first of these 100% left and the second 100% right and you will hear the first channel thru the left speaker only and the second thru the right speaker only. Reverse these and you will now hear the first channel only thru the right speaker and the second only thru the left channel. Pan both fully left and you will hear both thru the left speaker only. You can adjust both pan controls independently to place each channel exactly where you want it. For example, if you set both controls dead center you will hear exactly the same mix of the two channels thru both speakers.

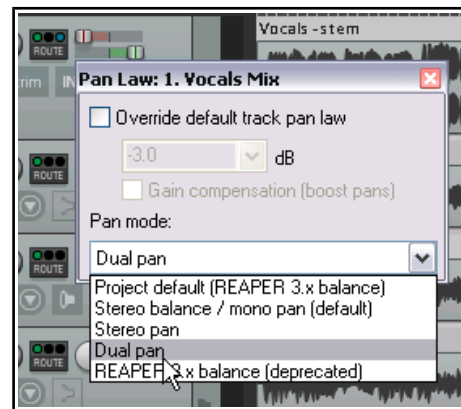

The stereo panner is in some respects more subtle. You can use the width control to adjust the mix of the two individual channels of a stereo media item, folder or submix, and the balance panner to position that overall mix further to the left or the right.

To help you understand this, let's work thru a relatively simple demonstration.

Displaying the Dual Panner or Stereo Panner

Any track's dual or stereo panner can be shown by right-clicking over the pan fader and selecting the required pan mode. You are most likely to want to do this for a track which contains stereo media items, or which is a folder, or acts as a bus or submix.

Example

In this example we will first create a stereo file in order to help us experiment with the use of the width panner. We will then get a little more ambitious and use it on a submix. This will include rendering the mono media items on two current tracks a single stereo file. The topic of rendering will be covered in detail in Chapter 21.

1. Open the file **All Through the Night.RPP** and save it as **All Through the Night WIDTH.RPP**.
2. Mute all tracks except the Guitar Body and the Bouzouki.
3. Pan the Guitar Body 100% left and the Bouzouki 100% right.
4. Choose the **Render** command from the **File** menu. Make sure that you set Channels to **Stereo**, and select **Master mix** and **Entire project**. Select output format MP3 and **Add rendered items to new tracks in project** (see next page).
5. Click on **Render 1 File**.
6. After a few seconds, the rendered file will be added as a new track. Give the track a suitable name. It should resemble that shown here.

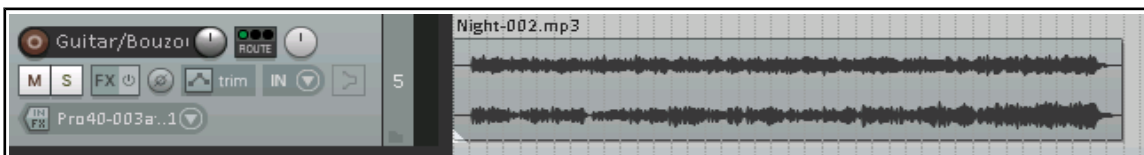

7. In this rendered track, the guitar makes up the audio on one channel, the bouzouki on the other channel.

8. **Solo** and play this track.
9. Adjust the pan control slowly, first fully left, then fully right, then back to the center. As you do so, one channel will gradually fade away. Panned full left you will hear only the guitar, full right only the bouzouki. Move the pan back to the center.
10. Selected this track in the TCP, right click over the pan control and choose **Dual Pan** option from the pan mode drop down list (explained overleaf).
11. Play the song. Slowly move the top pan control to 100% right. You will hear both instruments in the right speaker only.
12. Move the lower pan control to 100% left. Now you will hear the guitar in the right channel only, the bouzouki in the left channel only – the opposite of what you started with.
13. Experiment moving these faders. When finished, move the top pan control to 100% left and the lower pan control to 100% right. Save the file.
14. Now change the pan mode for this track to **Stereo Pan**.
15. Play the song. At first you will hear only the guitar in the left speaker, only the bouzouki in the right speaker. Slowly move the lower (width) panner from 100% right towards the centre (0W). As you do so, the two instruments will tend to blend more together.
16. With width set at 0W, move the top (pan) control fully left. The mix will now be heard thru one speaker only. Move it back to the center. Save the file.

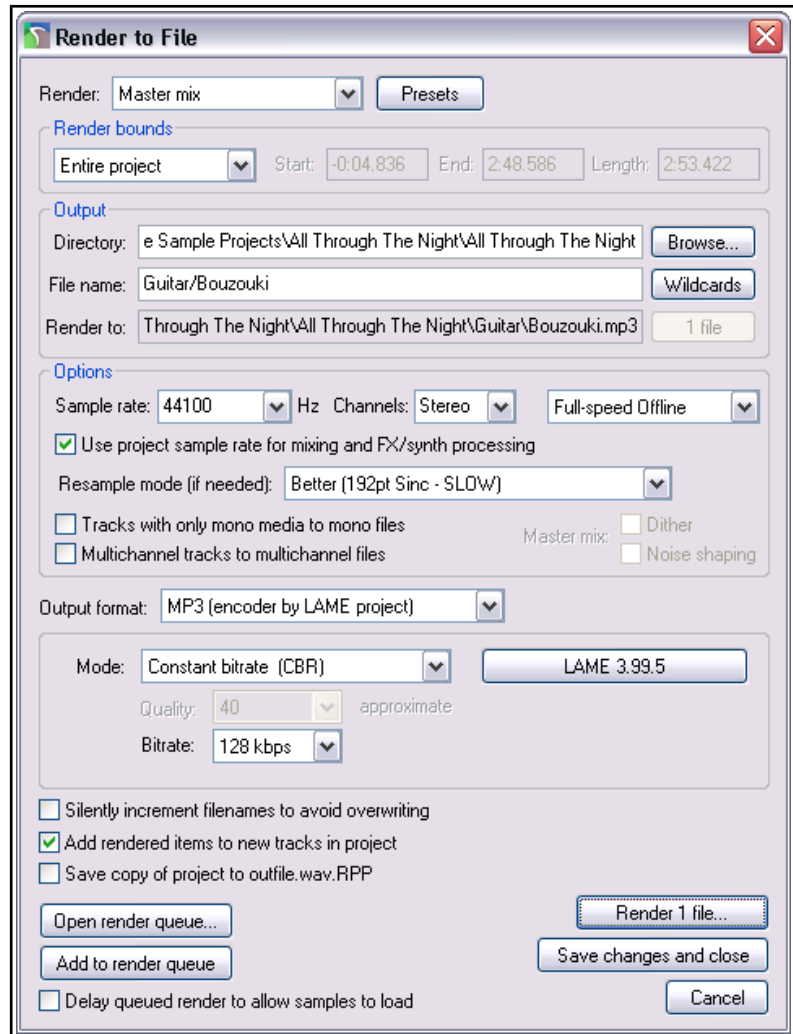

Now try this:

1. Unsolo and mute the stereo track.
2. Create a folder called Instruments just after the Vocal track. Select Stereo pan mode for this folder.
3. Make the two guitar tracks and the bouzouki tracks child tracks of this folder. Adjust the volumes and pan settings of the individual tracks and the folder to get a nice mix. Pan the different tracks well apart.
4. Use the width control on the folder. Experiment with using this to bring the instruments closer together or further apart. Use the pan control to position the overall mix further left or right. You can still adjust pan settings for individual child tracks within the folder as well if you wish.

Tip: This technique can do wonders when you are mixing vocals, including vocal duets and vocal harmonies!

Pan Modes

By default, the stereo width is applied before the pan/balance control. To select a different pan mode, right-click over either the pan or width control fader and choose from the drop down list. The three modes are:

Stereo Balance/Mono Pan: The track is treated as mono, even if it contains stereo media. Set to center, you hear the same signal equally thru both speakers. Set hard right, you hear it in the right speaker only.

Up and Running: A REAPER User Guide v 5.24

Stereo Pan Lets you control side (pan) and width separately. Side means that the stereo image is set more to the left or right, and width means how far apart the left and right channel are in the stereo image. With side set to center and width set to 100%, you hear the left channel in the left speaker and the right channel in the right speaker. With side set to center and width set to 0%, you hear both channels equally in the left and right speakers. With side set hard right, you hear both channels equally in the right speaker, regardless of the width setting.

Dual Pan: Lets you control both channels separately. The left knob sets the left channel more left or right, the right knob sets the right channel more left or right. With left set hard left and right set hard right, you hear the left channel in the left speaker and the right channel in the right speaker. With left and right both set to center, you hear both channels equally in the left and right speakers. With left and right both set hard right, you hear both channels equally in the right speaker. It is recommended that you do not use the deprecated Reaper 3 pan mode. This has only been left as an option to ensure that older Reaper 3 projects which may have used this mode do not become broken.

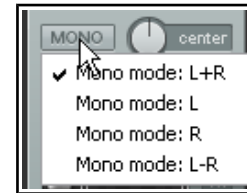
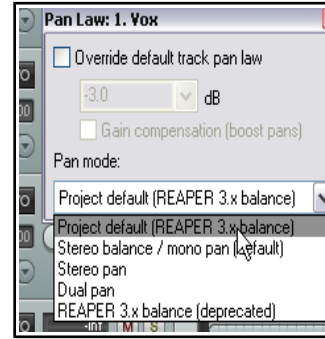

11.14 Master Track Options and Settings

The mixer Master Track controls has the same functions as when the Master Track when shown in Track View. Note the Output button (above - by default labelled Mono):

- Left click on the Output button to toggle between Stereo and Mono modes.
- Right click on the Output button to set any one of four available Mono modes (above right).
- Left click on the FX button to display the master FX Chain.
- Right click on the FX button for the Add FX context menu.
- If the FX chain for the Master is displayed, then you can use all and any of the FX management keyboard shortcuts that you can use on your tracks.
- Right click over the VU area to display the settings that you can use to control what is displayed in the VU and how it is displayed (above right).
- This includes the option to display output in multichannel mode (e.g. when working with surround sound). Disabling this option will ensure a two channel display.

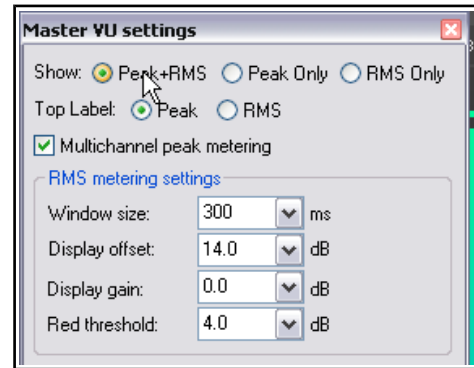

11.15 Master Hardware Outputs

Output from the master can be directed to one or more of your available hardware outputs. This can be done using the routing matrix. The master routing button (in the Mixer) can also be used to set up and manage your hardware output or outputs.

- Right click on the ROUTING button to display a menu of hardware output options. These can be toggled on and off in any permutation that you require.
- Left Click on the ROUTING button to display the master track outputs window. This can be used to control the levels and panning of the signals to the hardware outputs.

Notice (below) that for each output you can independently control any or all of the following:

- | | |
|---------------------|-----------------------|
| Toggle Mute on/off. | Toggle phase invert. |
| Set Volume level. | Set panning position. |

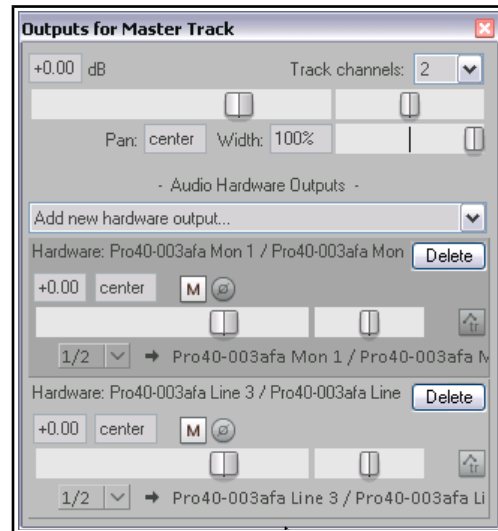

11.16 Master Track Channels

The topic of routing and channel splitting is one that recurs throughout this user guide. The concept itself starts as a relatively simple one, but from those simple beginnings it can grow into something as complex and as complicated as you like. You'll find no shortage of examples in Chapter 17.

You can use channels to send two copies of the same signal to two different places. You can then do separate things to each signal before joining them up again. Below is a relatively simple example. The example itself may or may not be something that you'll ever want to do, but that's not the point. The point is that it will help you to understand what channel splitting is about and how to do it.

Let's take an example of using multiple channels (two stereo pairs in fact) for our master. We can use this to feed some effect (such as reverb) into our signal chain, then send the effect (and only the effect) out to our headphones (to enable us to assess it), while sending the overall final mix to our speakers. In order to work thru this example, you will need a sound card with at least four audio outputs.

Example

This exercise will almost certainly be too complex for the novice user, and as such is recommended for the more experienced only. Otherwise, you might wish to return to it after you have completed Chapter 17.

This diagram shows what we are going to achieve. It assumes that our audio signal flows from left to right.

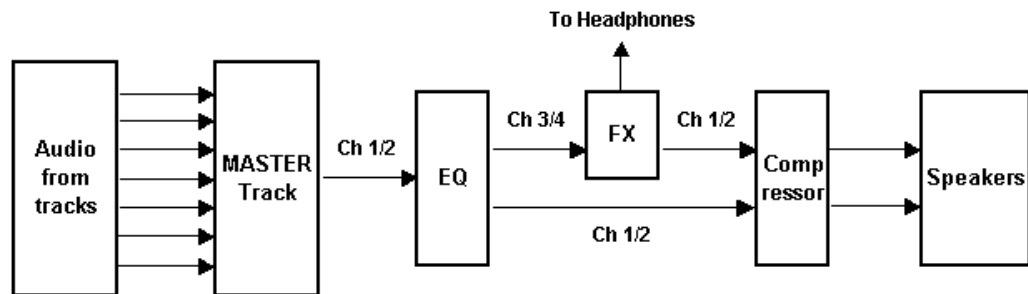

First we will create the

necessary extra Channels for the Master Track.

The audio coming into our Master from the mix will be split between Channels 1/2 and Channels 3/4. The signal that is passed to Channels 3/4 will be fed thru a Reverb plug-in then directly out to our headphones. It will also be passed back into a Compressor plug-in, where it will be mixed back into the original incoming signal. The final mix will then be fed to the speakers.

1. Open the file **All Through The Night.rpp** and save it as **All Through The Night MASTER.RPP**.
2. Pan the two guitar tracks roughly 40% left and 40% right respectively. Pan the Bouzouki about 15% left, the Vox around 10% right. Quickly adjust the volume levels for each track to suit, especially to avoid clipping in the Master. Save the file.
3. View the Mixer and enable the options to **Show FX inserts when size permits** and **Show sends when size permits**.
4. Make sure your Speakers and Headphones are each connected to different paired sound card outputs.
5. Right click over the **ROUTING** button in the Master and make sure that output is directed both to your speakers and to your headphone amp.
6. To create the required channels, left click on the **ROUTING** button for the **Master Track** and set the number of channels to 4 (as shown, right).
7. Assign the output of channels 1/2 to your studio speakers and 3/4 to your headphones. Your settings should appear similar, but of course not identical, to those shown here.

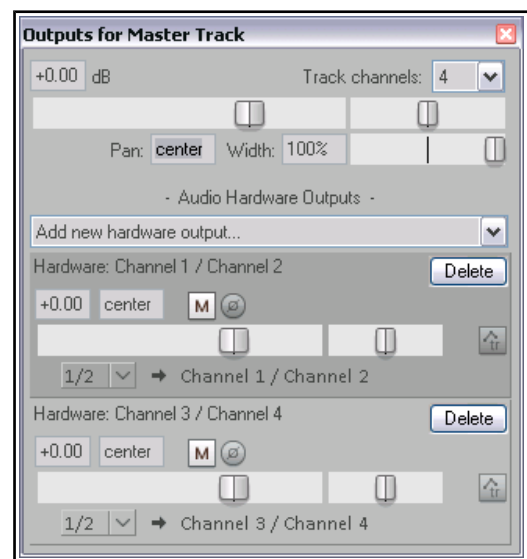

Up and Running: A REAPER User Guide v 5.24

- Play the song. For now, it should be heard over the speakers, but your headphones should still be silent.
- In the Master FX chain, add the plug-in **ReaEQ** and, for the purpose of this exercise, add a 2 dB gain on Band 2, a 1 dB drop on Band 3, and a 1dB gain on Band 4.
- In the Master FX chain, click just below the ReaEQ and add **ReaVerbate**. Leave the parameters at their default settings, but adjust the outputs from this plug-in so that they are directed left and right respectively to channels 3 and 4 only. The settings for these outputs are shown (right).
- Now play the song. The playback thru the speakers will include the effects of your **ReaEQ** settings but not **ReaVerbate**. In contrast, if you listen thru the headphones, you will hear only the reverb.
- Now click again in the master FX chain and add **ReaComp** after the reverb plug-in. Adjust the Input Settings for this plug-in so that Channels 1 and 3 are the Main Input for the left, and channels 2 and 4 are the Main Input for the right, as illustrated below right.
- Play the song. You can adjust the amount of reverb in the mix by adjusting the vertical **Wet** and **Dry** faders in the **ReaVerbate** window. You can also adjust the **Threshold** (vertical fader on the left) and **Ratio** settings for **ReaComp** if you wish.
- Your speakers will now play the output signal from your Master Track's FX chain, including the reverb mixed in. Your headphones will still play only the direct output of the **ReaVerbate** plug-in.
- Save this file.

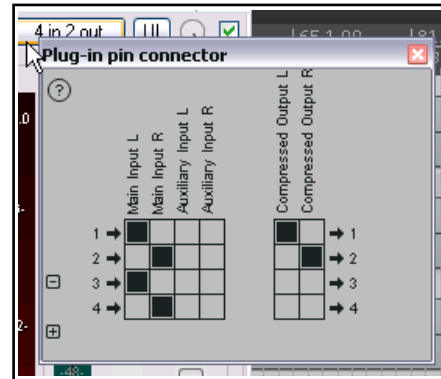
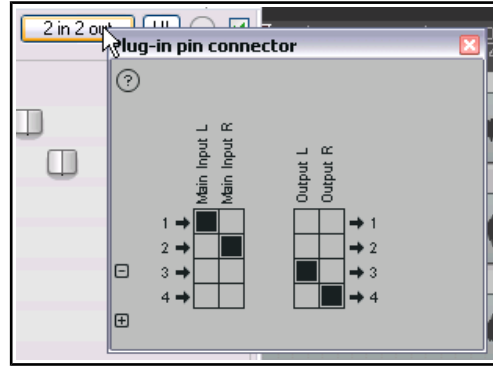

11.17 Avoiding Channel Leakage

You need to be aware when you are using multiple channels for the Master Track that any signal routed along any channels between tracks will also be sent to the Master. For example, you might be using channels 3/4 in one or more of your tracks for some other purpose. In that case, if you also used channels 3/4 for the purpose outlined in the above example, then the signal on channels 3/4 of your tracks would also be leaked into the signal being fed to your reverb plug-in.

This channel leakage can be avoided simply by reserving for the Master a pair or pairs of channels not used elsewhere in the project – in this example, you might choose to use Channels 5/6 or Channels 11/12. Since you have up to 64 channels available to you, this should not normally present you with any problem.

11.18 Reset VU Meter Peaks

Notice that during playback, your VU meters in both track view and mixer view will display the peak level recorded for each individual track (see right). To reset the peak reading for any individual track, click your mouse over the area where the peak value is displayed.

To reset the peak reading for all tracks, hold the **Ctrl** key while you click your mouse over the area where the peak value is displayed in any one track.

You can also if you wish disable the option under **Options, Preferences, Appearance, VU Meters/Faders** to **Reset meter peak indicators on play/seek**. If you do this, the current peak levels will be remembered even when you stop playback. When you resume playback, they will be retained as the peak levels until, of course, a louder passage is encountered.



12 Project Management Features

12.1 Introduction

In this chapter we'll be looking primarily at some of those features of REAPER which you are more likely to want to use when you are managing your project as a whole rather than just focussing on individual tracks or items. These include using the Project Media/FX bay, Locking, modifying a color scheme, using the Track Manager, Screen Sets and more. We'll start by looking at how you can change a project's start time.

Note: Some of the illustrations in this chapter use REAPER 4 theme and colors. The information and instructions, however, are valid for REAPER 5.

12.2 Setting the Project Start Time

With many projects you will find that you have a few seconds of recorded silence before the program material (instruments and vocals) actually start. This can create two annoying problems:

- Times shown on the timeline and on the big clock do not accurately represent the time within the song.
- When you go to the start of the project, there are always a few seconds of silence to be played before you reach the start of the song.

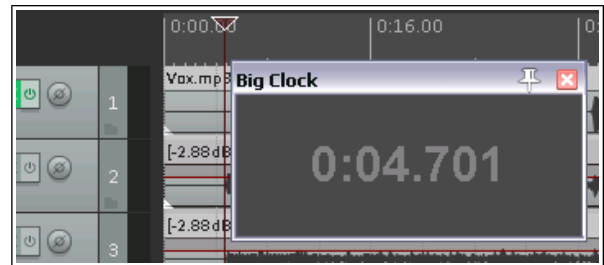

In the example shown above the actual start of the song is at 0:04.701. We want to reset this point to Zero. This is how it is done:

- Place the cursor at the point that you wish to mark as the start of the song - in the example shown this will be 04.607 into the project.
- Press **Alt Enter** to display the **Project Settings** window.
- Select the tab labelled **Project Settings**.
- Click the button labelled **Use Cursor** (see right). REAPER will automatically enter the correct position into the **Project start time** box for you.
- Click on **OK** to close the Project Settings interface.
- If you wish to mark this point, press the letter **M** on your keyboard. This creates a marker on your timeline labelled **1**.
- If you need to refresh your understanding of markers, look back thru Chapter 9.
- The position of the marker is now set to **0:00.000** and you can jump straight to this point at any time by pressing **1** on your keyboard (see right).
- If you wish, you can double-click on the marker to open up the **Edit marker** dialog box, where you can give it a name.

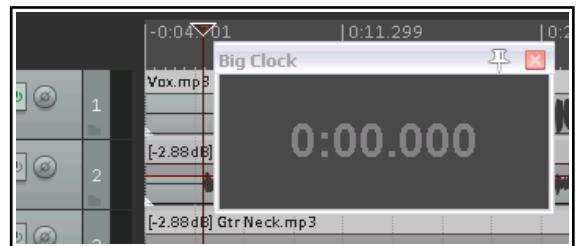
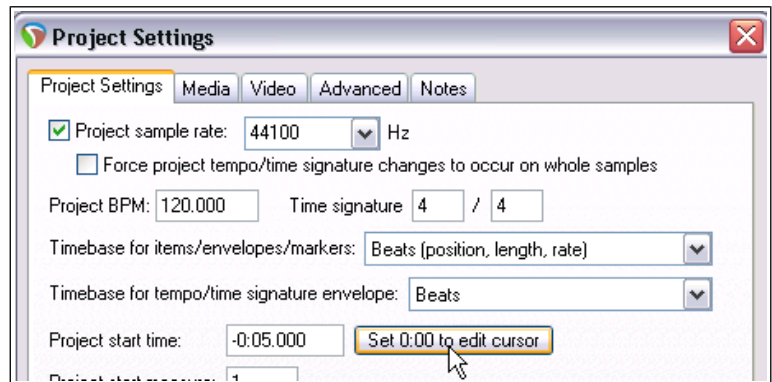

12.3 Locking Media Items

Individual items can be locked into position to prevent their settings from being accidentally changed, such as by being moved or deleted, while at the same time leaving you free to manipulate other items as you wish.

To make use of this feature, first ensure that both of the item icons **Locked** and **Not locked** are selected (along with any other item icons that you wish to use) under your **Options, Preferences, Appearance, Media** settings (see above). Whether the icons are

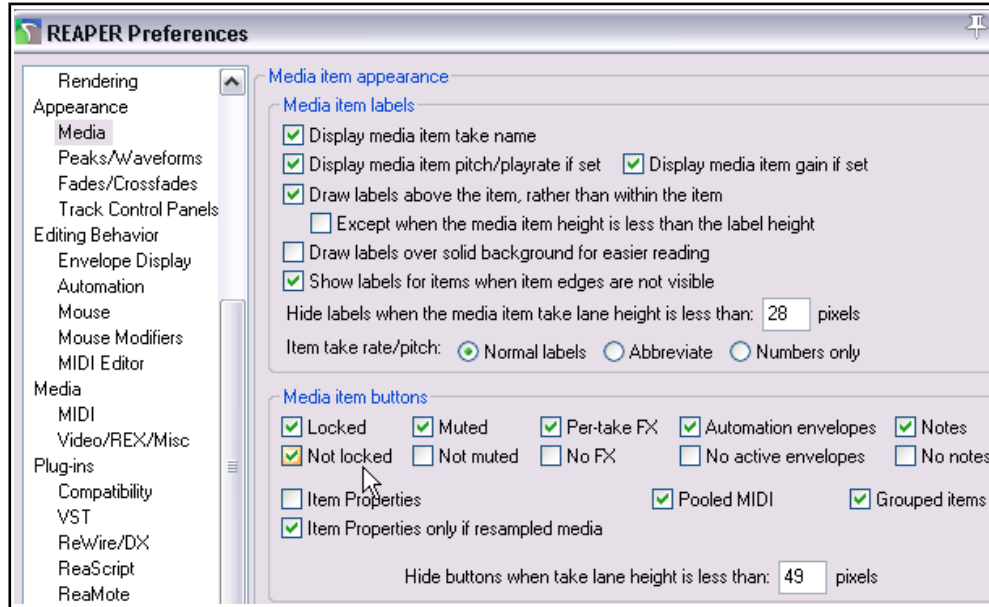

displayed on top of the media items or in a lane above it (as in the example below) will depend on whether you have enabled the option **Draw item labels above rather than within the item**.

Locking for individual media items is then toggled on and off by clicking on the small padlock icon that will be visible at the top left corner of the media item.



The example above shows a track with two media items. The first item has been locked (notice the dark padlock icon). It can now not be deleted or moved, unless its status is set to unlock. Similarly, you cannot grab the handle across the top of the media item and drag it down to adjust its volume, nor can you add a fade in or fade out, nor can it be slip-edited.

You can, however, make changes to most of its settings within the Item Properties dialog box (pitch, play rate, FX Chain, and so on) or using the media item context menu. The second item, however, remains unlocked (notice the open padlock icon). It can (for example) be moved, or deleted, or have a fade out added. You can also open the item for editing, in the MIDI editor (MIDI items) or your installed external editor (audio items). Locking and unlocking can also be performed with multiple items. To lock a number of items, simply hold the **Ctrl** key while you click on each item in turn to build the selection, then click on the padlock for any item included in the selection.

12.4 Locking Track Controls

The toggle command **Lock Track Controls** (from the track control panel right-click context menu) can be used to lock/unlock the controls for any track or selection of tracks. This prevents you from making accidental changes to any of the track's controls (e.g. Volume or Pan). In the example shown, track controls have been locked.



You can hover your mouse over the control of a locked track to see its current setting displayed as a tool tip.

12.5 Project Lock Settings

The Locking feature of REAPER can be used to effectively freeze certain aspects of a project file to prevent something accidentally being changed or deleted. There are two aspects to locking:

- Deciding which project elements you would like to be locked.
- Enabling or disabling the locking feature. The keyboard shortcut **L** can be used to toggle this on and off.

To display the Lock Settings window (shown right), press **Shift L** or right click over the lock button (the last item) on the toolbar. The table below summarises some of the ways in which you are able to make use of this feature. Select which ones you wish to lock, then **Enable locking** to actually lock them.

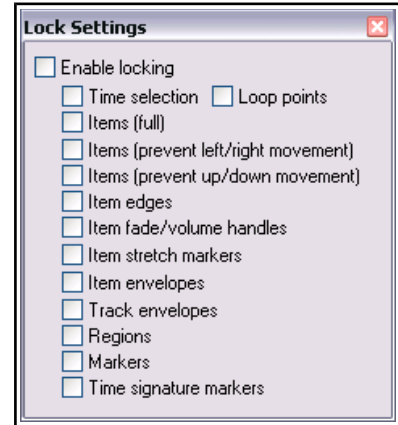

Locking Option	Comment
Time selection	This locks the current time selection so that, for example, if you accidentally click and drag at some other point along the timeline your time selection will remain unchanged. You can remove a locked time selection by pressing Esc then selecting Yes when prompted.
Loop points	Locks currently selected loop points.
Items full	This option prevents you from making any changes at all to any of your existing media items. For example, you cannot mute them, add FX to them, delete them, move them, slip edit them, or even access the Item Properties window or right click menu for any of your items.
Items (prevent left/right movement)	This option allows you to make any other changes you like to your media items except move them left or right.
Items (prevent up/down movement)	This option allows you to make any other changes you like to your media items except move them up or down.
Item edges	This option disables actions such as slip editing.
Item fade/volume handles	This option can be used to prevent any adjustments being made to any item's volume handle or rotary fade controls.
Item stretch markers	This option can be used to prevent any changes or movement from occurring to any item's stretch markers.
Item envelopes Track envelopes	This option ensures that when locking is enabled you will not be able to make any changes to existing item and/or track envelopes. For example, you will not be able to move or add points, or change shapes. You will still be able to add new envelopes for faders and plug-in parameters, but you will not be able to edit these in any way. For more about envelopes see Chapter 18.
Regions	Locking regions prevents you from changing (for example by moving, deleting or renaming) existing regions. However, you will be able to create new regions with Lock Regions enabled.
Markers	Locking markers prevents you from changing (for example by moving, deleting or renaming) existing markers. However, you will be able to create new markers with Lock Markers enabled.
Time Signature Markers	Locks time signature markers and prevents them from being modified.

Example

Let's suppose that we are happy with the way our media items line up, and we don't want any of them being accidentally nudged or moved to the left or right. You might then wish to lock their horizontal position.

1. Press **Shift L** to open the Locking Settings window.
2. Tick only **Items (prevent left/right movement)**.
3. If **Enable Locking** is not enabled, click on it to turn it on.
4. Now try to drag and drop any of your items to the left or right. They won't move.
5. Press the **L** key – this toggles locking off again.

12.6 Customizing Colors and Fonts

Chapter 15 of this User Guide covers REAPER's action list editor. One action that you might find useful is the action **Theme development:**

Show theme tweak/configuration window

This is selected after choosing the **Actions, Show action list...** command. Enter *theme* in the filter window then select and **Run** the action **Theme development: Show theme tweak/configuration window**.

Themes consist primarily of three types of materials: image files, color/font definitions and Windows settings. The image files provide, for example, the track control items and media item icons (pan and volume faders, mute and solo controls, etc.).

The definitions apply to items such as the font used for track names and the colors used for media items, track and mixer panels, edit and play cursors, markers, VU meters, envelopes, and so on. If you are not sure what any of the listed items are, you can use the **Theme element** finder to identify them (see below). To display this,

Eter *theme* in the action list filter window then select and **Run** the action **Theme development: Show theme element finder**.

In addition to those installed with REAPER, many themes are available for download from stash.reaper.fm. To install a downloaded .ReaThemeZip file, drag and drop it from Windows Explorer into REAPER's Arrange View (main view).

The **Load Theme ...** button (in the theme development/tweaker dialog) can be used to select any available theme. Scroll thru the **Theme color/font settings** list to see all of the items which you can change. Click on any item to open (as appropriate) the color picker or font dialog box, where you can change its definition.

Finally, having chosen your fonts and colors, you can save them all together into a new theme by clicking the **Save theme...** button and giving your theme a name.

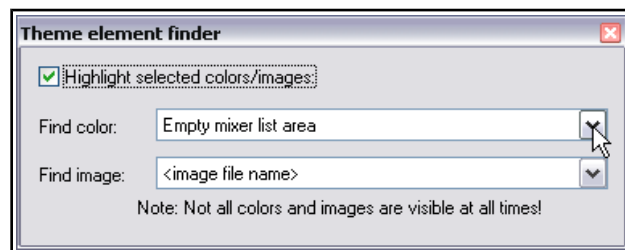
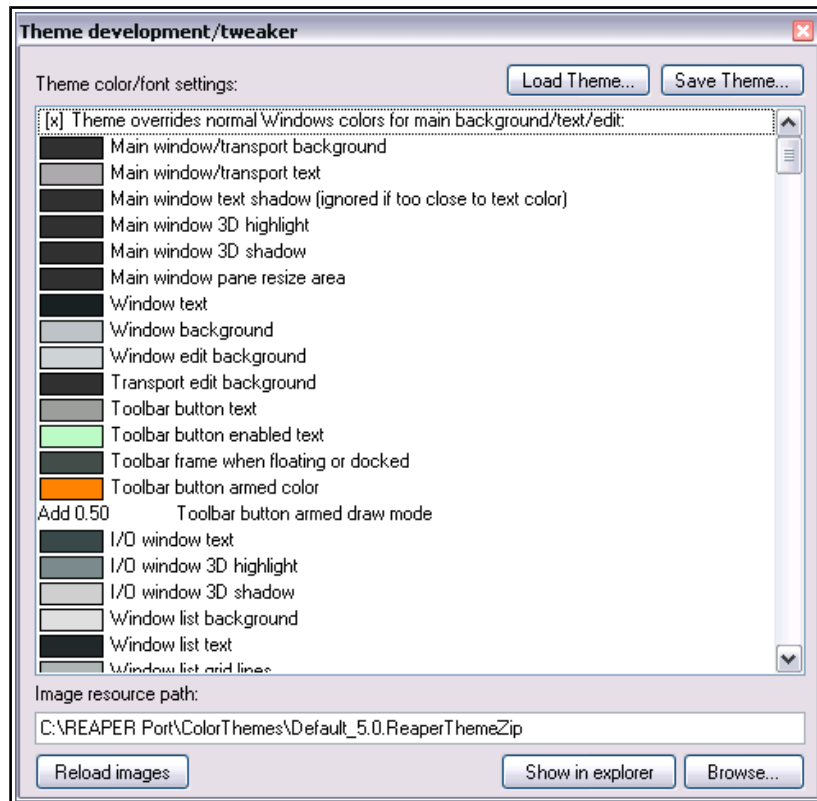

12.7 The Project Media/FX Bay

Overview

The **Project Media/FX Bay** is a one stop center which you can use for managing and arranging a project's FX and media items. It is opened from the main menu by the **View, Project Media/FX Bay** command. The window contains five tabs (pages). The Item Groups (Chapter 7) and Take Comps (Chapter 8) tabs have already been introduced. The other three are:

- ◆ **Source Media.** This lists the media items that are available for use in, or are already used in, the project. Each item will occur only once in this list. Where it is used more than once in the project, this will be indicated by the number in the Usage column.
- ◆ **Media Items.** This lists only the items that are actually used in the project (i.e., active). An item will appear in this list as many times as it is used in the project.
- ◆ **FX.** This lists the FX plug-ins that are used in the project.

You can drag media files (e.g., from REAPER's Media Explorer or from Windows Explorer) or FX (e.g., from the FX browser) into the Project Bay. Media items inserted in this way are added to the **Source Media** page. If the item is then used in the project, it will be added to the **Media Items** page. FX items are added to the FX bay. You can rename items within the Project Bay, select all instances of a media file or FX within the project, and replace media/FX in the project with any other media/FX from the Project Bay. You can also mute/solo media items and bypass/unbypass FX.

Both Media pages and the FX page include a Retain column. When you drag media items or FX into the project bay, they are marked with a + in the retain column. This setting means that the entry will remain in the project bay even if there are no instances of that media item or FX in the project.

When you add media (by recording or inserting) to the project, they will appear as entries in the media items and source media bays, with the retain status unset. These entries will be automatically removed from the project bay if they are removed from the project itself. If you want the entries to remain in the project bay even after being removed from the project, you should enable retain for those entries in the source media bay.

FX entries in the project bay include a **Preset** column. If you change the value in this column (from the right-click menu), all instances of that FX in the project with the previous preset selected will be changed to the new preset. In addition, you can retain an FX entry with a specific preset, or multiple entries for the same FX with different presets, in the project bay.

The Project Bay includes the buttons **Actions** and **Options**. Clicking on either of these displays a menu. As an example, the **Options** menu is shown on the right. Most of these commands require little explanation.

Mirror selection in bay and project. When enabled, this causes an item selected in the project to also be selected in the bay, and vice versa. You can also ensure that REAPER will **zoom to a selected item** when this option is enabled.

Use last selected item as source for "draw a copy" mouse action. This enables you to use pencil mode to create copies of the last selected item.

Space bar previews media allows use of the spacebar to play the currently selected media or source media item. **Loop media preview** will allow any loop marked in the project to be applied. **Preview** (source or media items) **through selected track** allows you to play back the item with, for example, any FX in a particular track's FX chain, or any track envelopes, being applied. The **Filter** can be set to use name, path or comment.

Make sure the option **Clear bay when changing projects** is enabled if you wish to make each Project Bay project specific. Disable it if you want to carry over items in the current bay to the next project that you open or create. You also have the option to **Automatically retain media items when they are removed from project.** This ensures that retain status is automatically assigned when an item is removed from the project.

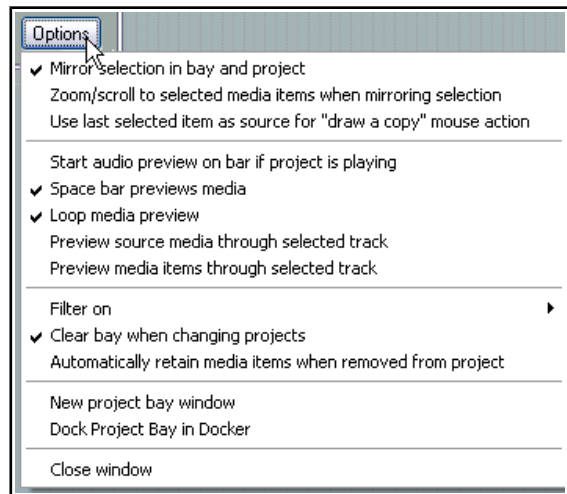

Up and Running: A REAPER User Guide v 5.24

The **Dock project bay** and **Close window** commands are self-explanatory.

The commands on the **Actions** are shown right. They can be used with and applied to the items (media or FX) on whichever bay page is currently selected.

New project bay window opens a new project bay window. You can then use this (for example) to load a different saved project bay, whilst keeping the original bay open in the original window.

Create new folder. Individual project bay entries can be dragged and dropped in or out of the folder (see example below, where two folders have been created, Bells and Strings). Folders can be used for source media items (as shown below), Media Items (in project) or FX. Double click left of the folder name to collapse or expand the folder.

Force refresh forces a refresh of the project bay display.

Select all items causes all items in the current tab to be selected.

Retain all items causes all items in the current tab to be marked to be retained in the bay even when they are deleted from the project.

Remove all items from project will remove all items from the project, and **Remove all items that are not used in project** will remove from the media bay all items that are not used in the project.

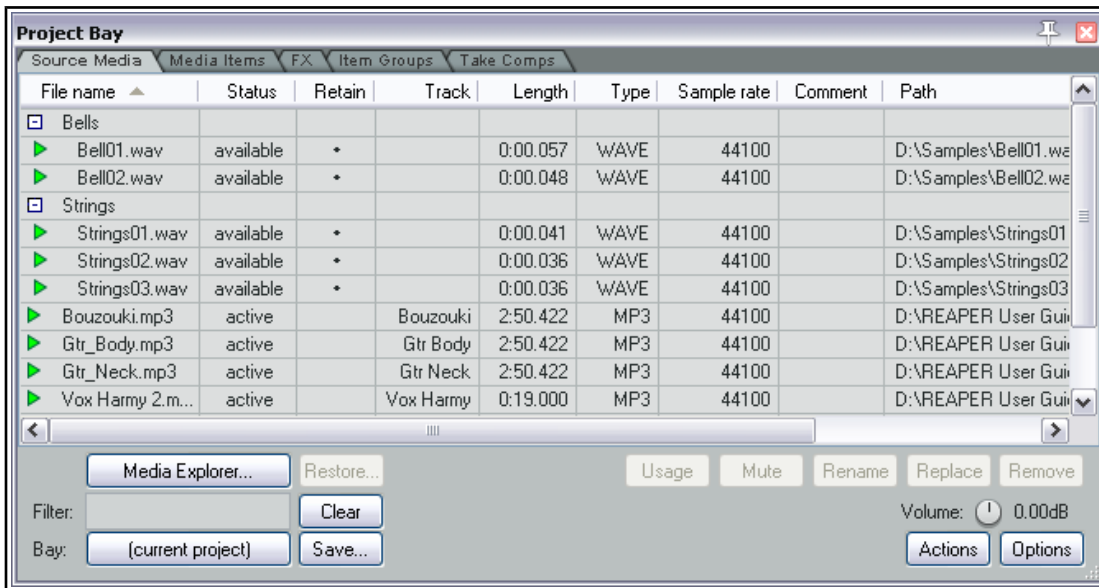
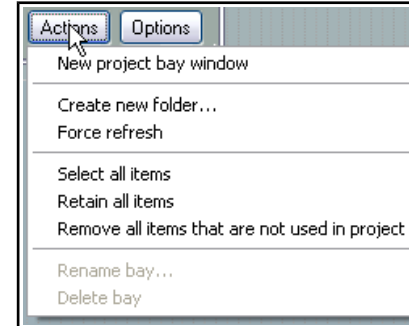

The **Media Explorer** button (lower left) can be used to open the Media Explorer, from where media items can be dragged and dropped into the project bay (as source media) or into the project itself.

The rotary **Volume** control can be used to control the volume of any item being previewed when the option to preview thru selected track has been disabled.

The **Bay** button (bottom left) serves three basic functions. You can use it to create a new project bay, to replace the contents of the current bay with a previously saved one, or to merge the contents of a previously saved project bay into the current one.

The Source Media Bay and the Media Items Bay

The techniques for working with media items in both of these bays are very similar. The main differences are:

- ◆ Items dragged into the Bay are placed in the Source Media Bay only, until such time as they are actually added to the project. They are then automatically also listed in the Media Items bay.
- ◆ Only items which are active (and therefore included in the project) are shown in the Media Items Bay.
- ◆ Active items can be managed from either of these bays. Available items can only be managed from the Source Media bay.

12 - Project Management Features

In order to do this you do this
Change the column order	Click and drag column header left or right. You can do this with any of the five Project Bay tabs selected.
Hide/Show columns	Right click on any header, deselect/select from list.
Add an item to Source Media Bay	Drag and drop from Windows Explorer or REAPER's Media Explorer . You can drag an entire item or (if using Media Explorer) a time selection.
To preview an item	Select the item then press Space .
To add an item from Source Media or Media Items Bay to a project	<i>Either...</i> Drag and drop from Bay into the project arrange view window, <i>Or ...</i> Select track and position cursor in Arrange view. Right-click on item name in Bay and choose Insert into project from context menu. If not already active, its status will now be made Active.
To remove an item from within the project.	Select the item and use the Delete key, either from the arrange view window or within the Media Bay.
To remove an inactive item from Source Media Bay	Select item and press the Delete key, or right-click in item row in Retain column (to left of item name), then choose Remove from bay .
To remove all unused items from the Media bay	Right click on title bar, choose Remove all items that are not used in project from the context menu.
To remove the retain status of an active item	Select item in bay, right click in Retain column, choose Remove from bay if removed from project .
To remove all instances of an item from project	Right-click item in Retain column for the item, choose Remove from project .
To reassign retain status to an active item	Select item in Bay, right click in Retain column, choose Retain from menu.
To locate a Media Items Bay item or Source Media Bay item in the project	Click on the item in the list then on the Usage button. Click on any item in that list in order to go to and select that item.
	
To mute an item in project	Right-click on item, choose Mute from the context menu (to toggle).
To rename any media item	Select item in the Bay: click Rename button or use the context menu.
To add comment to an item	Double click in the comments column of the item row.
To filter the media item list	Type a text string in the Filter box (e.g. vox to see only media items with vox in their name) then click on the Refresh button.
To clear a filter	Click on Clear Filter button.
To replace a Source Media or Media Items item with another item	Select item name in Source Media or Media Items list. Right-click and choose Replace in project . Then select from flyout menu, e.g. All instances or any single instance: choose the replacement item. The media format (e.g. MP3, WAV) need not be the same for both items.
To save an item set list from the Bay (for possible use in other projects)	Select the items, then click on the Save button and choose one of the available options. You can Save selected items to a new project bay , or Save all items as a new project bay . For either of these, you will be prompted for a new .ReaBay file name. You also have the option to Save and merge selected items to an existing project bay file, in which case you will need to select the required file from the list.
To load a previously saved item set list.	Click on the Bay button, choose a .ReaBay file from the list. You may Load and merge it with the current one, or replace the current one.
To sort media items list.	Click on any column header to sort. Click again to reverse sort order.

The FX Bay and FX Parameter Bay

Many **FX Bay** management commands are the same as in the Media Bay – e.g., setting retain status on/off, applying and clearing filters, creating and using folders, and removing items from the media and FX bays are handled in exactly the same way. The example here shows three folders being used to organize the FX. This table emphasises those aspects more specific to the FX Bay itself.

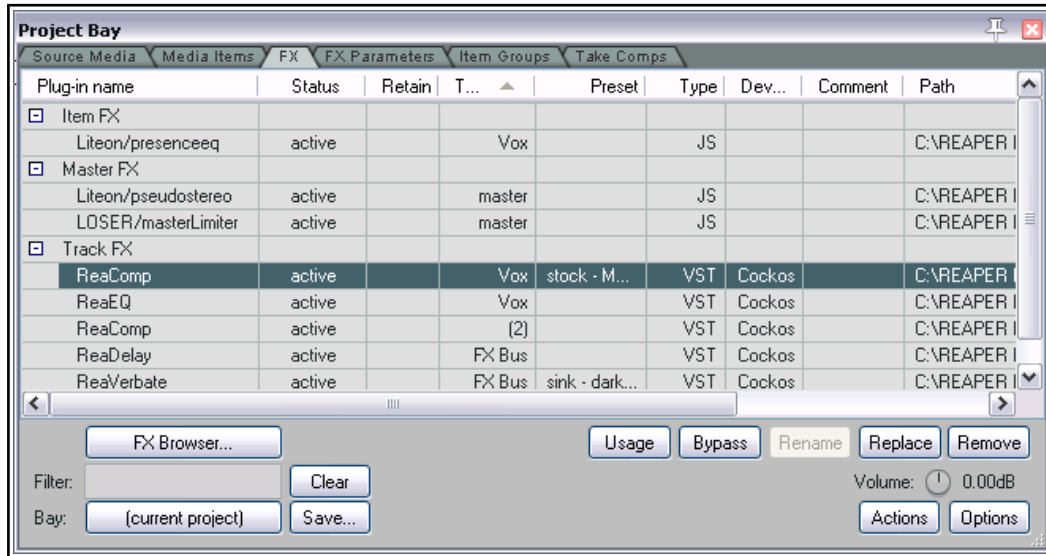

In order to do this you do this
Add FX from FX Bay to track or media item in project.	<i>Either...</i> Select track or media item in Arrange view, right-click on plug-in name in FX Bay, choose Insert into project <i>Or...</i> Drag and drop plug-in from FX Bay to track panel or media item.
Open FX browser window	Click on the FX Browser button.
Add FX to the FX Bay	Drag and drop from FX Browser.
Locate and open FX window for any FX instance	Right click over the track name or number in the Track column then click on the required instance. The Usage button can also be used for this. 
Toggle any FX to bypass or offline	Select the FX then choose Bypass or Offline from the right-click menu, <i>or</i> use the Bypass button (Shift-click for Offline).
Assign a preset to an FX (see note below table)	Right-click in the Preset column for the FX and select from the menu.
Manage any FX parameter	Right-click on FX name, choose FX parameters then FX parameters list , then select feature (e.g. Show in track controls or track envelope), then select parameter from list. More about this in Chapter 19.
Change FX instance preset	Right-click in the Preset column for the FX and select from the menu.
Replace one FX with another project bay FX	Right-click on FX name, choose Replace in project then select from the flyout menu of FX. You can replace all instances or a single instance.

Note: Some FX names may occur more than once in the list. In the example above, ReaComp appears twice. This is because one of these instances have been assigned a preset. This enables you to manage these separately. The preset **stock – Modern vocal** has been applied on one ReaComp on the Vox track.

Next to the **FX** tab in the Project Bay window there is a **FX Parameters** tab. This is used for managing various FX parameter features such as envelopes, learn mode and parameter modulation. This will be explained in Chapter 19, which deals with parameter modulation.

12.8 The Track Manager

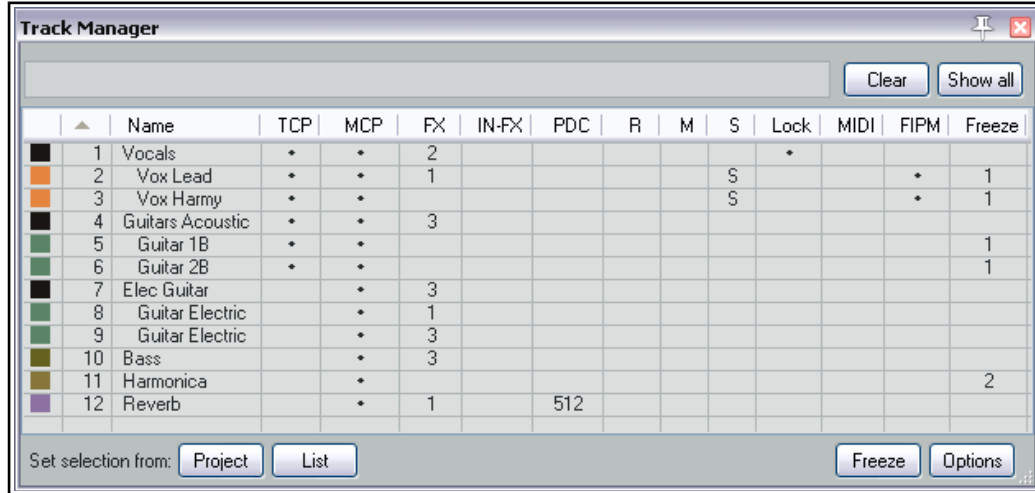

The **Track Manager (View, Track Manager)** gives you overview control of your tracks. It displays a grid similar to a spreadsheet or table. If the grid is empty, click on the **Show All** button (above right) to display a list of the project's tracks.

Click on the **Options** button or right-click on the title bar to display a menu which includes **Mirror track selection**. This allows any track selection made in either the Track Manager or the TCP to be automatically applied in the other. You can also ensure that when this is enabled, selecting a track in the Track Manager will **Scroll to selected track** in TCP and mixer.

If your project includes folders with child tracks, then that hierarchy is retained within the track manager's track list. The option to **Indent tracks in folders** can be disabled from the **Options** menu. The other **Options** button menu items are explained in their context in the table below. The table also summarises what you are able to do within the track manager window.

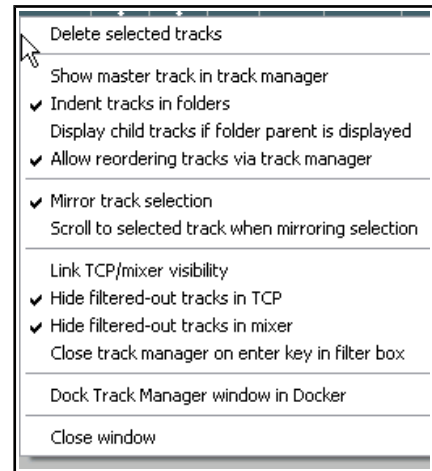

To do this you do this
Change column order	Click and drag column header left or right.
Hide/Show columns	Right click on any header, deselect/select from list.
Adjust column width	Click and drag left or right on boundaries between column headers,
Filter the track list by name	Type text in filter box: e.g. "vo" to list in Track Manager only those tracks whose name includes vo. Supports use of NOT and OR filters: e.g. "bass OR guit" will find all tracks with either bass or guit as part of their track name. Use the appropriate Options menu commands to also Hide filtered-out tracks in TCP and/or Hide filtered-out tracks in mixer . The Clear button removes the filter. There is also an option on this menu to Display child tracks if folder parent is displayed . If you enable the option Close track manager on enter key in filter box from the Options menu, then pressing Enter in the filter box will automatically close the Track Manager.

Up and Running: A REAPER User Guide v 5.24

To do this you do this
Change TCP track order in track manager	Drag and drop tracks up or down. This can be disabled by disabling Allow reordering tracks via track manager from the context menu.
Delete track	Select track row and press Delete . You will be prompted to confirm this.
Show/hide Master	Toggle Show master track in track manager in Options button menu.
Show/hide tracks in TCP/MCP	Click in track row in TCP/MCP columns. You can use the toggle option (on the Options button) to Link TCP/Mixer visibility to synchronize track display. Supports " Swipe " (see last row of table).
Scroll track into view	Double-click on track number in # column.
Set/change track color	Click on the small square colored icon in the column left of the track number.
Open/show track FX chain	The FX column shows the number of FX in each track's FX chain. Double-click on that cell to open the FX chain for that track.
Add FX to track or open an FX window	Right click over the track's FX cell and use context menu.
Open/show track Input FX chain	The IN-FX column shows the number of FX in each track's Input FX chain. Double-click on that cell to open the input FX chain for that track.
Monitor plug-in delay compensation	Any plug-in delay compensation used by a track's FX will be indicated (in ms) in the track's PDC cell. Clicking on this cell toggles track FX bypass.
Arm/unarm tracks for recording	Click in the R column for any track(s) to arm for recording. The letter R will be shown for armed tracks. Click again to unarm. Supports " Swipe " (below). Right click on any cell in this column to display record menu for that track.
Mute/unmute tracks	Click in the M column to toggle mute status. All the modifier keys used in the TCP can be used here – e.g. Ctrl Mute to unmute all. Right-click for TCP mute context menu – see Chapter 5. Also supports " Swipe " (see below).
Solo/unsolo tracks	Click in the S column to toggle solo status. All the modifier keys used in the TCP can be used here – e.g. Ctrl Alt Solo to solo exclusive. Right-click for TCP solo context menu – see Chapter 5. Also supports " Swipe " (see below).
Lock/unlock track controls	Click in the Lock column to toggle lock status. Locked tracks display a + sign. Supports " Swipe " (see last row of table).
Manage MIDI items	Double-click a track's MIDI cell to open track MIDI items in new MIDI Editor. If item is already open, double-click to close. Right-click in cell for menu of options: Open in new MIDI editor , Open in existing MIDI editor , Open in existing MIDI editor (clear editor first) or Remove from MIDI editor . The third of these options removes from the MIDI editor any tracks/items already open before opening this one.
Free Item Positioning on/off toggle	Click in the FIPM column to toggle on/off Free Item Positioning. FIPM on shows a + sign. Supports " Swipe " (see last row of table).
Freeze/unfreeze tracks	Select track(s) in Track Manager window, then choose whichever action you wish from the Freeze button menu. See also Chapter 6.
Sort Track Manager list	Click on any column header. Click again to reverse sort order.
Manage track groups	The track manager will respect grouped track parameters (Chapter 5). As with the grouping matrix, you can use Shift to temporarily over-ride these.
Swipe to toggle several adjacent tracks	For example, to arm several adjacent tracks for recording, or to mute several adjacent tracks, or to enable free item positioning on a series of adjacent tracks. Click and drag/sweep down the appropriate column.

In the example shown above this table, the **Vocal** and **Acoustic Guitar** tracks and folders are the only ones shown in the TCP. All tracks are shown in the Mixer. The **Vocals** folder settings have been locked. Both the **Vox Lead** and **Vox Harmy** tracks are soloed. They are also FIMP enabled. The **Reverb** track uses plug-in delay compensation of 512 ms. Tracks 2, 3, 5, 6, and 11 have all been frozen, track 11 twice.

Tip: You can use the **Screensets** window to save different sets of Track Manager settings as Track Views, any of which can be recalled in an instant. Screen sets are explained later in this chapter.

12.9 Track View Screen Sets

Screen Sets enable you to save several different views of your project, so that you can easily select and recall them when editing or arranging. There are two types of Screen Set – Track Views and Windows.

Track Views are created and saved on a per project basis – the screen set data is stored in the project's .RPP file and can be recalled only when you are working with that project file. Using track view screen sets can be especially useful when you are editing or in some other way working closely with media items.

Windows screen sets are global and are stored in the Application Data screensets.ini file. They can be recalled from, and applied to, any project file.

The procedure for creating track views is:

- Use the **View, Screensets/Layouts** command to show the Screen Sets window (the default keyboard shortcut is **Ctrl E**). The Screen Sets window may be docked (or undocked), and (if undocked) pinned to stay on top.
- Adjust your track layouts to suit.
- Select a number from the Track views page of the Screen Sets window.
- Click on **Save** and name the set.

You can create up to 10 track view screen sets per project file. To recall a view, double click on its name.

You can also assign keyboard shortcuts to individual screen sets. By default, **Shift F4** to **Shift F6** are used to save your first three track views, and **F4** to **F6** are assigned to load each of these first three track views.

If you want to modify these, or assign shortcuts to other track views, then you should click on the **Edit shortcuts** button in the Screensets window. This opens the **Action List Editor**. For instructions on how to use the Action List Editor, see Chapter 15.

Notice that there is also an option available to **Autosave when switching screensets**. If enabled, this ensures when switching from one screen set to another that any changes made to the layout of the first of these screen sets will be saved. The **Edit fields...** button can be used to "tweak" this, so that only certain aspects of your changes are automatically saved.

Example

1. Open the file **All Through The Night.RPP** and save it as **All Through The Night TRACK VIEWS.RPP**.

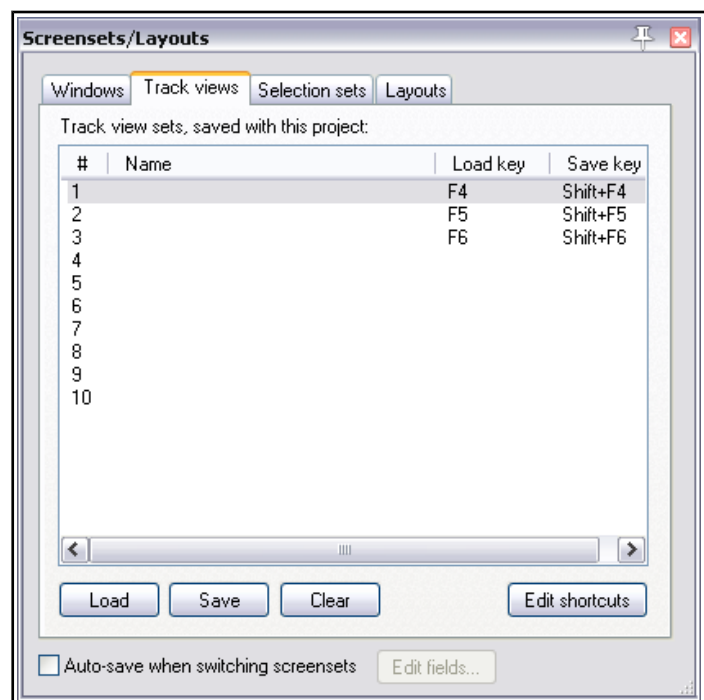

Up and Running: A REAPER User Guide v 5.24

- Adjust the track height of your **Vox** track as shown here (right).
- In the Track View page of the Screen Sets window, click on **1**, then **Save** to open the **Save Track View** window.
- Type: **Vox View** but do not yet press **Enter**.
- Take a look at the five options that are available. We'll examine these shortly. For this exercise, make sure that only **Track control panel status** is selected.
- Click on **Save**.
- Now adjust the track heights so that all tracks are minimized except the two guitar tracks. Make these two tracks high enough to show all track controls.
- In the Track views window, click on **2**.
- Click on **Save** to open the **Save Track View** window.
- Again make sure that only **Track control panel status** is enabled and type **Guitars View**. Press **Enter**.
- To switch between these track layouts, double-click on their names in the Screen Sets window.

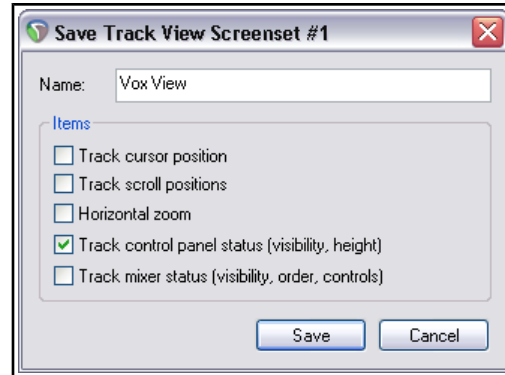

This simple example has introduced you to screen sets and how to use them. Because we selected only the option **Track control panel status** the project track layout was the only information saved with this screen set.

Notice the five options that you may choose to include in or exclude from a track view:

- Track Cursor Position
- Track Scroll Position
- Horizontal Zoom
- Track Control Panel Status
- Track Mixer Status

Let's then now work thru a further example which use options other than track height.

Example

- Horizontally zoom your project so that only the first 45 secs is displayed. Position the cursor at the 46 sec mark.
- In the track view page of the screensets window, click on **3** then on **Save**.
- Make sure that **ONLY Track cursor position** and **Horizontal zoom** are selected.
- Type a name for the screenset: **Verse 1**.
- Click on **Save**.

You can now at any time use track view screen set 3 to zoom to Verse 1 and position the play cursor there, and either of the other two screens sets to then zoom vertically to either the vocal or the guitar tracks. To remove any screen set that you do not wish to keep, simply select it and click on the **Clear** button.

Track Mixer Status

Notice that one of the options that you have when saving track view screensets is **Track Mixer** status. This option can be used to save any **Track Manager** settings regarding which tracks are and are not displayed in the Mixer at any time. Switching between different track views would then automatically select different selections of tracks to be shown in the Mixer.

Do not confuse this with the option **Mixer flags** in **Windows** screen sets, which allows you to select not which tracks but which mixer elements and options (FX inserts, sends, multiple rows, etc.) are applied.

Note: As you adjust the height and/or width of your track panel, the display area for track controls will become smaller or larger. Some control will disappear and reappear. An example is shown here.



12.10 Windows Screensets

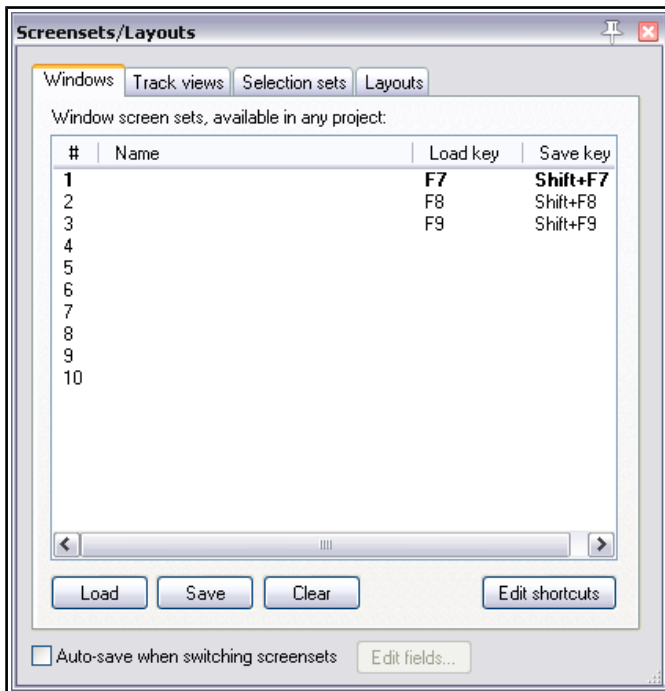

Unlike track view Screen Sets, Windows Screen Sets are not project specific, but can be applied to any project. They are stored in the Application Data folder in a file called screensets.ini.

After opening the Screensets/Layouts view (**Ctrl E**), the procedures for creating Windows screen sets are as follows:

- Decide which windows and views you want displayed, and arrange them on screen as you wish.
- In the Screen Sets window, select the **Windows** page, select a number, then click on **Save**. Type a name, then select as many of the six options as you require (see below). Click on **Save**.
- To recall and open any screen set, simply double-click on its name.
- To change a screen set, open it, make the changes, then save it.

You can also use keyboard shortcuts with Windows screensets. By default, **Shift F7** to

Shift F9 are assigned to saving Windows screen sets 1 to 3, and **F7** to **F9** are assigned to loading them. These assignments can be changed in the Actions List Editor (see Chapter 15).

The options that you may choose to include in or exclude from any screen set are:

- Main Window Position
- Tool Window Positions
- Docker Selected Tab
- Mixer Flags
- Layouts
- Last Focus

Some of these are self-explanatory. In addition, note that:

The **tool window position** option will cause the position of those windows which are defined by Windows as tool items (such as VST FX and the MIDI Editor) to be saved and recalled with the screen set. For any particular project, however, this will only be applied if that particular window exists in that project. This option is useful, for example, if you use a set of standard plug-ins in the Master and you want to easily be able to open and close all these FX windows when working with any project.

Enabling **docker selected tab** will ensure that whichever window in the docker is visible when the screen shot is saved will be visible when it is recalled.

The **mixer flags** option, if enabled, will save your various Mixer menu options (FX inserts, sends, folders, top level tracks, position of master, etc.) with the screen set. These options are discussed in detail in Chapter 11.

We encountered **layouts** in Chapter 11, in the context of the Mixer. You'll find more information about Layouts later in this chapter. Enabling this option will ensure that your layouts are saved with the screen set.

The **last focus** option can be selected to ensure that a particular view automatically is given focus whenever the Screen Set is loaded.

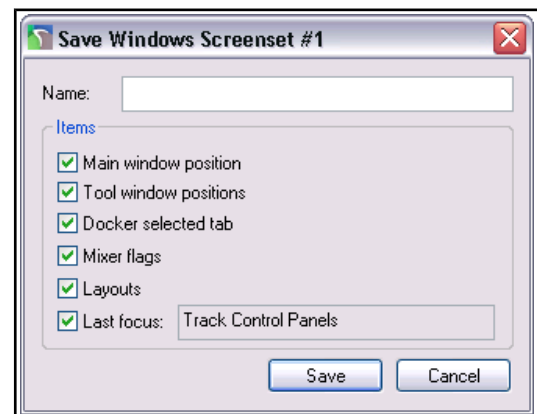

12.11 Auto Saving Screen Sets

You have the option to automatically save changes to your Track Views or Windows screen set layouts. To do this, simply ensure that the **Auto-save when switching screensets** option is selected (see right).

This can be used to ensure for example, that if you change the selected tab to be displayed in the docker before switching to a different Windows screen set, when you return to the first screen set, REAPER will have remembered which docker tab was last selected.

If using auto-save, consider using the **Edit fields...** button to decide which elements for which you want changes automatically saved (see right).

The available options are all items that were included in your options when you created your screen sets.

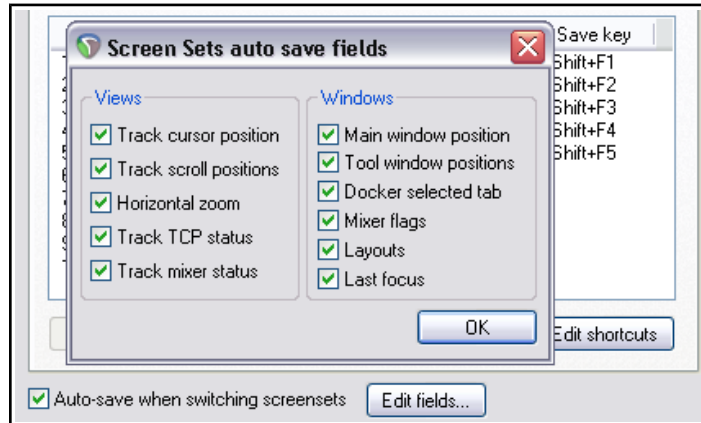

12.12 Item Selection Sets

By using item selection sets, you are able to create many different selections of items within a project file and select all of the items in any set simply by selecting that set name. The procedure is as follows:

- ◆ Use the command **View, Screensets/Layouts** to display the Screensets window.
- ◆ Select the **Selection sets** tab.
- ◆ Within your project, select all of the items to be included in the group. These can be on a single track or across any number of tracks.
- ◆ Select a set number, then click on **Save**.
- ◆ Give the group a name and press **Enter**.

At any time you can now recall that group by double-clicking on its name, or by selecting the name and clicking on **Load**.

In the example shown here, two selection sets have been created, one for Vox Verses and one for Vox Choruses. Simply by double-clicking on the required set name, we can select all of the items in either set.

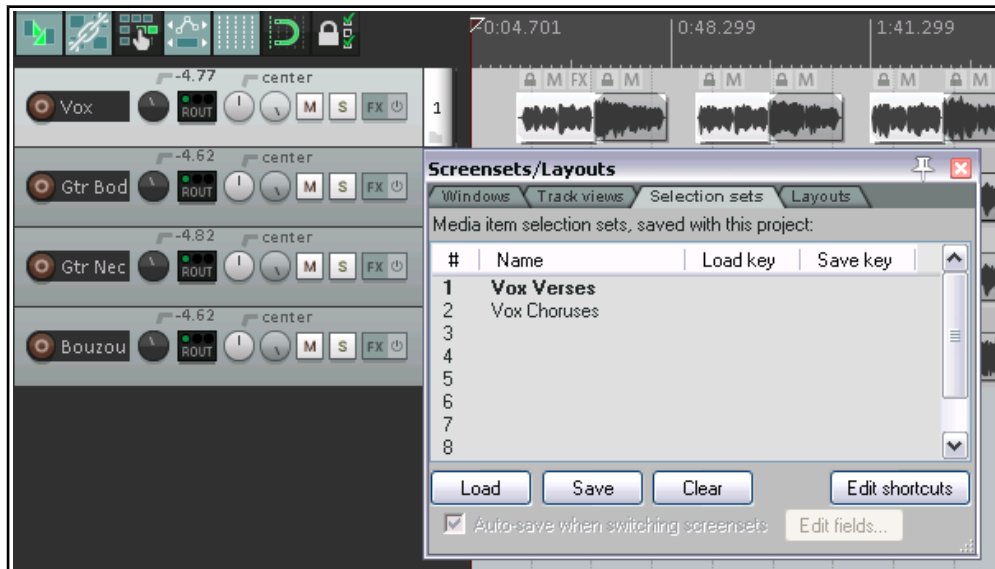

12.13 Track, Mixer, Transport and Envelope Layouts

Layouts in general, and mixer layouts in particular, were discussed in Chapter 11. Layouts are created, stored and retrieved with individual themes. From the **Layouts** tab of the Screensets/Layouts window you can select any theme from the drop down theme list.

Layouts are designed and created for use with individual themes. Therefore, the choice of layouts available to you will be largely dependant on which theme you are using. Themes can be downloaded from stash.reaper.fm.

Layouts associated with your chosen theme will be available to you from the various drop-down lists in this window, such as track panel layouts and mixer panel layouts. For earlier themes that do not include any layouts, a number of standard layouts are available.

Shown right is an example, in this case double-clicking to display the Mixer Panel drop down list and to select a mixer layout.

This is an example only – the exact range of choices available to you may not be exactly the same as shown here. When one of these drop down lists is displayed you can hover your mouse over any item to see how it looks, in this example in the mixer.

Here is a summary list of the main layout elements available:

Global Layout	Selects theme defaults for all layout elements.
Transport	Selects a layout for the Transport bar.
Envelope Panel	Selects a layout for track envelope panels. See Chapter 18.
Master Mixer Panel	Selects a layout for the Master in the Mixer panel.
Mixer Panel	Selects a layout for all tracks and folders in the Mixer panel.
Master Track Panel	Selects a layout for the Master in the Track control panel.
Track Panel	Selects a layout for all tracks and folders in the Track Control panel.
Selected track panel	Selects a layout for selected tracks in the Track Control panel.
Selected track mixer panel	Selects a layout for selected tracks in the Mixer panel.

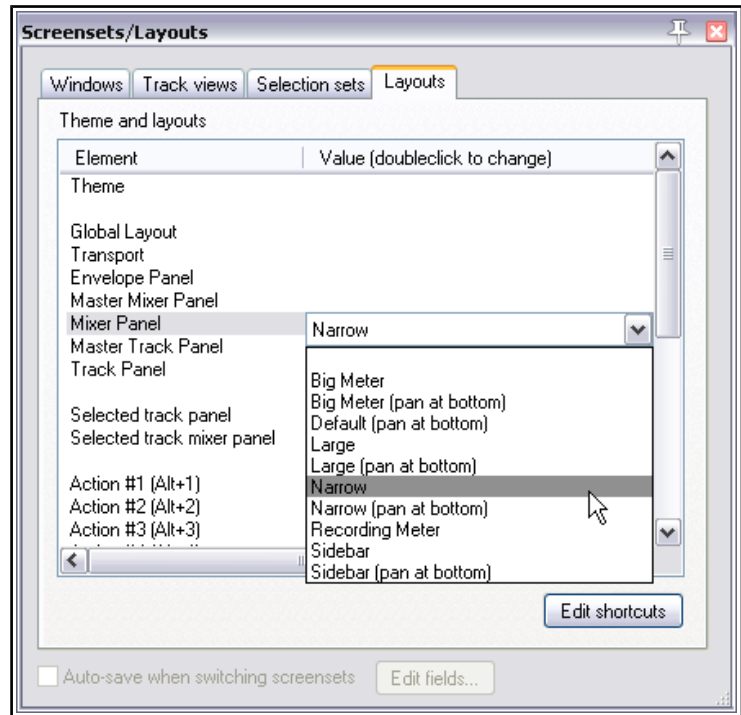

Shown here is an example of one rather different track panel layout that you might choose – Standard Media. Amongst other things, it uses horizontal faders (rather than rotaries) for volume control.

You do not need to open the Layouts window to select layouts for a project. You can also use the **Options, Layouts** command from the main menu or the **Set track layout** command from the TCP or MCP context menu.

Up and Running: A REAPER User Guide v 5.24

Assigning Actions to Layouts

Within the Layouts screen you can assign up to 20 actions to quickly recall any layout. These can be assigned to shortcut keys and/or to custom toolbars.

In the example shown here, Action #1 has been assigned to select a Track Panel layout called Tracking and Action #2 is being assigned to select a different Track Panel called Vertical (vertical meters). You could then click on the **Edit shortcuts** button and assign shortcuts to the two actions **Layout: apply custom layout #01** and **Layout: apply custom layout #02**. You could also use the **Customize toolbar** editor to create icons for these actions on one of your toolbars. See Chapter 15 for information on both how to assign keyboard shortcuts and how to create custom toolbars.

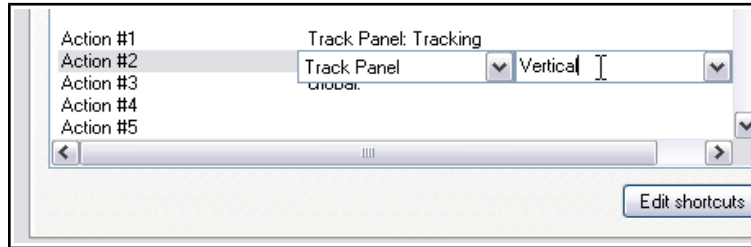

Default Theme Layouts

The drop down lists in the various Layouts categories include many options that you can explore. These include **Track Panel** specialist layouts for recording and tracking, and layouts with vertical meters. **Mixer Panel** layouts include narrow channel strips and wider strips with a sidebar to display FX chains, sends, etc. (see example right).



12.14 Further FX Parameter Management

In Chapters 2 and 5 we looked at some uses for the **Param** button in REAPER's FX plug-in windows. In chapters 16 and 17 you'll see how this can also be used to create automation envelopes and for parameter modulation. Meanwhile, here are some other ways in which you can use them.

If you touch any FX control (such as a fader) with your mouse and then click on the **Param** button you will see a menu similar to that shown here. In summary, these options are:

Show in track controls. Adds a rotary fader to TCP and (optionally) MCP for adjusting that parameter's value. See Chapter 11 and below.

Show track envelope. Adds an envelope for automating that parameter – see Chapter 18.

Parameter modulation. Enables parameter modulation for this item – see Chapter 19.

Learn. Allows you to assign this parameter to an external control device, such as a fader or button on a control surface – see The Learn Option below.

Alias parameter. Allows you to assign your own name to this one instance of this parameter. This name will be used, for example, on any track control or envelope that you create for this parameter.

FX parameter list. This causes a flyout menu of a list of all parameter controls for this FX to be shown. Using this menu is another method of assigning (or unassigning) any of these options to any parameter, rather than touching it with your mouse – see above right.

Most of these options are available only with FX in a track's FX chain (including the Master). However, **Learn** is also available with record input FX and monitoring FX. **Learn** and **Show track envelope** are both available with per take FX.

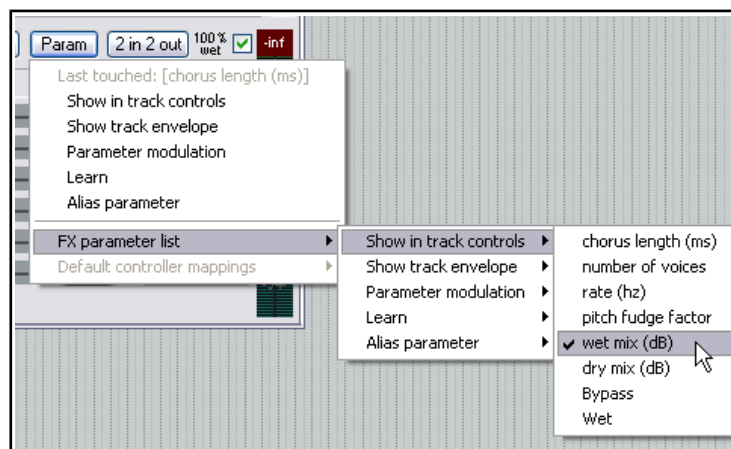
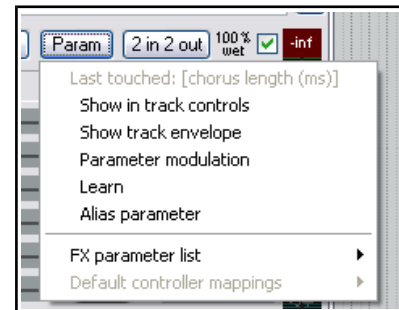

The Learn Option

Let's take a closer look at the **Learn** option.

When you touch the control in the FX window with your mouse and then click on **Learn** the Learn window is displayed (see below).

Twiddling the control (such as fader or rotary) on your control surface device will cause information to be displayed in the **Command** window about the channel and CC assignment for this control. This information is picked up from the control surface.

Choice of CC mode (absolute or relative) will depend on the parameter being assigned and your own control device. In many cases, absolute mode with soft takeover will be appropriate, but you may need to experiment.

The option to **Enable only when effect configuration is focused** is especially powerful – it means that this control surface assignment will only be used when that particular plug-in has focus. This enables you to assign the same control surface fader to any number of different functions with different plug-ins. For example, the same fader used to control EQ gain in one plug-in could also be used to control the threshold setting on a compressor.

When one or more parameters in a plug-in has been assigned to a control surface, you will see an extra command on the **Param** menu – **Default controller mappings**.

This leads to a flyout menu (right). You can use this menu to save these settings as the default for this plug-in, so that these controls will be automatically made available whenever that plug-in is loaded into other tracks. Other options on this menu (where a default has previously been saved) are to **Clear default** or **Use default**.

Show in track controls

When track controls are shown in the TCP and MCP, they are not only controls for individual parameters. They also serve as a gateway to managing your console. To display these in the Mixer, you must enable the option **Show FX parameters when size permits** from the Mixer menu.

Right click over any of the controls in the TCP or MCP for menu (see right). This menu includes: **Remove from list**. This removes the control from the TCP and MCP.

Learn, Modulate, Envelope and **Alias**. These four options are the same as on the **Param** button menu in the FX window. For example, from here you can add control surface support to any of your custom track controls by choosing **Learn**.

Plug-in Menu (shown in the example below are ReaEQ and ReaDelay). This lists the plug-ins in the track's FX chain, together with a flyout menu of all their parameters. You can use this menu to add controls for any of these parameters: the menu includes the option **All parameters**. In the MCP, when the option **Show FX parameters when size permits** is enabled, you can right-click in this area for any track to add controls to that track. An example is shown right. The actual menu that is displayed will, of course, depend on which FX are included in the track's FX chain.

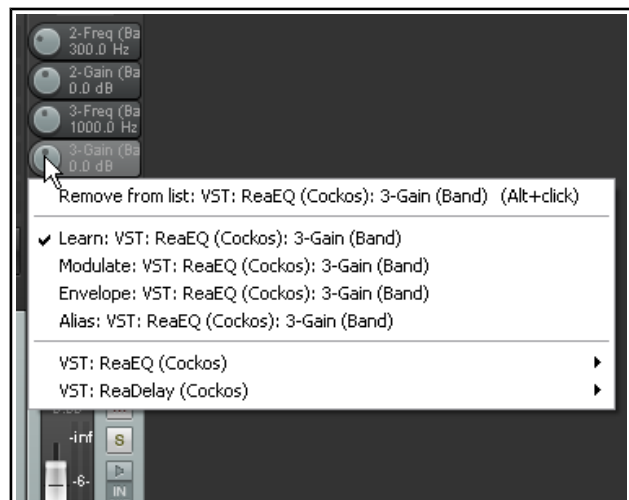
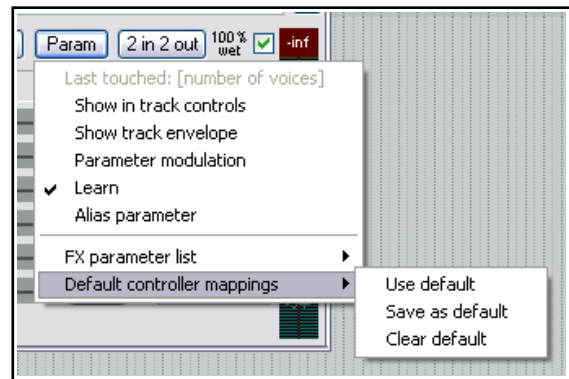
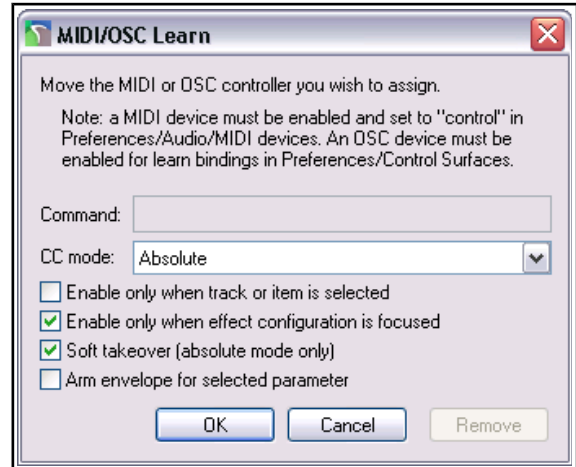

Track Templates

Back in Chapter 3 when you were introduced to recording, we mentioned track templates and how useful they can be. Now that you have discovered a lot more about REAPER, it's worth revisiting this topic. Track templates can be your best friend when you are setting up your projects.

A track template can be made up of any track or any selection of tracks. For example, you might have a folder called Drums. This might contain a series of child tracks – Kick, Snare, Toms, Hi hat, etc. – all of which have their own track FX with their own settings, and with volume and pan faders set at their own levels. You could save the entire folder (parent) with its child tracks and all their settings into a single track template called Drum Kit.

Items that get included in track templates include track name, track control settings, track properties (color, icon, etc.), track FX (together with their parameter settings), track controls, FX alias names and FX parameter alias names, parameter modulation, FX parameters, sends and receives, and more.

To save a track (or selection of tracks) as a track template, choose **Track, Save tracks as track template**

from the main menu. To insert tracks from a track template into a project, choose **Insert track from template** from the same menu.

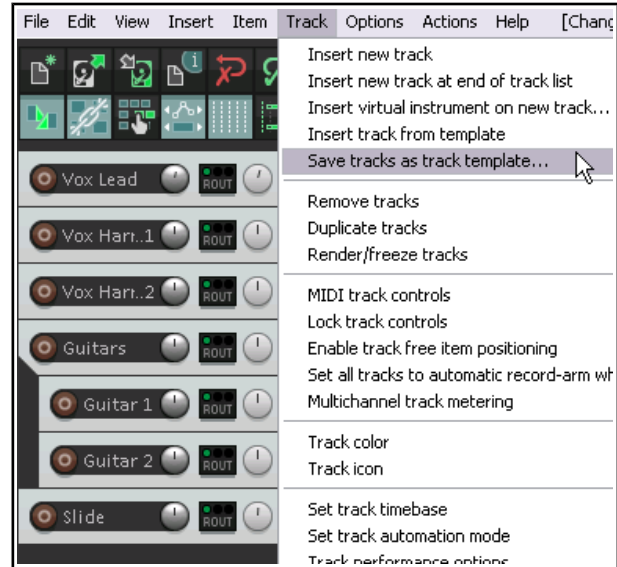

12.15 Track Control Panel and Menu Bar Help

A selection of useful information can be displayed below the control panel and at the end of the main menu bar. Right click just below the track control panel and select from these options:

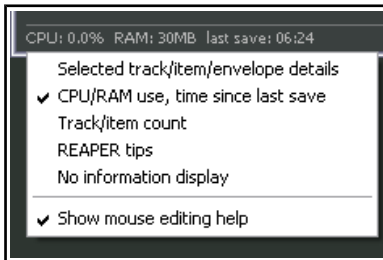

Selected track/item/envelope details
CPU/RAM usage, Time since last save
Track/item count
REAPER tips
No information display
Show mouse editing help

The first five of these options are mutually exclusive: that is you can select only one of them. In the case

of the menu bar (right hand end), you can select as many or as few of the following options:

- Show free disk space**
- Show recording path**
- Show recording volume name**
- Show recording format**
- Show audio device information**

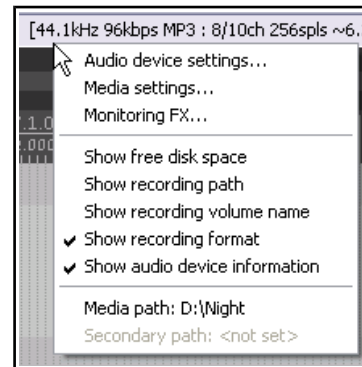

This menu also gives you access to the **Audio Device** page of your preferences, the **Media Settings** page of your project settings, and the **Monitoring FX** window.

12.16 Using Multiple Dockers

In Chapter 2 you were introduced to working with REAPER's docker as an aid to navigating your way thru REAPER's various views and windows. In fact you are not restricted to just one docker: you can create up to 16 dockers if you wish. In the example shown here, we have two dockers attached to the bottom of the main window and a floating docker. The first docker (bottom left) contains tabs for displaying the Routing matrix, the Mixer, and the Media Explorer. The second is used to display at any time the Screensets window, the Track Manager or the Undo History. The floating window is a third docker, and this contains tabs for displaying the FX chains for four of the tracks in the current project. This is, of course, only an example.

12 - Project Management Features

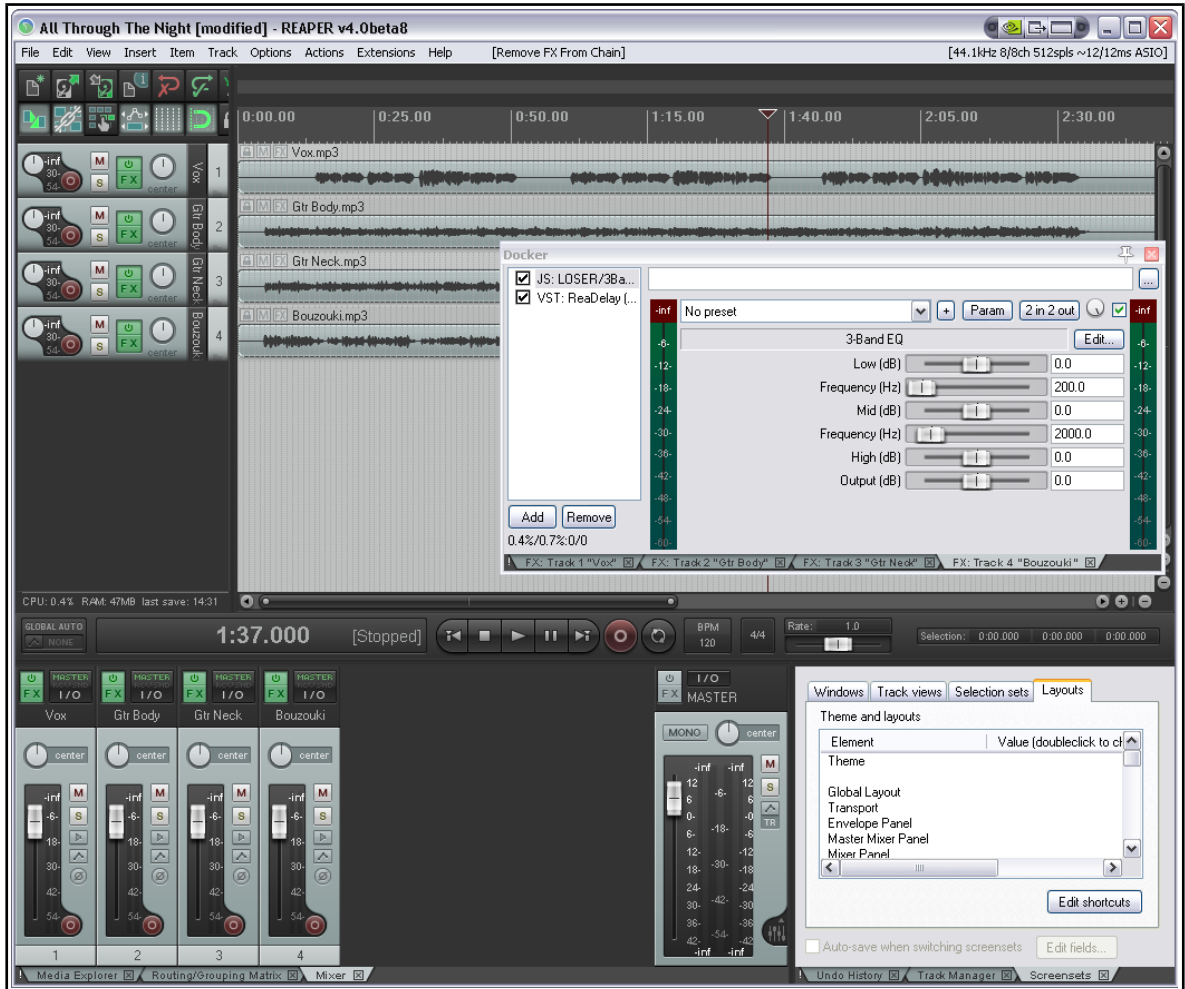

These instructions assume that you are already familiar with the basic techniques for docking and undocking windows, and so on, as explained in Chapter 2. You can attach any docker to the main window in any of the four positions. You can also choose the same position for more than one docker (for example, you might wish to attach two dockers to the right).

To do this ...	You need to do this ...
<p>Attach a docker to the main window</p>	<p>Click on the ! to display the menu, then choose Attach docker to main window, then select a position (bottom, left, top or right). More than one docker can be attached to any of these positions. Click and drag on the boundary between two dockers docked in the same position to adjust the position of the boundary between them (and therefore the relative size of the two dockers). Use this menu also to change the position of a docker, e.g. from top to left.</p> <div data-bbox="1068 1413 1458 1724" data-label="List-Group" style="border: 1px solid black; padding: 5px;"> <ul style="list-style-type: none"> <input checked="" type="checkbox"/> Attach Docker to main window <input checked="" type="checkbox"/> Attached docker position: bottom Attached docker position: left Attached docker position: top Attached docker position: right <input checked="" type="checkbox"/> Compact docker when small and single tab <input checked="" type="checkbox"/> Show tab close buttons Set opacity Hide dock Close all windows in dock </div>
<p>Dock a window</p>	<p>Right-click on the window's title bar and choose the command Dock ... in Docker.</p>
<p>Create a new docker</p>	<p>Drag and drop any tab from an existing docker into the arrange view area.</p>

Up and Running: A REAPER User Guide v 5.24

To do this ...	You need to do this ...
Move a window from one docker to another	Drag and drop the tab from its present docker to its new one.
Reorder tabs in any docker	Drag and drop tabs left or right.
Close a docked tab	Alt Click on tab, or click on tab x button.

12.17 Saving New Project Versions

REAPER's action list includes an action **File: Save new version of project (automatically increment project name)** which by default is assigned to the keyboard shortcut **Ctrl Alt Shift S**. This causes a new .RPP file to be created when you save a project. Thus, if, for example, you have a file open called WinterBlues.RPP then running this action would cause this project in its current state to be saved as WinterBlues_1.RPP. Running the action again would save it as WinterBlues_2.RPP, and so on.

12.18 Multiple Project Backup Versions

The **Project** page of REAPER's Preferences includes an option when saving to create multiple rpp-bak backup files. To do this, enable the option **Keep multiple versions**, with or without (as you wish) their own undo histories. If enabled, using **File, Save project as...** to save a project (over writing the previous file) will cause a new time and date stamped backup version to be created.

Opening the .RPP file will always open the most recently saved version. However, opening the **RPP-BAK** file will cause a **Choose version from backup file** dialog to be displayed. Here you can select which version you would like to load. With multiple project tabs you are able to have multiple versions open at the same time.

12.19 Associating Rendered WAV Files with Source Project Files

When using the **File, Render** command to render a project (or part of a project) to .WAV file(s), there is an option to **Include project file name in BWF data**. Rendering is discussed in detail in Chapter 21. If this option is enabled, the RPP project name will be embedded in the rendered file(s). This ensures that this RPP file will remain associated with the rendered WAV file(s).

If any file rendered with this option enabled is subsequently inserted into another project, then the command **Open associated project in tab: xxx.RPP** (where "xxx" represents the associated project file name) will appear under **Open items in editor** on the media item context menu.



This can be used to create a new project tab into which it will open the associated RPP file.

12.20 Projects and Subprojects

A very powerful feature of REAPER is the ability to build a master project that uses any number of subprojects, rather than having to store all your individual tracks, folders and media items within a single project file. As you are about to see, this has many potential applications but is likely to be especially useful for those projects which require a very large number of tracks or for sound design projects where you might wish to use subprojects to build a single overall audio item. The more the subprojects contain multiple media items which need intricate editing, or make use of features such as automation, parameter modulation and FX, the greater are the potential benefits (in terms of project management) that can be gained from using subprojects. A more advanced application might be for a single subproject (or proxy) to be used in multiple projects (for example, advertisements), so that when it is updated all of the "master" projects are automatically updated.

Before you consider working with subprojects, however, you should first develop a solid knowledge and understanding of REAPER's essential project building features, such as (but not confined to) audio and MIDI recording, the media explorer, editing media items, track and item FX and automation, and so on.

In principle, subprojects are not too difficult to understand. Shortly we will work thru an example. In overview, the *basic* steps involved in using it are as follows:

12 - Project Management Features

1. Create a new project file in the normal way (**Ctrl N**), and save it. In doing this, it is advisable to select the option to create a subdirectory for the project. Consider also whether you wish to use one of the options to copy or move all media into the project directory.
2. Create (either by recording or importing, or some combination of both) one or more tracks for this project, such as some foundation tracks or a guide track. You do not have to do this before adding any subprojects, but it can often make sense to do so.
3. Create a track to "hold" your subproject. The reason for this should become clear shortly. Name this track: e.g., if it is for drums, call it Drums, or for strings, call it Strings, or for foley or sound effects call it Foley or SFX, and so on.
4. Select this track and choose the command **Insert, New subproject**. If you wish, you can set the initial length of the subproject by defining a time selection before doing this. When prompted, accept the default name or make up a name (e.g. DrumsSub, StringsSub, etc.) and click on **Save**.
5. A short media item will be inserted at the play cursor position. This is (or represents) the subproject.
6. Double-click on this item to open the sub-project in a new tab. Two markers are automatically created, (=START and =END) at the start and end of the subproject. They define the rendered portion of the subproject, and can be moved or deleted at any time.
7. Build your subproject by recording or importing media as required. Various options that control playback behavior when working with multiple projects open are available on the project tab context menu. We'll get round to explaining these shortly.
8. When finished, press **Ctrl S** to save the subproject. The media items will be rendered to a single file which will appear as a single media item on its own track in the main project.
9. Display the main project (select its project tab). You may need to extend the length of the media item on the sub project track to display its contents. You may now close the subproject file if you wish. It can be re-opened by double-clicking on the media item in the main project file. With large projects (e.g. with many sample based instruments) that are slow to load it can be simpler just to keep them open, although doing so will use more RAM.
10. When you play the main project file, its output will now include the rendered contents of your subproject.

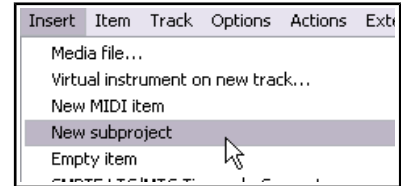

Example

Let's now look at an example of how this might be done in practice. To make it easier to understand, this example will be kept to a simple project. After reading thru this, you might be able to then think of a further example that you can try out for yourself using your own projects.

1. Here we have created a new project file, and saved it into its own subdirectory, calling it **WaitingMain.RPP**, We have recorded a guide track and added a second track, called Drums.

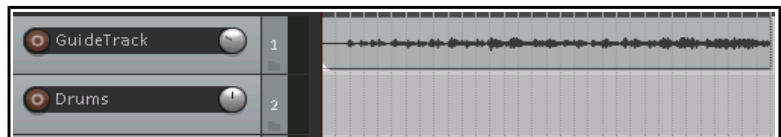

2. After selecting the Drums track we used the command **Insert, New subproject** to insert a subproject which we named and saved as **DrumsSub.RPP**. Notice both the short media item that is automatically added to the track and the new project tab above the toolbar.



3. We select the DrumsSub subproject either by clicking on its project tab or by double-clicking on the media item. We right click on this file's project tab and enable the options **Synchronize any parent projects on playback, Run background projects, Run stopped background projects, Play stopped background projects**

Up and Running: A REAPER User Guide v 5.24

with active project and **Synchronize play start times w/play background projects**.. We'll get to the two markers shortly.

4. We build our drum tracks in the normal way. For the sake of simplicity, in this example we have just added two tracks, but of course we could have as many as we require. Whenever we play these back, the guide track in the master project will also be heard. Track volume and pan settings are adjusted as required, FX and envelopes are added, and so on. When finished, we move the =END marker to the end of the tracks.

5. We now save this file. Notice that audio output is rendered as the file is saved. We return to the main project. At first sight, nothing seems to have changed:

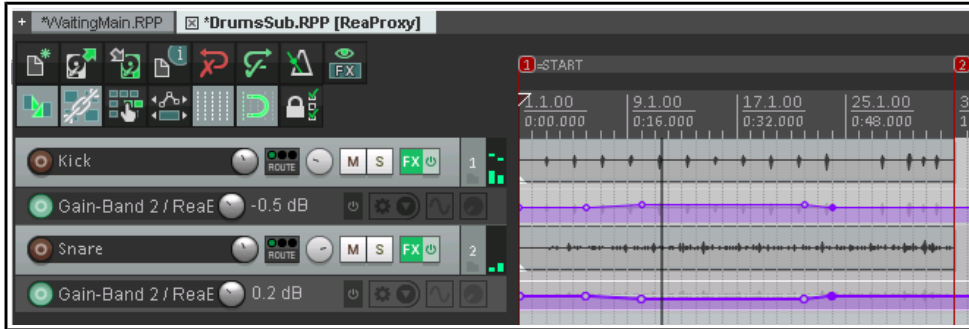

6. However, when we extend the media item to the right, we can see the rendered drums:

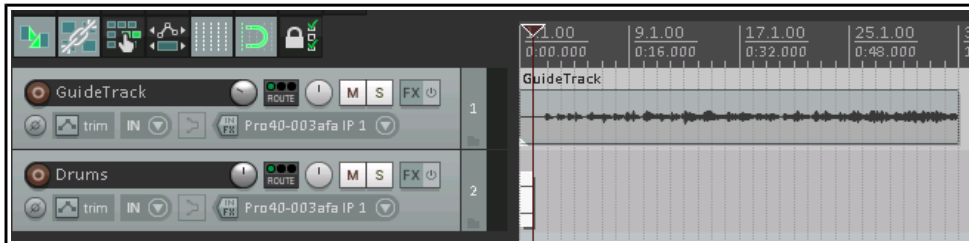

7. If we close the DrumsSub project and play the main project file, the rendered drums can clearly be heard along with the guide track.

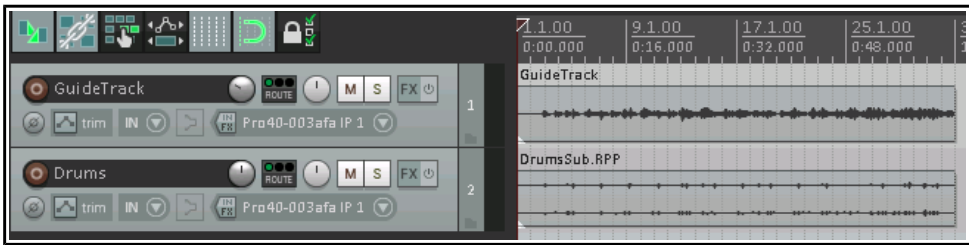

8. Any later changes that we make to the DrumsSub project will be included in the audio file that is rendered when the subproject is saved. Thus, when the main project is next opened, the audio item on the Drums track will include these updates.

9. We can now add further subprojects, in this example one each for the vocals and the rhythm section. The guide track is no longer required: it can be muted and hidden. We can also make further edits, add FX, etc. to the rendered subproject tracks:

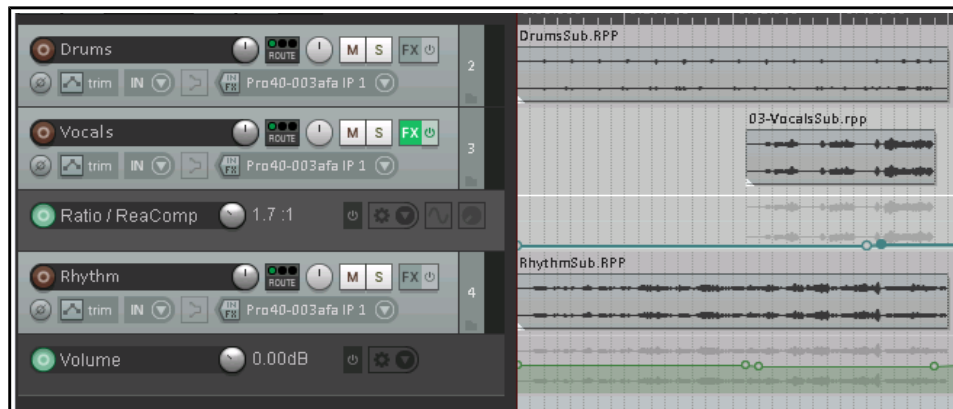

This example has been kept simple for learning purposes. In practise, subprojects are most useful when working with complex and intense applications such as movie scores, radio programs, large orchestral arrangements, game/video sound design and electronic music production. Another potential application is in finalising an album, with each song being inserted as a separate subproject within a master project.

Working with subprojects ... some handy tips and hints

It's easy to stumble and make (sometimes elementary) mistakes when trying out something new. These comments are not comprehensive but they are here to help you.

Creating a subproject file

- ◆ It's not the end of the world if you forget to position the edit cursor in the master project accurately before creating a subproject. You can move the media item within the master project file later.
- ◆ You can specify the position and length of a subproject by defining a time selection before you create it.
- ◆ It usually pays to ensure that the master project is set up within a new folder, and the subprojects are all stored in that same folder.
- ◆ Don't use the name of an existing file in the same folder as a subproject file name. If you do, you will overwrite that file with a new empty one.
- ◆ Individual media items from an existing project file can be imported into a subproject file in the usual way (e.g. using REAPER's **Insert, Media item** command, or via the media explorer).
- ◆ An existing .RPP project file can be imported into a master project as a new subproject item.
Either drag and drop the .RPP file from media explorer into an empty track in the master file, and when prompted choose **Insert project as media item**,
or select the empty track and use the **Insert, Media file...** command.
- ◆ An existing media item (or item selection) in a master project file can be extracted from the master file and moved into a new subproject file. Right-click on the selected item(s) and choose **Move items to new subproject**. Items within the selection on the same track will be moved to a single subproject file. Items on different tracks will be each be moved into a separate subproject file. The subproject file is fully editable: its contents will appear in the master project file as a single item, which will be updated each time the subproject file is saved.
- ◆ An entire track or selection of existing tracks in a master project file can be converted into a subproject by following these steps:
 1. In the TCP, select the track or a number of tracks. If these are enclosed in a folder, include the folder in your selection.
 2. From the main menu, choose **Track, Move tracks to new subproject**.
The tracks (including any folders) will be moved and saved to a new subproject file: their output will appear in the master file as a rendered single item on a single track. Note, however, that any sends/receives between the selected tracks and any other tracks in the master file will be removed.

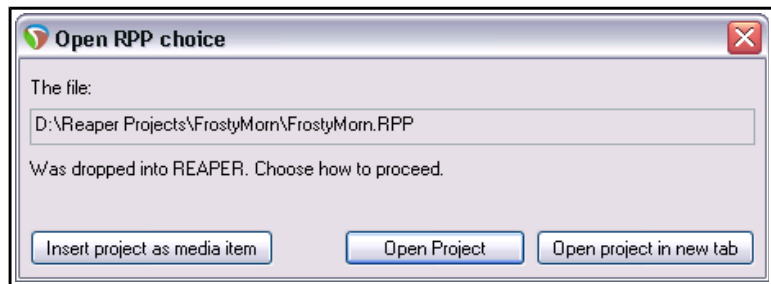

Working with subproject files

- ◆ If your master/subproject arrangements become very complicated, and you wish to be able to save without having to wait for rendering to complete, click on one of the project tabs and enable the option **Defer rendering of subprojects (render on tab switch rather than on save)**.
- ◆ A new subproject file will take some project settings (e.g. BPM, time sig) from the master project file. However, changes to master project settings will not be automatically applied to subprojects.
- ◆ You do not need to have the master file (or any other file) open when you are working on a subproject file. The file will be automatically re-rendered when you save your changes, and it is this re-rendered version that will be displayed when you next open the master file. However, often you will want to have the master project file open, to give your subproject file(s) relevant context.

- ◆ The =START and =END markers can be used to ensure that only a portion of the material in a subproject file is rendered and returned to the master file when the project is saved (shown here).

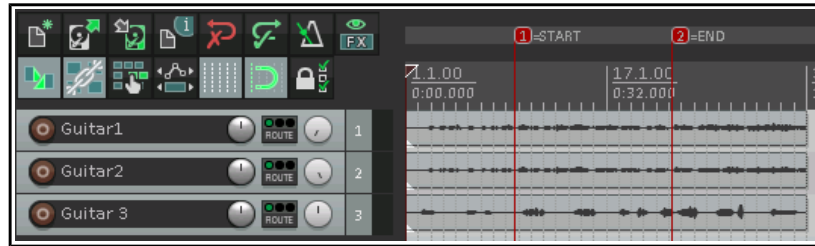

- ◆ If you delete these two markers, the entire project from the start (zero on timeline) to the end of the last item will be rendered when the file is saved. This could lead to the loss of reverb tails if the reverb is intended to play beyond the end of the last item.
- ◆ When you play back a subproject file with **Run background projects** and **Synchronize any parent projects on playback** enabled, the item takes in the master file that correspond with that subproject file will be automatically muted, and remains so as long as that subproject remains the active project.. This prevents the same material from being played twice.
- ◆ If when working on a subproject file you wish to hear only the contents of that file on playback, you should disable the project tab option **Synchronize any parent projects on playback**.
- ◆ Be aware that if a subproject has been edited within the parent project (e.g. with FX, playrate changes, etc.) the **Synchronize any parent projects on playback** option may not produce the same results as playback of the parent project would provide.
- ◆ You have already learnt that when a subproject file is saved its contents are rendered to audio. This process uses that file's project render realtime/online settings. Thus, if you wish you can use different render settings for different subproject files.
- ◆ A subproject file can be auditioned in media explorer. Navigate to the correct folder, and select the .RPP project in the usual way. The audio render will be played. This enables you to play it back in media explorer without having to open it. Within media explorer, the **Options** menu includes **Auto-render proxy (subproject) to preview REAPER.RPP projects**. If enabled, this ensures that when you select an .RPP subproject view for preview, if it needs rendering it will automatically be rendered.
- ◆ Within the main project file, you can create a new take of any subproject item. Just right-click on the media item and from the context menu choose **Open items in editor**, then **Open item copies in subproject tab**. You will now have two subproject files for this track. These two files can be edited independently of each other and will be displayed in the master project as two separate takes. They can be manipulated and edited in exactly the same way as any other takes.
- ◆ Your subproject files, like any other project files, can include markers and regions, as you wish. On saving, any regions will be identifiable within that subproject's rendered media item in the main project file.



Summary of master and subproject project tab options

Parent projects:

If you enable the option **Run background projects** then you can fine tune how the background projects should behave by enabling or disabling any or all of the options **Run stopped background projects**, **Play stopped background projects with active project** and **Synchronize play start times w/play background projects**.

Subprojects:

If you enable the option **Run background projects** then you can fine tune how the background projects should behave by enabling or disabling any or all of the options **Synchronize any parent projects on playback**, **Run stopped background projects**, **Play stopped background projects with active project** and **Synchronize play start times w/play background projects**.

For both parent and subproject s, the option **Defer rendering of subprojects (render on tab switch rather than save)** is available, as is **Leave subproject open in tab after automatic open and render**.

13 Manipulating and Editing MIDI Items

13.1 Introduction

REAPER has a number of techniques for manipulating and editing your MIDI items. In brief these are:

- Many of the commands on the arrange view right-click media item context menu can be used with MIDI items as much as they can with audio items – for example you can create and manipulate multiple takes, add MIDI FX to a take's FX chain, cut, copy and move items, and so on.
- In addition, there are commands on the arrange view right-click item context menu that are specific to MIDI items and only MIDI items. We'll get to these soon enough.
- You can open any MIDI items or selection of MIDI items in REAPER's MIDI Editor for detailed editing. You can choose either to open a single item, several items together in the same single MIDI Editor window, or to use a separate window for each item.
- For quick MIDI editing, you can edit the track in-line. This makes the item's content available for editing without needing to open a separate MIDI editing window. This is covered near the end of this chapter.

Before looking at editing, however, we'll resolve a couple of other issues of importance to MIDI users.

13.2 Monitoring an External Synthesizer

An external synthesizer can be monitored using MIDI or audio input. Just do this:

Activity	Procedures
Monitor using MIDI Input	Insert a track and name it. Arm it for recording and turn record monitoring on Set record mode to Disable (input monitoring only) Select Input: MIDI, then the device, then the channel(s) Open the track's routing (I/O) window, select your MIDI Hardware Output.
Monitor using Audio Input	Insert a track and name it. Arm it for recording turn record monitoring on Set record mode to Disable (input monitoring only) Select the necessary mono or stereo audio input from the synth's audio interface.

13.3 Using Track Controls with MIDI

As mentioned in Chapter 5, REAPER's track volume and pan controls by default control a track's audio signals. If you wish to use these for MIDI instead, you can do so. Right click on the track number in the TCP or MCP and choose **MIDI Track Controls** then select one of the **Link track volume/pan to MIDI** options from the menu. You can choose all channels or any individual channel.

You can also use the plug-in **ReaControl MIDI** with any track.

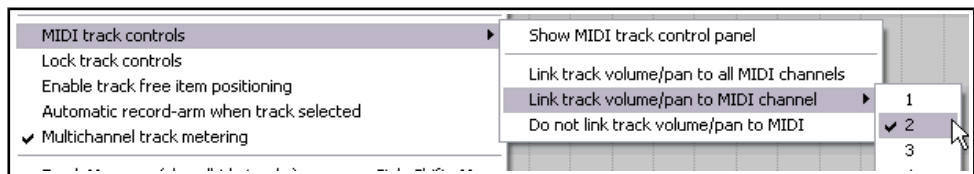

This is explained in detail in Chapter 16.

13.4 Controlling MIDI Data Sends

REAPER's sends and receives can be used with audio items, MIDI items, or both. You have already been introduced to this topic (Chapter 5), and it is covered in more depth in Chapter 17. Meanwhile, note that the button indicated on the right can be used to ensure that a send's fader controls are used to control the MIDI data.



With this button enabled, CC messages CC07 for Volume (127, max) and CC10 Pan (64, center) are sent on the selected channels (by default, all channels). If there are any MIDI items (even empty ones) on the sending track, they are sent when transport starts or stops, or play position changes. However be aware that not all synths and plug-ins recognize this feature.

13.5 Configuring and Accessing the MIDI Editor

Note: Many of the illustrations used in this chapter use the REAPER 4 default color theme. The instructions and actions are nevertheless accurate for REAPER 5.

The MIDI Editor needs to be opened from an existing item. If you wish to open it with a “clean sheet” then you must first create a new empty MIDI item. To do this, select the required track and (optionally) make your time selection to define the length of the item. Then choose **Insert, New MIDI Item** from the main menu.

By default, MIDI items created in this way are loop enabled. You can change this for an individual items within its Media Item Properties dialog box, or globally on the **Project, Media Item Defaults** page of your Preferences settings.

The MIDI Editor can be opened by any of these methods, using a single MIDI item (either recorded or empty):

- ◆ Unless you have changed your default mouse modifier preferences (see Chapter 15) double-click on the MIDI item, or
- ◆ Select the MIDI item and press **Ctrl Alt E**
- ◆ Right-click on the item and choose **Open in built-in MIDI editor** from the menu.

However, exactly how the MIDI Editor will behave when opened will depend on your Preferences settings. Before delving into the MIDI Editor, therefore, we really need to explore these preferences. Use the **Options, Preferences** command, then choose **MIDI Editor** from the list to access the MIDI Editor preferences.

The wider range of MIDI Editor preferences is explored in Chapter 22. For now, we just need to focus on those shown on the right.

First, you can specify what by default will be opened with the MIDI editor. This can be **clicked MIDI item only**, **all selected MIDI items**, **all MIDI on the same track**, or **all MIDI in the project**. The default is **All selected MIDI items**.

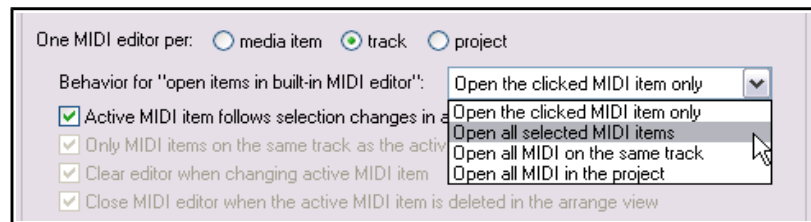

You can override the default settings at any time by opening the MIDI Editor by right-clicking on an item (or a selection of items) and choosing **Open items in editor**, then, from the sub-menu, choosing either **Open items in built in MIDI editor**, **Open MIDI item in editor** or **Open item copies in built-in MIDI editor**.

You can also determine what is to happen when more than one MIDI item is open: you can choose to have a separate MIDI editor instance **per media item**, **per track** or just one editor for the whole **project**.

13.6 The MIDI Editor Window

The next part of this User Guide focuses on how to work in the MIDI Editor with a single item. Later in this chapter we will look at working in the MIDI Editor with multiple items, and with items on multiple tracks. When you open an item in the MIDI Editor you will see a display similar to that shown below. It includes:

The Main Menu.

We'll take a detailed look at the main menu, its various commands and actions shortly: for now, note that if your MIDI Editor is docked, this menu is accessed by right-clicking on the windows docker tab. Meanwhile, you need to understand some more about the interface and how to navigate it.

The Toolbar(below Main Menu)

Hover your mouse over any button for a tooltip. You can customize this toolbar to meet your own requirements (see Chapter 15). The default toolbar icons are described below (left to right).

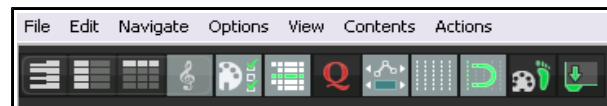

Select View Buttons

The first four buttons select which view will be displayed in the MIDI Editor. From left to right, these are **Piano roll** (the default), **Named note**, **Event list** and **Musical notation**. The first three of these are explained in detail throughout this chapter. Musical notation view is dealt with in the chapter following this one.

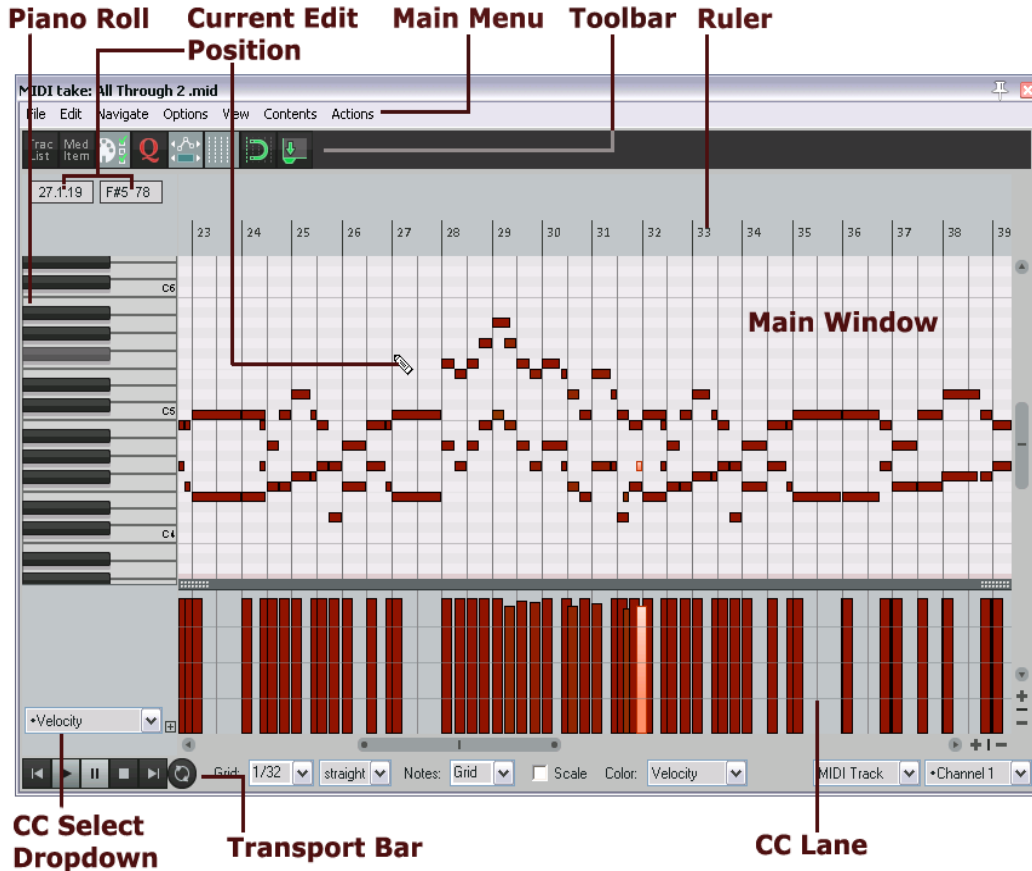

Filter Button

This is the third button on the toolbar. It opens the Filter Events window to allow you to decide what you want displayed in the MIDI Editor. The **Show only events that pass filter** box toggles your filter settings on and off. **Invert** causes all notes to be displayed *except* those defined by the filter settings. You can choose to display all **Channels**, or any combination or permutation of channels.

Enabling **Solo** will cause only events that pass through the filter to be played.

Use the **Event Type** drop down to select any type of event as a filter. The default is **All**, but you can choose Note, Poly Aftertouch, Control Change (CC), Program Change (PC), Channel Aftertouch, Pitch, or Sysex/Meta.

The content of the **Parameter** drop down lists depend on the event type selected. For example, for Note (as shown below), it will display a list of notes, with options to filter on note (optionally using the keys in piano roll) or note range, velocity, position in measure and/or length. However, choosing Program Change (PC) as event type will allow filtering only on program number and/or position in measure. Pitch can be filtered on low/high values or position in measure.

Position in measure behavior will vary with the event type. For example, if the event type is Note, position in measure allows you to restrict display to a range you define anywhere between 0 and 127. For PC, CC or Pitch, low and high position in measure values are set to any range within 1/32 and 1.

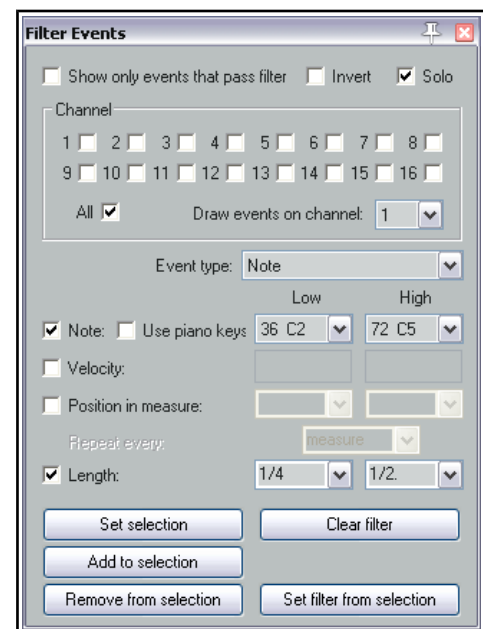

Up and Running: A REAPER User Guide v 5.24

Set selection causes current filter settings to be applied, and **Add to selection** lets you add to the existing filter selection. For example, you can create a filter on Note then add to it one based on Pitch. You can also specify settings to **Remove from (current) Selection**. **Set filter from selection** will automatically create a new filter based on the current MIDI Editor note selection.

The **Filter Button** includes a right-click context menu which can be used to toggle on/.off the options **Show only events that pass filter**, **Invert filter** and/or **Solo**.

Track List

This button opens (on) and closes (off) the Track List panel. This is explained in this chapter, in the section Working with Multiple Tracks and/or Items. For the time being, leave this set to off.

To the right of the track list button are six toggle icons, **Quantize** (on/off), **CC selection follows note selection**, **Show grid**, **Snap to grid**, **Step Sequencing** (use MIDI inputs for step recording, on/off) and **Dock editor**. Right-click over the Snap to Grid button to set behavior for when snap is enabled – **Always snap notes to the left**, **Snap notes to end of grid** (the default), or **Snap relative to grid**. The final icon **Dock editor** can be used to dock and undock the MIDI Editor window.

Note: If both Media, MIDI preferences to **Create new items as .MID files** and **Import existing MIDI files as .MID file reference** are enabled, the MIDI Editor toolbar will on the left display two further buttons - **File, Save MIDI file** and **File, Revert to saved MIDI file**.

Tip: The **View, Piano Roll Timebase** command includes the options source beats, project beats and project time. MIDI data is always defined in beat-based terms, but in the time view mode the grid is adjusted to reflect any tempo changes in the project. If there are no tempo changes, the beat and time views will be identical. You also have the option to select **Project synced**. This synchronizes the timeline of the project and MIDI item together. It also ensures that both windows are synchronized during such actions as zooming and scrolling.

The Ruler

The MIDI Editor follows your Arrange view settings. For example, if the option **Loop points linked to time selection** is enabled, click and drag along the MIDI Editor ruler will define both loop and time selection.

The Transport Bar

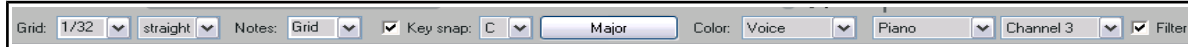

This is found at the bottom of the MIDI Editor window. It contains the transport buttons and a number of drop down lists. The six buttons (not shown) are self explanatory – left to right they are rewind, start, pause playback, stop playback, jump to end, and toggle repeat loop mode on/off. The loop area can be set on the timeline in either the MIDI Editor or the Arrange window. The drop down lists (shown above) from L to R are:

Grid: The grid division box is used to set the grid division unit, in notes. Select a values between 1/128 and 4.

Grid spacing type: Options here are straight, triplet, dotted or swing. If you choose swing, several other parameters will also be displayed on this bar. These are discussed later in the context of quantizing.

Notes: This is used to select the default note length (expressed as a fraction of a note) that is used when new notes are added. In the example above, this has been set to be the same as the grid setting. It can be overwritten using the main menu command **Options, Drawing or selecting a note sets note length**.

Scale and Chord: Enabling the key snap option allows you to select a scale and a chord from the two drop down lists. You can also use the chords button (here labelled "Major") to load a REAPER .reascale file.

Color: Uses color to display differences in **Velocity, Channel, Pitch, Source, Track** or **Media Item**.

Track List: Where more than one track contains MIDI item, this selects which track is to be made active in the MIDI editor. This can also be used to show or hide the track list panel.

Channel: Use this to select a channel from 1 to 16 for current editing (or All). The **Filter** box modifies selected channel behavior: when off, all channels are displayed, but the selected channel is still used for note entry.

The Main Window

The main window by default consists of two panels. The larger (top) panel displays your MIDI notes. Here you do your editing. The default view is Piano Roll View. Click on any piano key to play that note. The smaller (bottom) panel is the CC lane, used to display various information, such as note velocity or pitch.

Move your mouse over the main window area (where the notes are displayed) and you can see your mouse cursor displayed as a pencil. This indicates the **current edit position**, for example for inserting notes. Both the position on the timeline and that on the piano roll are shown in the top left corner, just beneath the toolbar.

The Scroll Bars

The MIDI Editor window includes vertical and horizontal scroll bars which can be used to navigate and zoom in and out of the contents of the MIDI item(s).

The CC Lane(s)

By default, **Velocity** information is shown in the CC lanes. To change this, *either*:

- Click on the drop down arrow (right) to see a menu of items (including standard MIDI control messages) that you can choose to display in the CC Lane instead of velocity. A small selection of the available choices are shown on the right, *or*
- Click on the small + button next to the drop down list arrow to add extra CC lanes. Select any item from the list to display in the selected lane.

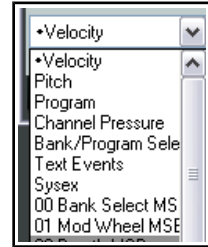
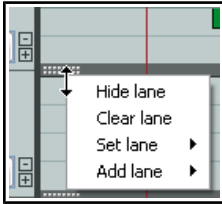

Right-clicking over the shaded area at the edge of the top border of a CC lane will produce a menu that can be used to hide a CC lane, clear it, change its contents (Set lane), or add an extra lane.

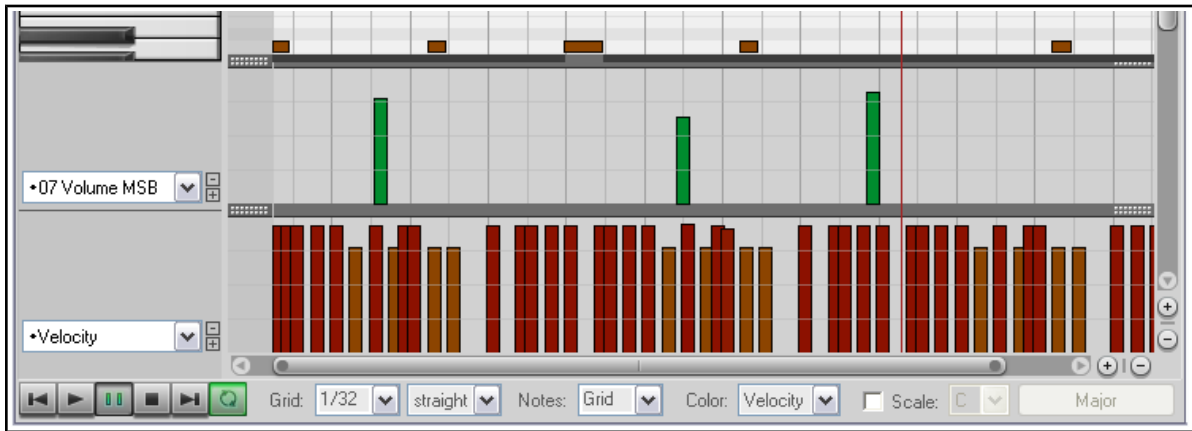

To remove a lane from view, click on the small minus sign that appears to the immediate right of its drop down arrow.

Provided the lane height is tall enough, the existence of CC messages can also be seen on the MIDI item in the main window (see right).

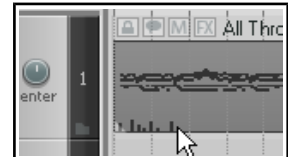

13.7 Control Change Messages

Control change messages are used to change the status of a MIDI parameter. If using an actual MIDI device, these messages can be used to physically control the foot pedals, volume sliders, modulation wheels, and other controls on electronic instruments. Within REAPER, control change messages can simulate this effect when playing back your MIDI data thru a software synthesizer.

Controller data is used for various purposes. The different controller data streams are numbered from 0 to 127. Some of these controller numbers are industry standard. For example, controller 7 is generally used to control volume and controller 10 for panning. A control change message has two parts. The first is the control change number, which determines which parameter is to be set. The second is the desired value for that parameter. For example, first, you might send a CC #7 message to specify that you want to adjust volume. Next, you send a value that sets the actual volume level required.

A control change message can act as either an *override* (setting the parameter to the exact value specified), or an *offset* (adjusting the parameter up or down by the amount specified).

MSB and LSB

MSB and LSB stand for *Most Significant Byte* and *Least Significant Byte* respectively. MSB control change messages typically act as coarse controls, while LSB messages generally allow fine adjustments. Some control

Up and Running: A REAPER User Guide v 5.24

change messages have both MSB and LSB versions. Most MIDI devices that contain sounds/patches respond to both Bank Select MSB and LSB control change messages.

Some of the more commonly used cc parameters are listed below. Don't worry if you don't understand them all. You should consult your MIDI device's documentation for more details.

Parameter	Description
Bank Select MSB Bank Select LSB	Many MIDI devices offer a total of more than 128 instruments, in which case these instruments are grouped into banks. Thus, depending on the device, a full program change message might consist of five parts – cc #0 (Bank Select), followed by the Sound Bank MSB value, then cc #32 (Bank Select LSB) followed by the Sound Bank LSB value, then finally the Program Change number. Program change numbers are discussed in more detail in the sub sections that follow after this one.
Velocity	The measure of the speed with which a key on a keyboard is pressed. A lane is also available for Note Off Velocity .
Mod Wheel	This can add vibrato or other changes to a sound.
Breath	Varies from 0 (no force) up to 127 (high force).
Portamento	Determines the smoothness of the glide from note to note
Balance	Typically used to adjust the volume of stereo parts without affecting the panning.
Expression	Used to create relative volume changes.
Sound Timbre	The property of a sound that gives it its unique "color".
Sound Release	Determines how long it takes for a sound to fade out.
Sound Attack	Controls how long it takes for a sound to fade in.
Sound Brightness	This adjusts a sound's filter cutoff, allowing you to create filter "sweeps".

13.8 Control Channel Basics

MIDI Data Control Channel (CC) messages can be recorded during live performance, and edited or manually entered using the CC lane in the MIDI Editor. The CC Lane appears at the bottom of the MIDI Editor. Data is displayed horizontally according to its position on the Timeline, and vertically according to the value of the data.

Most CC data has a value of 0 at the bottom of the CC Lane, and 127 at the top of the CC Lane. The example (right) shows Velocity. Exceptions to this rule include Pitch, Pan and Pan Position, which are displayed as positive or negative variations from a centre line.

The information displayed in the CC Lane is selected from the drop-down list at the left of the window. CC Data is entered or edited by dragging the mouse to the required value. To delete an event, select it, then press **Delete**.

The Mouse Modifiers page of REAPER's Preferences includes the ability to customize left drag and double-click behavior when working with MIDI CC events.

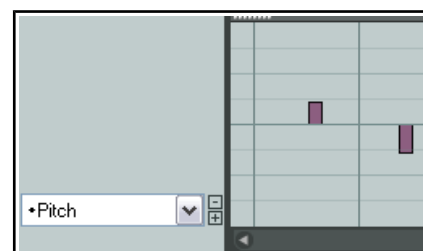
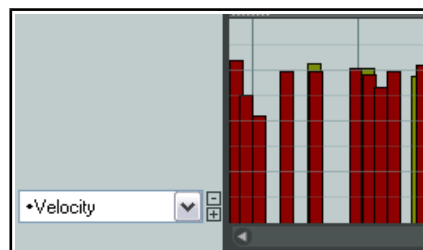

13.9 Working with MIDI Editor Lanes

There are a few especially interesting items that you can display in your lane or lanes that are not included in the above table. These are worth a special mention, because they might otherwise slip under your radar. They are System Exclusive messages, Text Events, and Bank/Program Select.

13.9.1 Sysex Events

System exclusive (Sysex) messages are MIDI data that can only be understood by the particular make and model of the device that created them. For example, all synthesizers should respond to CC messages like Volume or Pan control, but system exclusive messages created by a Roland synthesizer would not be understood by, say, a Yamaha synthesizer.

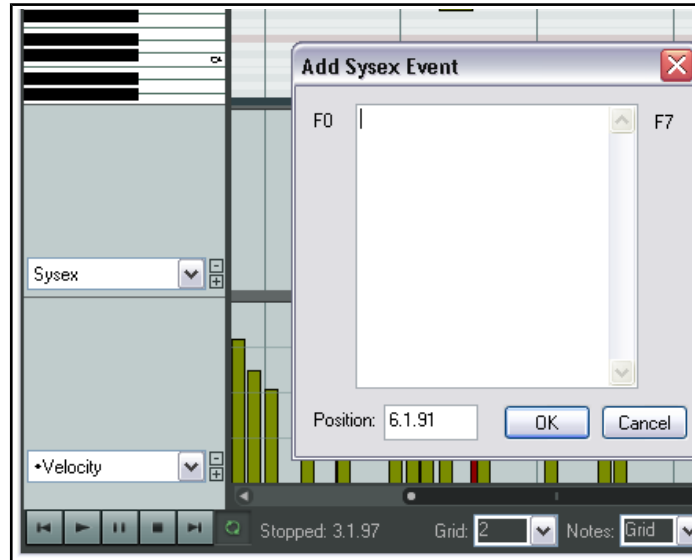

You can add a lane which can be used to manage system exclusive (Sysex) messages, as shown above. In this example, a Sysex lane is displayed in addition to a Velocity lane.

Some MIDI hardware, especially older devices, accept sysex messages as a way to initialize or change settings on the device. Sysex messages are raw MIDI data, represented as a list of hexadecimal bytes.

Sysex events may be added, edited, moved, or deleted in the same way as text events (see below). Double click in the lane to open the **Add Sysex Event** dialog box, enter the message and click on **OK**. Click, hold and drag on any sysex event to move it. Double click on any existing sysex event to edit it, or right click to delete it.

13.9.2 Text Events

The **Text Events** option lets you display a CC Lane which can be used to display text in a lane below your MIDI notes. These could be, for example, lyrics, or marker information or any of the other available text types.

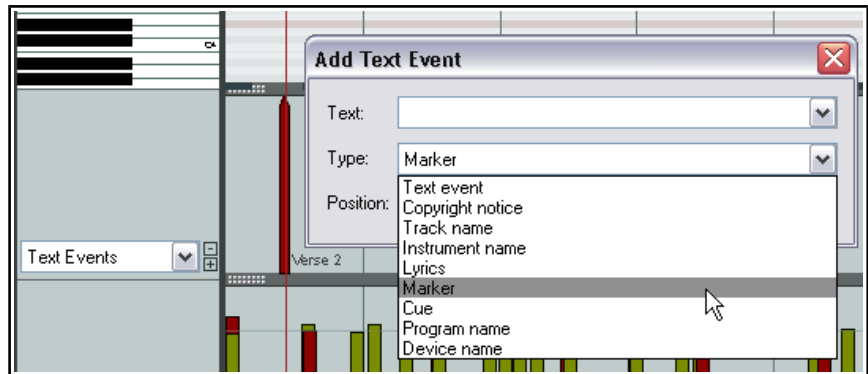

Just double click at any point in the lane to open the **Edit Text Event** dialog box, type your text, specify its type, and click on **OK**. As with system exclusive events, double click on any existing text event to edit it, drag it to move it, right click to delete it.

13.9.3 Bank/Program Select

When you choose the **Bank/Program Select** option for a CC lane, you can double click at any point to open the **Bank Program Select** dialog box.

Here you can select any bank/program combination, and assign it to any channel. The bank/program combinations available to you will depend on what instruments you are using (see example, right).

If using a synthesizer which has its own instrument definition files, you can load a file into the MIDI Editor by clicking on the **Load File** button, then navigating to its directory, then selecting it.

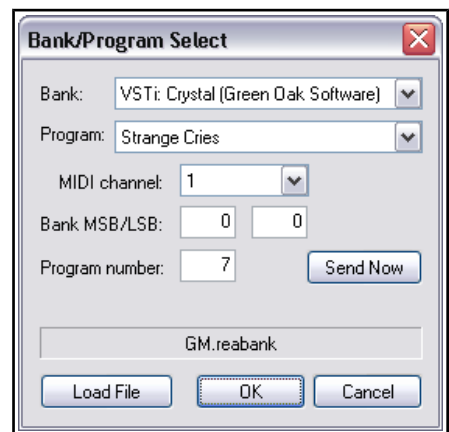

Up and Running: A REAPER User Guide v 5.24

An example of the use of program changes is shown here. To edit any program change message, just double click on its CC Lane bar. This will open the Bank/Program Select window for you to make your changes. Also, click and drag to move a program change message, double-click to edit it. To delete it, simply right click over its CC Lane bar.

13.10 MIDI CC Lanes: Tips & Tricks

REAPER's MIDI CC lanes include a number of additional features. Here are some that you might find useful.

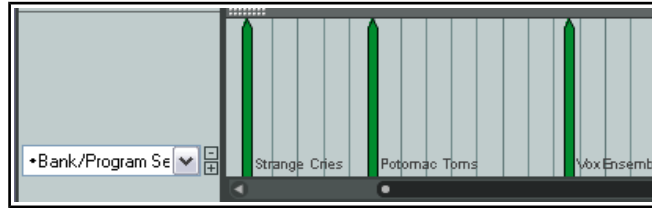

13.10.1 General CC Lane Editing Techniques

Many of the CC message types – such as Mod Wheel, Breath, Portamento, Pan, Volume etc. – can be expressed as a continuous range of values, rather than as discrete items (in the way that text events, for example, are). For messages of this type there are a number of standard techniques you can use to enter, edit or delete them.

- To enter a single message, click and move (gently push) the mouse in the appropriate CC lane at the required point. The nearer the top of the lane, the higher the value of the message.
- To change the value of an existing message, click and drag it up or down.
- To delete a message, right click over it. Alt right click sweep will delete a series of messages.

You can click-hold-drag-sweep to insert a continuous sequence of messages. The example shown (right) causes the notes to be panned in increments first to the left, then to the center, then to the right, then back to the center again.

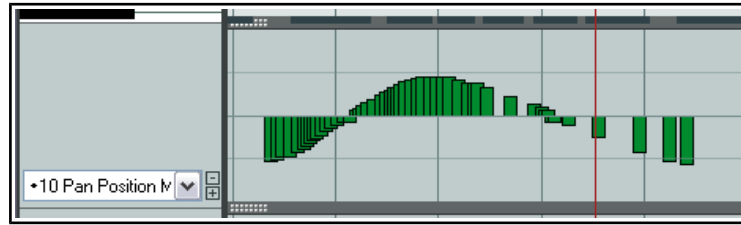

13.10.2 Right Click Marquee Selection

You can right-click and drag within any CC lane to make a selection of multiple events. Having made your selection, you can work with them in the CC lane, as well as (if appropriate) in the piano view window. For example, if the CC lane displays Velocity, then there will be one event shown in the CC lane for each note in the piano view. Selecting the events in the CC lane will also select the corresponding notes in the piano roll view.

You could then work with those selected events in the MIDI Editor or work with them in the CC lane itself. For example you can:

- Delete them.
- Adjust their values (up or down).
- Right click over the CC lane for a context menu (see right). This can be used to nudge or move the selected events.
- Click and drag to move the selection left or right, control click and drag to copy.

The exact behavior here will be determined by whether the individual CC events are directly linked to individual note events. In the example shown here, this would be the case with the velocity events but not the pitch change events. Thus, in the former case (velocity) you would need to move the events in the piano view window itself and the velocity events would move with them. In the latter case (pitch changes), you would move the events in the CC lane itself.

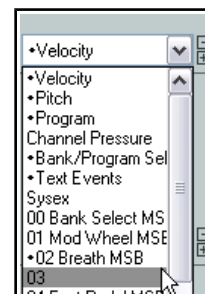

13.10.3 Intelligent CC Lane Dropdown List

The CC Lane dropdown menu uses markers to show which other lanes already exist and contain data, whether they are currently displayed or not. In the example shown here, this applies to Velocity, Pitch, Program, Bank/Program Select, Text Events and Breath.

13.10.4 14-bit CC Lanes and Actions

The CC Lane drop down menu includes a complete range of options for 14-bit CC messages. These can be found at the end of the drop down list. There are also actions that can be used to select any message type for any lane. Use of the Actions List Editor is explained in detail in Chapter 15, but in brief:

1. From the MIDI Editor **Actions** menu choose **Show action list ...**
2. In the Action List, select one of the actions **CC: Set CC lane to ...** (e.g. *Set CC lane to 007 Volume 14-bit* or *Set CC lane to 007 Volume MSB*). You can now assign a shortcut key to that action (see Chapter 15). Close the Action List Editor.
3. Now you can at any time select a MIDI Editor CC lane and use the shortcut key to use that CC lane for the chosen message type: existing data will be displayed and new data can be inserted and/or edited.

13.10.5 Resizing CC Lane Height

You have three options for changing the height of CC lanes. All involve clicking on the dotted "handle" (shown here) on the "ceiling" boundary above the CC lane in question. The mouse cursor becomes a vertical double-headed black arrow. You can then drag the mouse up or down. When you have only one CC lane displayed all three actions do exactly the same thing. However, when there are two or more CC lanes shown, these three actions will behave differently.

Click and Drag: Simply click and drag up/down to increase/decrease the portion of the MIDI Editor window used to show the selected CC lane. Increasing this portion will decrease the height of the piano roll window and vice versa. Other CC lane heights remains unaffected.

Shift Click and Drag: Shift click and drag up/down will increase/decrease the height of all CC lanes and adjust the height of the piano roll window accordingly.

Control Click and Drag: Control click and drag will adjust the height of just the one CC lane, leaving other CC lane heights unchanged.

In addition, you can double-click on the dotted handle (also known as "grippy area") of any open CC lane to toggle between viewing and minimising it.

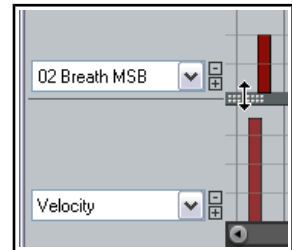

13.11 Navigating the MIDI Editor Main Window

The MIDI Editor's menus and action list contain any number of techniques that you can use for precision navigation: we'll get to these shortly. First, you should familiarise yourself with the tools that you have available for "broad brush" navigation. The horizontal and vertical scroll bars in the MIDI Editor window are used for scrolling, and their respective plus and minus buttons can be used for vertical and horizontal zooming. You can also use your mousewheel. This can be customized in the Actions List Editor (see Chapter 15), but by default the settings are:

Mousewheel: Horizontal Zoom **Ctrl Mousewheel:** Vertical Zoom
Alt Mousewheel: Horizontal Scroll **Ctrl Alt Mousewheel:** Vertical Scroll

The keyboard shortcuts **PageUp** and **PageDown** can be used to zoom in/out vertically, and **+** and **-** to zoom in and out horizontally. These too can be changed in the Actions List Editor if you wish.

13.12 Basic Note Selection and Manipulation

The MIDI Editor's menus and action list contain any number of techniques that you can use for precision editing and manipulation of your notes: we'll get to these shortly. First, you should familiarise yourself with the most basic tools that you have available for quick and basic editing.

To do this ...	You need to do this ...
Add a note	Click and drag in the MIDI editing area.
Delete a note	Double-click on the note.
Select a note for editing	Click once on the note.

To do this ...	You need to do this ...
Select a range of notes	Right click and drag around the selection.
Select all notes in a range	Right click and drag keys in piano roll.
Add to an existing selection	Hold Alt and Ctrl while right clicking and dragging around notes.
Change a note's length	Hover mouse over the start or end of the note - the mouse cursor is now a double headed black arrow. Click and drag left or right , as required.
Move a note	Click and drag note to new position then release.

13.13 Loop/Time Selections and Smart Editing

To move the position of the cursor, click on the timeline (ruler) in the MIDI Editor window.

Loop and time selection within the MIDI Editor will behave in accordance with whether or not you have enabled the option **Loop points linked to time selection** on REAPER's main menu. These notes assume that you have this disabled.

You can select an area to be looped, as in the main REAPER window, by clicking and dragging along the MIDI Editor timeline. You can also use the REAPER arrange view timeline to define and modify loop areas if you wish. Use the **Toggle Repeat** button on the MIDI Editor Transport Bar to enable or disable looping.

To make a time selection, click and drag along the boundary between the piano roll display area and the CC lane. The mouse cursor becomes a horizontal double-headed arrow. Notice that the time selection is mirrored in REAPER's Arrange view (see right).

This facilitates smart editing (see Chapter 7). For example, within the docked MIDI Editor window you could work on the part of a MIDI item that you wish to copy or move to another track and then, still in the MIDI editor, mark that as a time selection.

In Arrange view, you could then **Ctrl Click Drag** that area to another track (or elsewhere on the same track) and create your copy. If using this feature, you should first decide whether or not you wish to enable **Auto-select CC when moving/copying within time selection** from the **Options** menu.

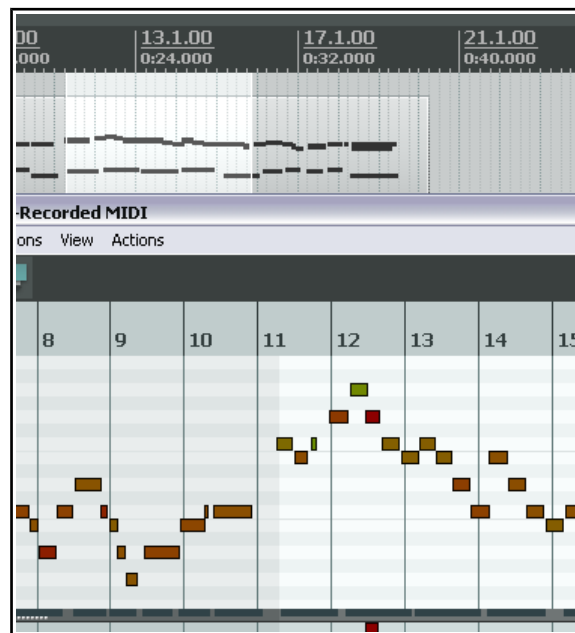
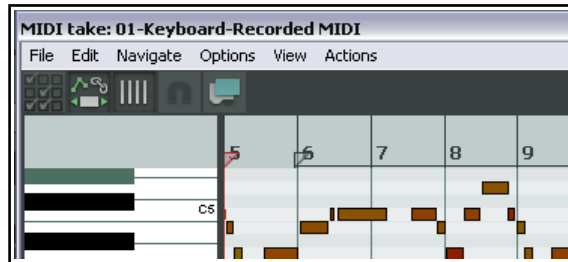

13.14 The MIDI Editor Menus

This section is an overview of the MIDI Editor's main menu commands. When docked, the main menu is not displayed, but you can access these commands by right-clicking over the window's tab in the docker. You can also access the MIDI Editor menu by right-clicking just above the piano keys or timeline.

The File Menu

Rename MIDI take ...

Renames the MIDI Item.

Export to new MIDI file ...

Exports active MIDI track to a file. MIDI events are normally stored in the Project file itself.

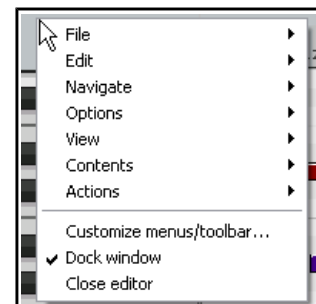

Notation: Export as MusicXML

Available in musical notation view only – see next chapter.

Note names

Displays a sub-menu. **Rename current note...** Use this in Piano Roll or Named Notes mode to name the currently selected note. After entering a name you can use **Tab** to move to the next note in the piano roll, **Shift Tab** to go to the previous note.

Load note names for active channel..., **Load note names for all channels....** Select either of these options, then choose **From file...** to browse for your required file. Recently used files will also be displayed on the menu. When loading from the recent file list, hold **Shift** with this command to merge imported names with existing note names rather than replace them.

Notice there is an option to **Clear existing note names before loading.**

Another option is to **Save note names for current channel to file...**

Finally, you can also **Clear note names for active channel** or **Clear note names for all channels.**

Note colors

Displays a sub-menu. **Load color map from file .../Clear color map (use defaults).** Used to import your own .PNG color map file or restore the REAPER defaults. For more information about how to create a color map file, go to forum.cockos.com/showthread.php?t=78839

Close Editor

Closes the REAPER MIDI editor, and returns you to the main REAPER window.

The Edit Menu

Undo, Redo, Copy, Cut, Paste, Select all events, Delete

These features work as expected on all selected MIDI notes. Note that you can cut, copy and paste between MIDI Editor windows, and into some external applications.

Paste, Paste preserving position in measure

Paste will paste to the current cursor position. Where a selection of notes (rather than a single note) has been cut or copied, the entire selection will be pasted starting at the current cursor position.

Paste preserving position in measure pastes to the next measure after the cursor position, retaining the relative position of the item pasted.

Mute

Mutes current note selection.

Insert note

Inserts new notes at the Edit Cursor.

Split notes

Splits selected notes (using the S key). If no notes are currently selected, all notes currently under the Edit Cursor are split.

Join notes

Joins selected notes together.

Set note ends to start of next note (legato)

Sets ends of selected notes to start of next notes by adjusting end points of all notes in selected range.

Make notes sequential

Lengthens or shortens notes (as necessary) so that each note starts precisely as the one before it ends.

Quantize ...

Opens Quantize Events dialog box. See the *Quantize* section and the MIDI Toolbox section for more information about this feature.

Quantize submenu:

Quantize using last settings

Quantize position to grid

Unquantize

Freeze quantization

See the *Quantize* section and the MIDI Toolbox section for more information about these command.

Humanize ...

Opens the dialog box shown here. Humanizing can make the exact timing of MIDI generated music sound less "clinical" and more realistic.

It does so by allowing you to introduce random small and subtle imprecisions in timing and velocity. As well as being found on the **Edit** menu, this command is also available as an assignable action.

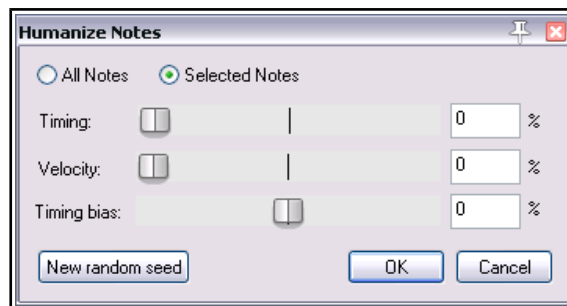

Transpose ...

Opens the dialog box shown here, which can be used to transpose all or a selection of MIDI notes. You can transpose by a specified number of semitones, with a snap to scale option, or from one specified key/scale to another.

The Navigate Menu

This menu presents a number of options for moving notes in any direction, either by grid or by note:

Move cursor left by grid **Move cursor up one note**
Move cursor right by grid **Move cursor down one note**

The following commands can be used to jump to and select a note, either instead of or in addition to any current selection:

- Select note nearest cursor**
- Add note nearest cursor to selection**
- Select previous note**
- Select next note**
- Select previous note with same pitch**
- Select next note with same pitch**
- Select all notes with same pitch**
- Add previous note to selection**
- Add next note to selection**
- Move edit cursor to start of selection**

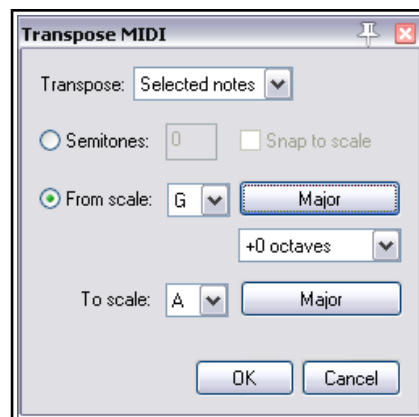

The Options Menu

Dock window

Moves MIDI Editor to the Docker. The MIDI Editor's main menu will no longer be displayed. This menu can then be accessed by right-clicking over the window's tab in the docker (right).

Sync editor transport to project transport

Synchronizes MIDI Editor transport to REAPER's main Timeline.

Use the same grid division in arrange view and the MIDI editor

This makes the displays in arrange view and the MIDI editor consistent with each other.

Chase MIDI note-ons in project playback

When playback starts anywhere other than at the very start of a project, notes that begin just before the playback position might not be heard. This could be the case, for example, if you start playback in the middle of a long note. Leaving this option on prevents this from happening.

Time format for ruler, transport, event properties

Gives you the choice of Measures.Beats.100ths or Measures.Beats.MIDI_ticks.

Snap Settings

Displays a sub-menu of snap toggle options: **Snap notes/CC to grid**, **Soft snap notes to other notes**, **Always snap notes to the left**, **Snap note ends to grid** and **Snap notes relative to grid**.

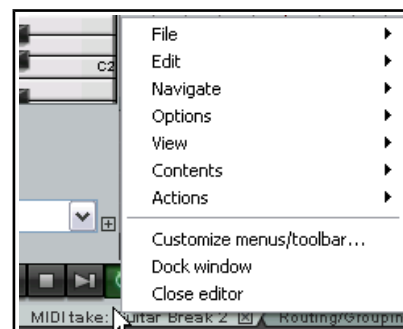

Note preview

Displays a sub-menu enabling you to select any or all of four situations when you would like notes to be previewed (.i.e. audibly heard) – **Preview notes when inserting or editing**, **On velocity change**, **On keyboard action**, and/or **All selected notes that overlap with selected note**.

CC events in multiple media items

Two options are available, either of which can be enabled if you wish. These are **Draw and edit on all tracks** or **Edit on all tracks**.

Drawing or selecting a note sets the new note length

Over-rides the default note length set by the drop down Notes box on transport bar.

Allow MIDI note edit to extend the media item

If enabled, this toggle will ensure that the media item length will be extended when a note is moved or copied within a time selection.

Auto-select CC when moving/copying within time selection

If enabled, will include CC events when a time selection is copied or moved.

Display 14-bit MSB/LSB CC data as a single entry ...

If enabled, ensures that 14-bit MSB/LSB CC data will be shown as a single entry (rather than separate entries) in event list view and properties,

Automatically correct overlapping notes

Toggles on and off the automatic correction of overlapping notes.

Use F1-F12 as step sequencer (see also section "Step Recording")

When enabled, the function keys (F1 - F12) can be used to enter notes. These keys are mapped to the 12 Semitones of an Octave, with F1 having the lowest pitch and F12 having the highest pitch. The starting pitch for F1 is set by the location of the highlight bar. In the example shown (right), the starting pitch for F1 is C6. In this case, pressing (for example) F5 will create an E note. By moving the highlight bar and edit cursor, and using function keys to enter notes, complete arrangements can be quickly created.

Normally this mode will also advance the cursor according to the snap settings. You can bypass this by holding **Shift** while pressing the function key.

Use all MIDI inputs for step recording

Toggles the use of MIDI inputs when step recording.

MIDI editor mouse modifiers

Opens the mouse modifiers page of your preferences window. Here you can select actions to be assigned to mouse behavior in various contexts. This is discussed later in this chapter and in Chapter 15.

Customize menus/toolbars ...

Opens the Customize Menus/Toolbars window. See Chapter 15.

The View Menu

Filter events..., Quantize..., Humanize..., Transpose ...

Opens one of these dialog boxes, which are individually discussed elsewhere in this chapter.

Event properties ...

Opens the Note properties dialog box. This topic is covered later in this chapter.

Raw MIDI data

Opens a window displaying raw MIDI data for currently selected item.

Mode: piano roll

Displays a standard, white/black piano key view. This is the mode most commonly used for MIDI editing.

Mode: named notes

Replaces the Piano Roll view with note names. Note: Only works when using a VSTi that reports note names, such as Fxpansion's BFD. Check the REAPER forum to see if a note namer plug-in has been posted for the VSTi you want to use. For example there are EZDrummer note namers available.

Mode: event list

Displays the event list. This is explained later in this chapter.

Mode: musical notation

Displays MIDI notes in musical notation view. See next chapter.

Up and Running: A REAPER User Guide v 5.24

Piano roll notes

Displays a sub menu of **Rectangles**, **Triangles** and **Diamonds** to determine how notes are displayed. There are toggle options to **Show velocity handles on notes**, **Show velocity numbers on notes** and/or **Show note names on notes**. In the example shown, velocity handles and note names are displayed.

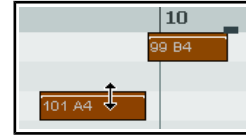

Color notes by

This command selects the criteria used for coloring notes. The options are **Velocity**, **Channel**, **Pitch**, **Source (using color map)**, **Track** and **Media item**. You can toggle on/off **Show color selector in editor**. You also have options to **Load color map from file** and **Clear color map (use defaults)**.

Show/hide note rows

Displays a sub-menu with three options: **Show all note rows**, **Hide unused note rows**, or **Hide unused and unnamed note rows**. The hide options are not compatible with piano roll view.

Piano roll ruler

Provides options to display or hide **project markers**, **project regions** and/or **tempo/time signature markers** on the piano roll ruler. These are displayed above the ruler, and tempo/time signature markers can be edited by double-clicking on them. You can also right-click for a context menu.

Piano roll timebase

Sets the timebase for the piano roll. Options are **Source beats** (from media source item), **Project beats**, **Project time**, or **Project synced**. For more information, choose **Timebase help** from this menu.

Notation view options

Displays a sub-menu of various options that are only relevant when working in notation view. These are explained in the chapter immediately following this one.

The Contents Menu

Track List/Media Item Lane

Toggles the display of these panels which list and display tracks and MIDI items respectively.

One MIDI editor per

Opens sub menu where you can specify one MIDI editor window for each item, each track, or the project.

Behavior for "open items in built-in MIDI editor"

Select whether opening items in arrange view, using the media item menu, should **Open the clicked item only**, **Open all selected MIDI items**, **Open all MIDI items on the same track as the clicked item** or **Open all MIDI in the project**.

Options when using one MIDI editor per project

Opens sub menu where you can specify various options which determine how REAPER behaves when you are using one MIDI editor per project. See section "Managing Multiple MIDI Tracks and Items."

List of project tracks/MIDI items

This menu lists all tracks which contain MIDI items and all items themselves. A tick indicates that the item is currently open and the active item. Select an item from this menu to open it in the MIDI Editor window, closing all other items: hold Shift while doing so if you do not wish to close all other items.

The Actions Menu

This has two default commands - **Show action list** and **Show recent actions**. **Show action list** opens the **Actions ...** window with the **MIDI Editor** section automatically selected. Custom actions and keyboard shortcuts play an important role in working within the MIDI Editor.

When **Show recent actions** is enabled, the Actions menu will list your most recent activities, as well as any custom actions or keyboard assignments that you have placed there. These commands can then be executed from this menu (see example, right). There are some simple examples showing you how you can use the Actions List later in this chapter. The **Actions List Editor** is covered in detail in Chapter 15.

Remember that REAPER makes extensive use of right-click context menus. Knowing which commands are on the main menu is useful, but often you'll find using the right click menu easier.

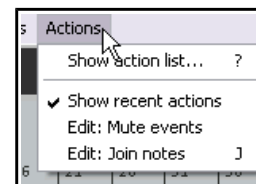

13.15 Note Creating and Editing

Overview

A MIDI Item can contain data from up to 16 channels. The MIDI Editor can display and edit all 16 MIDI channels, or you can use the Filter Events window or Channels drop down list to limit the channel display.

If you select Channel from the Color drop down list, each channel will be assigned an individual color, visible in both the Piano Roll and the CC lane. The MIDI Editor uses as its default a Piano Roll interface to display and edit MIDI information. Notes are displayed vertically according to their corresponding value on a Piano Keyboard, and horizontally according to the duration of each note and their location within the MIDI Item or the Timeline.

Preview Keyboard

The Preview Keyboard at the left of the screen provides a visual representation of the value of the notes on the Piano Roll, and allows you to audition a note without having to enter or edit it first. Clicking a key on the Preview Keyboard will send a MIDI note of the corresponding value to the MIDI Instrument that is connected to the Track. The Preview Keyboard can mimic a velocity sensitive keyboard. Clicking on the far left of a key will generate a soft note, while clicking on the far right of a key will generate a loud note.

Entering / Editing Notes

MIDI notes can be recorded as part of a performance, imported from an existing MIDI file, or they can be manually entered using the MIDI Editor.

Using the Mouse:

Notes can be entered by dragging your mouse from left to right across the Piano Roll. The duration of the note will increase as you drag the Note. If Snap is enabled, the duration will Snap to the nearest Grid Line (depending on the strength of your Snap settings). Notes can also be entered by double-clicking on the Piano Roll (in a space not already occupied by another note). In this case, the duration of the note is determined by the value of the Grid Setting. Notes can be deleted by double-clicking on the Note.

The duration of an existing note can be altered by dragging the edge of the note. While holding it, you can drag the note out, move it up and down, etc. When you let go, the notes will be positioned according to your snap setting. A note's velocity can be adjusted by clicking and dragging up or down from the top of the note, in similar fashion to that used for adjusting the item volume button or handle in REAPER's main window.

Notes can be moved by dragging in any direction. Dragging left or right will change the location of the note in the Timeline, while dragging up or down will change the note value.

The Right-Click Notes Menu

Copy/Cut/Paste

These are standard Windows editing commands which perform standard Windows functions.

Paste preserving position in measure

This pastes notes to the next measure after the cursor, retaining the relative position of the item(s) pasted.

Select all

Selects all notes in this MIDI Editor window

Delete

Deletes all notes in current selection.

Mute

Mutes according to context the current note selection or the note under the mouse cursor.

Insert note

A very quick way to insert notes. It will insert notes according to the current snap values at the edit/play cursor position.

Split notes

Notes can be split at the Edit Cursor by selecting **Split notes (S)** from the right-click menu. All notes that are under the Edit Cursor will be split.

Join notes

Joins all notes in current selection to make one note per row.

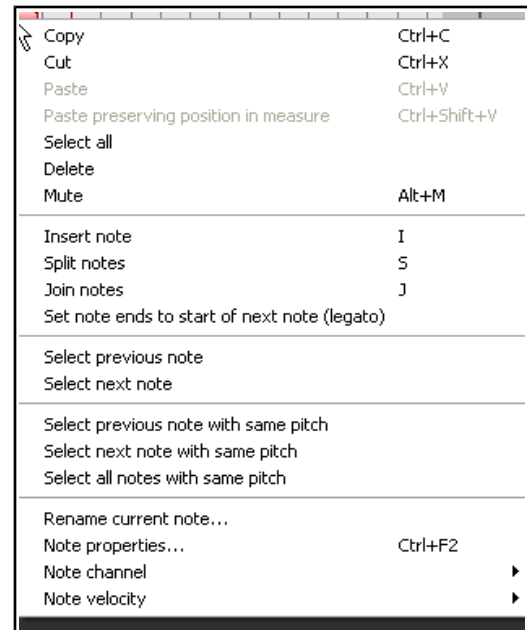

Set note ends to start of next note

Extends the end of each note in a selection to the start position of the next note in the selection.

Select previous note

Select next note

Selects previous or next note in place of current selection.

Select previous note with same pitch

Select next note with same pitch

Select all notes with same pitch

Selects previous, next or all notes with the same pitch as the currently selected note.

Rename current note

Allows you to rename in the piano roll the note underneath the mouse cursor.

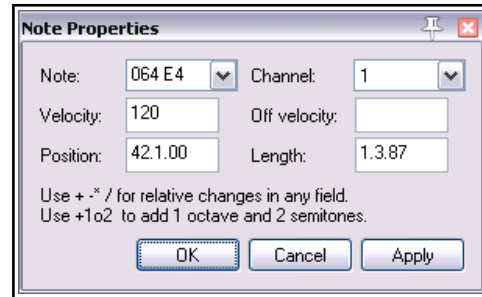

Note properties

Midi note attributes can be edited by entering values into text boxes. You can change any of these: **note pitch, velocity, position, channel, note off velocity, length.**

You can use + or - to make relative changes. For example, for note value, entering +1o2 will raise the pitch by one octave and two semitones.

Note channel (1-16)

A quick way to change the channel for the current note selection. For example, choosing channel 8 will ensure that a note will use channel 8 -- and will send that note to the vsti or midi instruments channel 8.

Note velocity (1-127)

Used to change the velocity for a note or note selection to a specified value, within the range 1 to 127.

13.16 Using the Keyboard

Looking at the right click Notes menu you can see that default keyboard shortcuts have been assigned to many of these commands. There are others that are not shown on the menus. Some of the most useful of these are listed here.

Notes can be entered at the position of the edit cursor by using the Keyboard Shortcut **I** or at the mouse cursor by pressing **Insert**. The duration of the note will be determined by the value of the grid setting (from the Grid Division box). The effect of this is shown in the two illustrations (right), before and after.

The **Edit Cursor** position on the Timeline is adjusted by using any of the following Keyboard Shortcuts.

To do this use this shortcut
Move edit cursor right by one grid division.	Right or Ctrl Num 6
Move edit cursor left by one grid division.	Left or Ctrl Num 4
Move edit cursor right by one pixel.	Shift Right or Ctrl Alt Num 6
Move edit cursor left by one pixel.	Shift Left or Ctrl Alt Num 4

Notes can be **moved** using any of the following Keyboard Shortcuts.

To do this use this shortcut
Move selected note(s) down one octave.	Alt Num 2
Move selected note(s) down one semitone.	Num 2
Move selected note(s) up one octave.	Alt Num 8
Move selected note(s) up one semitone.	Num 8
Move edit cursor left by one pixel.	Alt Num 4
Move edit cursor left by one grid unit.	Num 4
Move edit cursor right by one pixel.	Alt Num 6
Move edit cursor right by one grid unit.	Num 6

13 - Manipulating and Editing MIDI Items

Note display can be **filtered** for channels 1 to 10 using any of the shortcuts **Shift 1** thru **Shift 0**. **Shift `** removes the note filter and restores all notes to view.

Use F1-F12 as step sequencer:

When **Use F1-F12 as step sequencer** is selected, the Function keys F1 thru F12 can be used to enter notes. The Function keys are mapped to the 12 Semitones of an Octave, with F1 having the lowest pitch and F12 having the highest pitch. The method for using this is the same as already described under the MIDI Editor's main **Options** menu.

Note Properties:

The keyboard shortcut **Ctrl F2** can be used to open the Note Properties box, as an alternative to choosing the command from the right-click menu.

Selecting / Editing multiple Notes:

Multiple notes can be selected by holding down the Ctrl or Shift keys while selecting notes with the mouse, by drawing a Marquee (Right-click and drag) around a group of notes, or by using Select All (**Ctrl A**).

- ◆ The value of all selected notes can be adjusted by dragging one of the selected notes.
- ◆ The duration of all selected notes can be adjusted by dragging the edge of one on the selected notes.
- ◆ The note velocity of all selected notes can be adjusted by dragging the Velocity handle (when active) of one of the selected notes.

The default Velocity value for notes created in the MIDI Editor is taken from the last selected event - e.g. if the Velocity of the last selected event was 70, then the Velocity value for the next created note will be 70.

13.17 Transposing Notes

As an alternative to using the **Edit, Transpose** command to transpose MIDI notes you can use a number of keyboard shortcuts. First select the required notes, then use one of the following shortcuts:

Move notes up one octave

Alt NumPad 8

Move notes up one semitone

Ctrl Up or **NumPad 8**

Move notes down one octave

Alt NumPad 2

Move notes down one semitone

Ctrl Down or **NumPad 2**

13.18 General MIDI Program Patches

We have already seen that you can use a Bank/Program Select lane to make program changes within an item. It's worth noting that REAPER includes a file GM.reabank (in the \Application Data\REAPER\Data folder) which can be used to select standard General MIDI banks and patches. An example is shown here.

If the General MIDI banks are not automatically available in the Bank drop down list, click on the **Load File** button, navigate to the REAPER data directory and select the file **GM.reabank**.

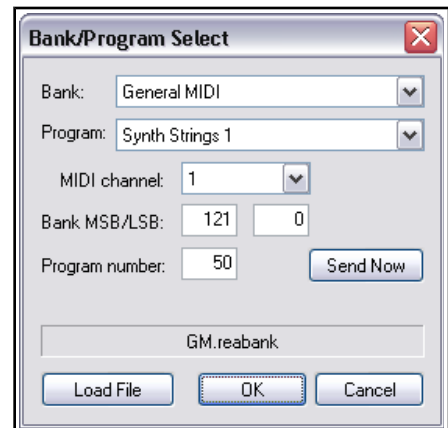

13.19 MIDI Preview Scrub

Within Piano Roll View and Named Note View you can preview your MIDI material by clicking and dragging the edit cursor along the timeline. This is similar to audio scrub: exact scrub behavior will be determined by the settings under **Options, Preferences, Audio, Playback**.

13.20 MIDI Editor Modes and Views

13.20.1 Note Modes

The MIDI Editor has three modes, accessible from the **Views** menu.:

1. **Piano Roll View** – keyboard shortcut **Alt 1**.
2. **Named Notes** – keyboard shortcut **Alt 2**.
3. **Event List** – keyboard shortcut **Alt 3**.

Up until now, the only view used in this User Guide has been Piano Roll. Before moving on to examining the other two views, there are a couple of points that you might find interesting.

Named Notes Mode:

In this mode you can double right click in the left pane to enter text, as shown. If you select the option on the View menu to **Show note names on events**, then the names will be shown on the actual notes themselves, as shown here.

If you leave this option enabled, the names will also be displayed in **Piano Roll View**.

In named note mode, you also have the options (View menu) to **Show all note rows**, **Hide unused note rows** and **Hide unused and unnamed note rows**. The first of these options is the default.

Hiding unused note rows can make it easier for you to navigate thru the MIDI Editor to work with existing notes. However, problems may occur if you then want to add or move notes to rows that are currently empty. The option to **Hide unused and unnamed note rows** can help you to get round this. By taking the time *before* you choose this command to name any empty rows that you are likely to need, you will ensure that these rows will still be available to you.



Event List Mode:

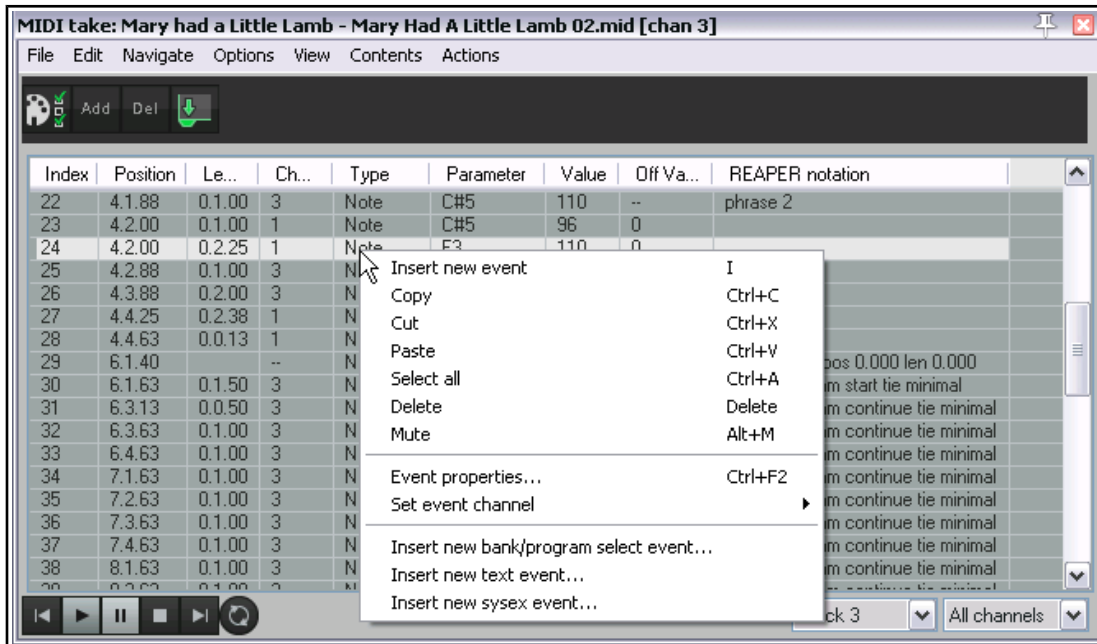

Event List mode displays the MIDI information as a list of events, in tabular form. In this mode you can use the right click menu (shown left) to (for example) insert, copy, cut paste, delete or mute any events.

The full menu is shown here.

13 - Manipulating and Editing MIDI Items

You can also double click on any event to modify that event's properties (see example below right).

Of course, the information displayed in the Event Properties dialog box will in large measure depend on the event type of event.

The Toolbar displayed in Event List view is simpler than that used in the other two views. The **Filter** button (top left) is used exactly as in the other two views to filter only those events that you want displayed. The **Add Event** button will insert a new event immediately before the currently selected event, and the **Delete** button will delete the currently selected event. The fourth button toggles the docking of the MIDI Editor on and off.

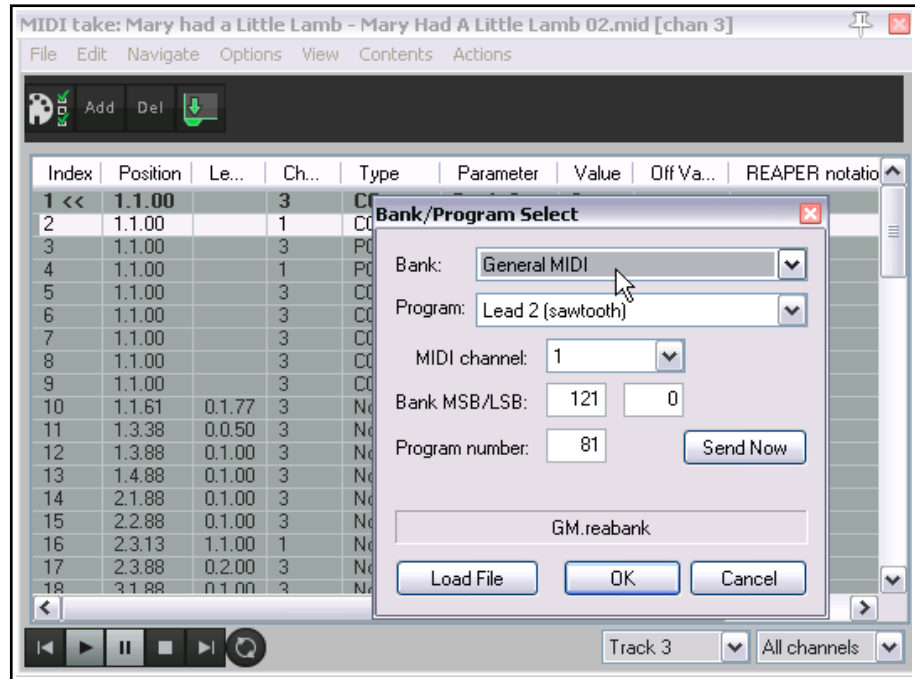

Note: From the **Options** menu, the toggle command to **Display 14-bit MSB/LSB CC data as a single entry in event list view and event properties dialog** is by default enabled. This causes 14-bit MSB/LSB CC data to be shown as a single entry rather than separately.

13.20.2 Note Styles

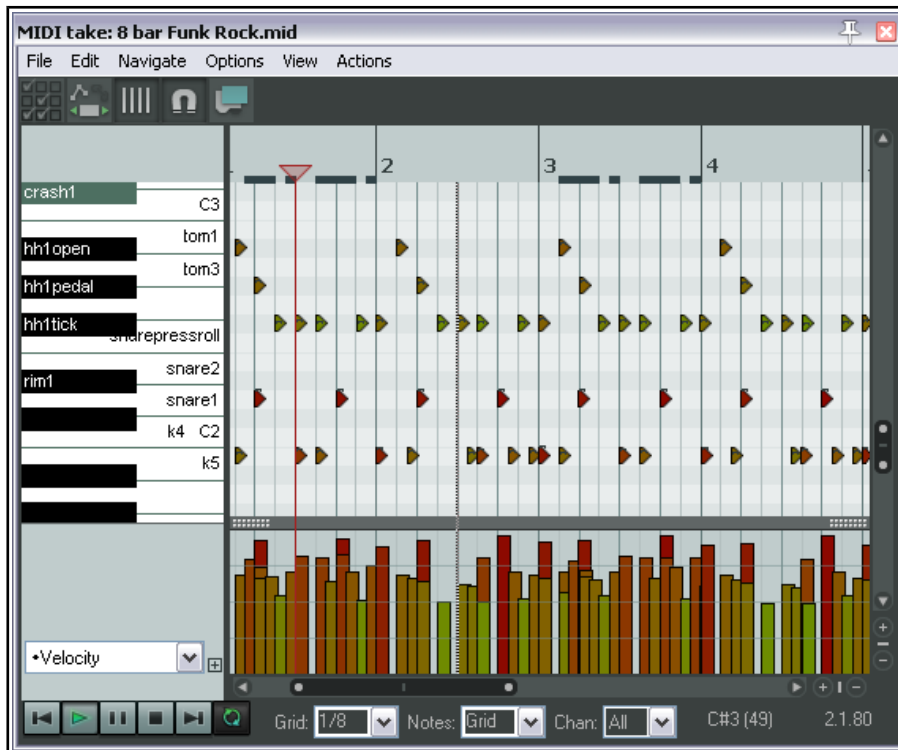

The default display note style used by the MIDI Editor is rectangular. This is the style that has been displayed in all of the Piano Roll View and Named Note View examples up to now. However, two further options are available, specifically for use with drum sounds.

These are triangle and diamond modes. To choose a note style, use the **View, Piano Roll Notes** command and select **Rectangle, Triangle** or **Diamond**.

An example which uses triangles instead of the default rectangles is shown on the left.

13.21 Quantizing MIDI Data

The term **Quantize** refers to a process of aligning a set of musical notes to a precise setting. This results in notes being set on notes and on exact fractions of notes. When you quantize a group of MIDI notes, the program moves each note to the closest point on the timing grid.

The point of quantizing is to provide a more uniform timing of sounds. It is often applied to MIDI notes created by a musical keyboard or drum machine. Quantize is available by choosing the **Edit, Quantize events** command from the MIDI Editor menu. This causes the dialog box shown on the right to be displayed.

The first choice you have is between the **Use Grid** and **Manual Settings** option. We'll come to Use Grid shortly. Shown right is the dialog box interface that appears when the Manual option is selected. The various quantize parameters are explained below.

Notice the **Bypass** option (top right). Disabled it lets you see the result of different quantize parameter settings as you tweak them. Enable this until you are finished if you don't want this to happen. Toggle it if you want to compare how your music sounds with and without quantizing applied.



All Notes, Selected Notes, All Events or **Selected Events**. The first Quantize drop down list allows you to quantize selected notes or events (not just notes) or the whole sequence (all notes or all events). This can come in handy if you just need to quantize a certain off section, or perhaps just a certain instrument, such as the hi-hats of a drum section. The second Quantize drop down list works in conjunction with whatever selection you make from the first. You can choose to have the quantizing of notes and/or events applied to the **Position** only, **Position and Note End**, **Position and Note Length**, **Note End Only** or **Note Length Only**.

The **Strength** setting adjusts how strictly notes are quantized. The lower you set the strength, the less 'magnetism' the grid has to the midi notes. This introduces subtle imprecisions to the quantizing which can make the outcome seem less clinical.

The **Grid** and **Length** values determine which units (measured as fractions of a note) are used for quantizing. These can be selected from the drop down lists or entered manually in their respective boxes. They act in conjunction with the **Allow notes to** options (see below). Grid type can be straight, triplet, dotted or swing. If swing is selected, you will also need to specify swing strength.

Move left and **Move right**. If Quantize Position is enabled, these will ensure that notes are individually quantized to the start or end of the specified note fraction, whichever is nearest. Move left only will only quantize notes to the start, move right only will only quantize notes to the end.

Shrink and **Grow**. These are applied if Quantize Length is enabled. REAPER will extend or shorten notes by moving the end position of each note. You can enable either or both of these options.

The **Only quantize range** faders allow you to specify a percentage range for quantizing. 50% represents the mid-point between the grid lines. Values more than 50% are only really meaningful if "allow move right" or "allow move left" is disabled. The distance is measured from the grid line being quantized to: normally it will select the closest line so that you will never be more than 50% away.

Fix Overlaps can be enabled to stop notes from overlapping as a result of being quantized.

When the **Use Grid** Setting is selected, the Quantize Events dialog box will be as shown on the right.

From the **Grid** drop-down list (at the bottom of the MIDI

Editor window, next to the transport bar), select a note length value (such as 1/32, 1/16 or 1/8) and then select an item from the **grid spacing type** list. This can be straight, triplet, dotted or swing. If you choose **Swing** a

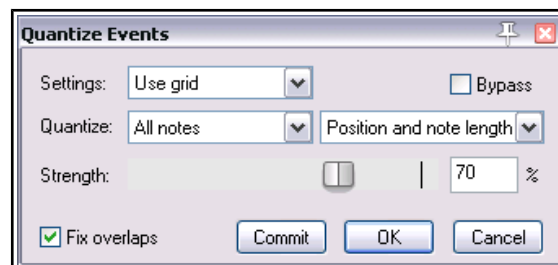

13 - Manipulating and Editing MIDI Items

strength fader is displayed (see below). This can be used to adjust the swing setting within a range of -100% to 100%, or you can enter a value directly into the **Swing %** edit box to its immediate right. You should also set a **Notes** value: left at Grid, this will take its value from whatever is chosen for the grid. Otherwise you may select any other required value from the drop down list.

Used well, swing can result in a more musically pleasing output.



In essence, you define a percentage delay to be applied on the upbeat. For example, if you apply swing to 1/4 notes then those which coincide with the 1/2 note divisions will be unaffected by the swing, those that fall between these divisions will be delayed by the amount specified. Small amounts of swing (even 5% or less) can help to prevent a part from sounding too rigid.

Quantize is non-destructive – that is to say, the process can be reversed at any time. The various other commands on the **Edit** menu that are used with quantizing are:

Quantize notes using last settings

This bypasses the **Quantize Events** dialog box, making it easier for you to apply the same quantization settings to various disparate selections.

Quantize notes position to grid

This quantizes notes according to your grid settings.

Unquantize events

Removes quantization and returns the notes to their previous state.

Freeze quantization for events

Freezes the quantization for all currently selected events.

Shown above is an example. The top picture shows two unquantized notes selected. In the second picture they are quantized by moving them left. In the third picture, they are quantized by moving them to the right.

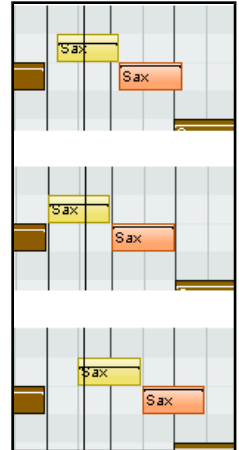

13.22 Input Quantization

The term **Input Quantize** refers to a process by which MIDI notes are automatically quantized as they are entered. This could be, for example, by playing your MIDI keyboard, or even the REAPER Virtual Keyboard.

Input quantize is applied on a per track basis. Simply right click over the track's VU Meter (TCP or MCP) and choose **Track Recording Settings** from the context menu. This causes the dialog box shown on the right to be displayed.

You should then select the option to **Quantize track MIDI recording**.

Options then available include:

- The note length to be used for quantization (e.g. 1/8).
- Your quantize positioning preference. Options are **Nearest value**, **Previous value** and **Next value**.
- Whether to quantize note-offs.
- Quantization strength. A lower setting will allow more subtle variation, creating a more "human" effect by allowing minor variations in how strictly the quantization is applied.

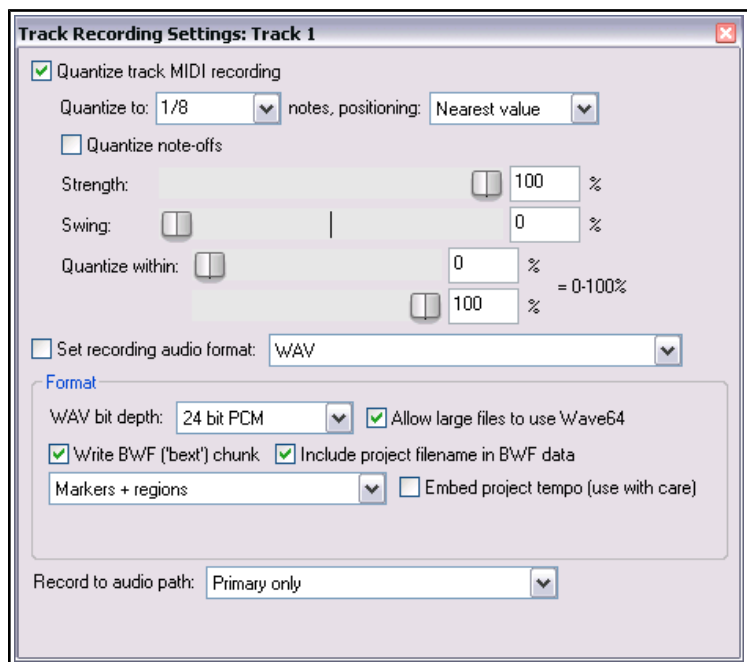

Up and Running: A REAPER User Guide v 5.24

- Swing setting. This can be between 0% and 100%. You can use this setting to add a touch of delay to those notes that do not fall on the upbeat. The best way to understand how these settings affect how your notes sound is to try a few examples.
- Quantize within % range. These are similar to the Nearly Quantized and Far From Quantized faders in the Quantize Events dialog box (see previous section).

13.23 Humanize Notes

Humanize Notes (from the Edit menu) can be used to introduce subtle variations – some might say imperfections! – to a MIDI item that is just too exact, too perfect. For example, no human pianist will ever complete an entire live performance on an acoustic piano with every key being struck with exact precision and perfect timing. Therefore, you might not want your MIDI items to be too perfect.

The **Humanize Notes** dialog box (right) can be used to introduced random variations in timing and velocity to an existing MIDI item to make it sound ... well, more human!

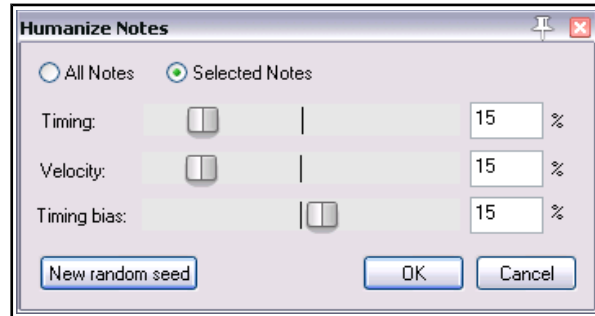

13.24 F3 - The Panic Button

The **F3** key can be your best friend when you are working in the MIDI Editor (and also when you are playing back MIDI items in REAPER's main Arrange View). Pressing F3 will set all notes to all MIDI outputs off, until you stop and recommence playback.

13.25 Using the MIDI Editor: a Basic Exercise

In this example, you will be introduced to some simple examples which involve working with the REAPER MIDI Editor. The objective of this is not to produce a stunningly brilliant piece of music, but to help you to become familiar with the MIDI Editor. The step by step instructions assume that you are using a PC with Windows. OS/X users will need to adapt some of the steps to suit their own environment.

Example

1. Create a new project file. Add one track to it. Arm this track for recording and set its input to your MIDI keyboard if you have one, or to the virtual keyboard if you do not.
2. Record about 20 or 30 seconds of a very simple tune on Channel 1. This might be part of a nursery rhyme or some other song with which you are familiar. Your Track and Item will look something like this:



3. If you are using Windows, display the track's routing window and add a MIDI Hardware Output to **Microsoft GS Wavetable SW Synth**.
4. Play the tune. It should play with a piano sound.
5. Double click on the item to open it with the MIDI Editor.
6. Check the first two MIDI toolbar buttons to make sure that neither the Track List nor Media Item Lane are displayed – you do not need them for this exercise,
7. Display the drop down note-length list (labeled Notes:) and set it to 1/2.
8. Scroll your mousewheel up or down until you are satisfied with the horizontal zoom setting. Use **Ctrl** with the mousewheel to find an acceptable vertical zoom setting. You should see something like this.

13 - Manipulating and Editing MIDI Items

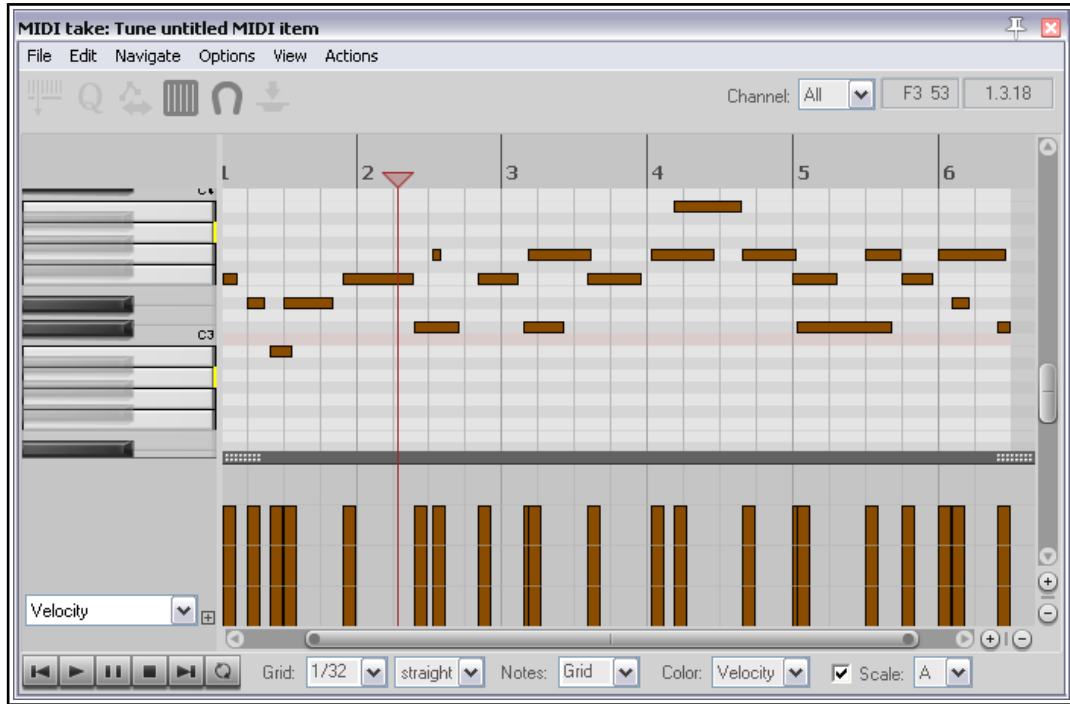

8. Just for fun, draw in a few more notes by clicking and dragging in the edit window. Experiment with using your mouse to move them about and change their length (by clicking and holding over a note's right edge and dragging left or right). Delete any that you do not want to keep.

9. Now Zoom out horizontally to see the entire length of the item.

10. Display the **CC Lane List** and choose **Bank/Program Select** (see right).

11. At the very start of the song, double click in the CC Lane. Select the bank **General MIDI** and the program **Church Organ**. Click on **OK**.

12. Return to the start of the timeline and play the tune. It should sound like a church organ.

13. Draw in a number of long "dronish" notes as shown below. Marquee them (right click drag) to select them all (but only your new notes).

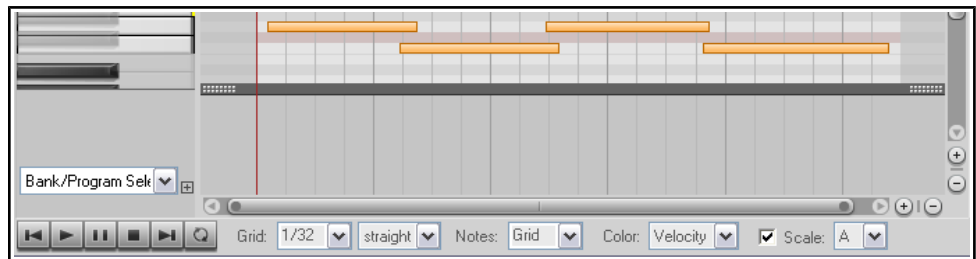

14. Right click over any of the selected items, choose **Note Channel** from the menu, then channel **2**.

15. Double click in the CC Lane, at the start of the song. Select **General MIDI**, **Choir Aahs** and **Channel 2** (see right). Click on **OK**.

16. Play the song from the start. You should hear an organ with a choir. The choir may seem too loud.

17. Change the CC lane to display **07 Volume MSB**.

18. Click on the Channel Filter List (on the toolbar) and choose Channel 2. Now only your Aaahs are displayed.

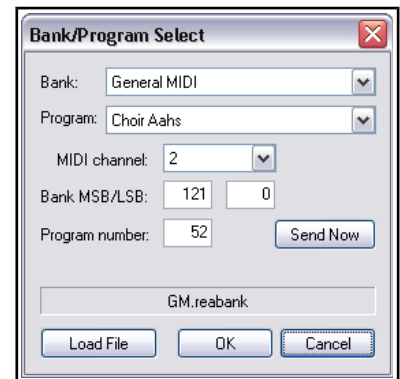

Up and Running: A REAPER User Guide v 5.24

- Click/hold/drag your mouse as you sweep along the CC Lane with a fairly low volume setting, as shown below.
- Remove the channel filter and restore all channels to view.
- Display the Color drop down list and choose Channel.
- Close the MIDI Editor and save the file.
- Play it. The choir should now sound a lot quieter.
- Continue if you wish to further explore the MIDI Editor on your own.

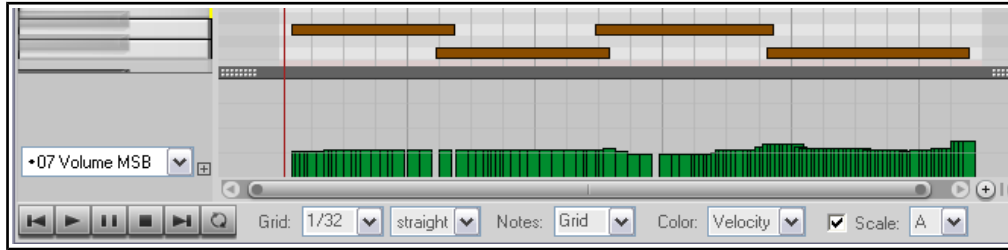

13.26 Step Recording

Step recording is a method of recording a sequence of MIDI notes within REAPER's MIDI Editor, one step at a time. In overview, you start by choosing a step size (such as a quarter or eighth note), then play your notes using a MIDI keyboard or the function keys F1 to F12. Each note you play is recorded and the insertion point is moved into position ready for the next note. You can then continue, playing more notes as you wish. You can also, if you wish, change the note size while recording. Let's see how this is done:

- From REAPER's main menu, choose **Insert, Virtual Instrument on new track**. Select the required instrument and click **OK**. The track should be inserted already armed for recording, with input monitoring enabled.
- Display the **Input** drop down list for this track and select a MIDI channel (or All channels) for your MIDI keyboard.
- Click and drag in the arrange area to define the length of your required MIDI item. From the menu, choose **Insert, New MIDI item** to insert the item.
- Open the item in the MIDI Editor. By default, double-click on item will do this, or you can choose **Open in built-in MIDI editor** from the right-click context menu.
- If you are using a keyboard, enable step recording either by choosing **Use all MIDI inputs for step recording** from the MIDI Editor Options menu, or by clicking on the equivalent toolbar button.
- If you wish to **Use F1 - F12 for step recording**, enable this menu option. These keys are then mapped to the 12 semitones of an octave. In this example, we'll use these keys. Remember, however, you could use a MIDI keyboard if you have one.
- Select a note length (e.g. 1/4, 1/8) from the drop down list next to the MIDI Editor's transport bar.
- In the piano roll keyboard, select a note (e.g. C4). This note will now be represented by F1, with subsequent function keys moving up the scale to higher notes. Press function keys as required to enter notes and to advance the cursor according to snap settings (hold Shift if you wish for snap settings to be ignored). These notes can be edited like any others, for example to adjust velocity.
- Selecting a different note in the MIDI editor keyboard will reset the value of F1 (and all other function keys accordingly).

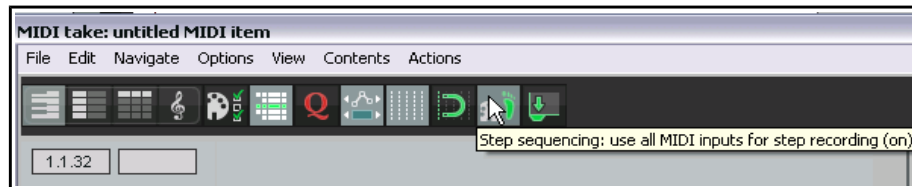

These instructions represent the essentials of step recording. Depending on which virtual instrument you use, and on your MIDI keyboard setup, you might need to "tweak" them to suit your exact requirements.

13.27 Working with Multiple MIDI Tracks and/or Items (Overview)

From Arrange view you can make MIDI items available for editing by choosing the command **Open in built-in MIDI editor** from the right click context menu. This command has four mutually exclusive options – **Open clicked MIDI item only**, **Open all selected MIDI items**, **Open all MIDI on same track**, and **Open all MIDI in project**. You can set a default option in the **Editing Behavior, MIDI Editor** page of REAPER's preferences (see Chapter 22).

Double-clicking on the item causes the MIDI Editor to open according to your preferences setting. For example, if you set your preference to one MIDI editor per media item, then each MIDI item you double-click on will open in a separate MIDI editor instance by itself. If you set it to one MIDI editor per project, this will result in all MIDI items being opened in the MIDI editor when any single MIDI item is double-clicked: The double-clicked item will be the selected and active item.

If **One MIDI editor per project** is specified, then you should also specify whether to open the clicked MIDI item only, all selected MIDI items, all MIDI items on the same track, or all MIDI items in the project (see right).

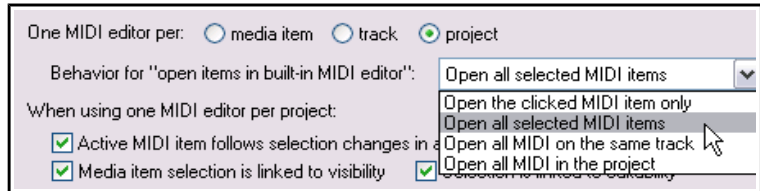

Within the MIDI Editor, your default preference settings can be overridden on a per project basis from the **Contents** menu. This will be discussed shortly.

Tracks and items can be managed in the MIDI Editor by displaying the **Media Item Lane** (second button on toolbar toggles) and the **Track List** (first button on toolbar toggles). Both these options are also available on the **Contents** menu.

The illustration below shows an example of the MIDI Editor window opened with three MIDI tracks, the first of which comprises three items. Both the Track List (right of window) and the Media Item Pane (foot of window) are displayed. In a moment, we'll examine these more closely.

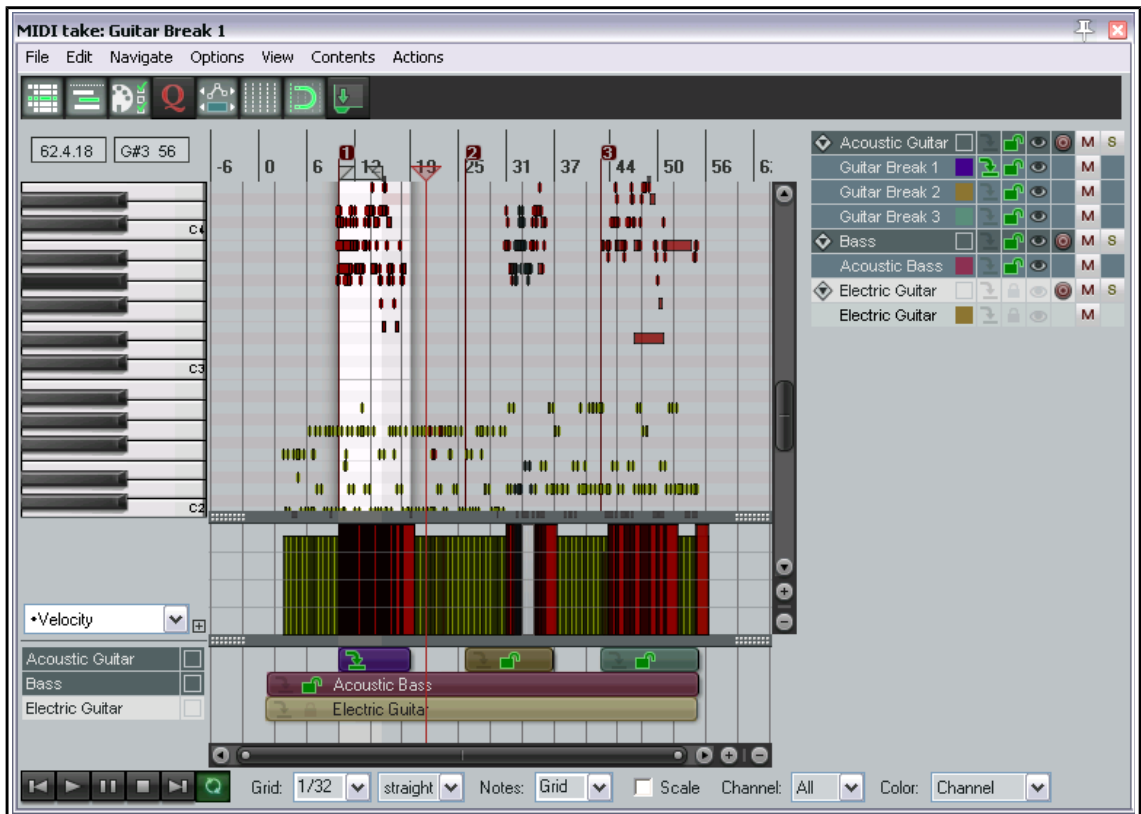

In the MIDI Editor each item is assigned three qualities – visibility status, active status and editability status. These can be set as required to allow you to work with different items at different times. **Visible** means the item and its notes are displayed in the MIDI editor window. **Active** means that the item can be used for inserting, copying, pasting notes, etc. **Editable** means that mouse edits (move, lengthen, etc.) and commands such as quantize, transpose and humanize can be performed on an item's notes. One and only one item at a time may be active, but as many items as you wish may at any time be visible and/or editable. Note that:

- ◆ An item can be visible without having to be editable or active. One or more items may be visible.
- ◆ An editable item will also be visible but need not be active. One or more items may be editable.
- ◆ An active item will also be editable and visible. One and only one item is active at any time.



An item can be made active using the track list (above right). A track can be made active from the **Contents** menu or using the drop down list near the end of the transport bar (also see below right). If the track contains only one MIDI item, that item will be made active. If it contains more than one item, all items will be visible and editable but only one item will be active.

The **Filter Events** window allows you to select multiple channels for display and editing. If you select two or more channels in this window, the drop down channel list at the foot of the MIDI editor window will read "Multi" or "All". Alternately, you can simply use the drop down channel list to select "All."

The **MIDI** column in the **Track Manager** (Chapter 12) can also be used to open items in/remove items from the MIDI Editor, and to show items in/hide items from the MIDI Editor track list. Tracks can also be selected to be shown in or hidden from the track list using the track list's context menu (see below).

13.28 Managing Multiple MIDI Tracks and Items

The Track List

Track List display is toggled on and off by the first icon on the MIDI Editor toolbar, or from the **Contents** menu. Right-click on the track list area to open the Track List context menu. If you need to override the preferences default setting, you can specify whether you want **One MIDI editor per media item, track, or project.**

Behavior for "open items in built-in MIDI editor" options are to open **Clicked item only**, **All selected MIDI items**, **All MIDI items on same track as clicked item** or **All MIDI in project**. These options are also available from the MIDI editor Contents menu.

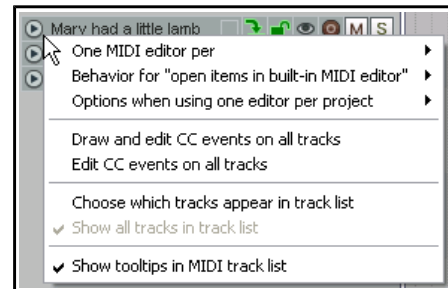

Two mutually exclusive options from the MIDI Editor **Options** menu are repeated here: these are **Draw and edit CC events on all tracks** and **Edit CC events on all tracks**. You can enable neither or one of these at a time, but not both.

You can use the command **Choose which tracks appear in track list** to hide tracks from or restore them to the track list. Selecting this command causes the **X** symbol to be displayed beside each track name. This toggles track display. In its default gray state, the track will be marked for display, when red it will be marked to be hidden. After making your selection, again select **Choose which tracks appear in track list** from the context menu to implement this selection. Those tracks marked with a red **X** will now be hidden. The command **Show all tracks in track list** will restore them to view. Also, you can choose whether to **Show tooltips in MIDI track list.**



The **Options when using one MIDI editor per project** command (also on the MIDI editor **Contents** menu) includes further ways in which you can specify MIDI Editor behavior when selecting and editing items

- ◆ Item selection toggle options are **Active MIDI item follows selection changes in arrange view**, **Media item selection is linked to visibility** and **Media item selection is linked to**

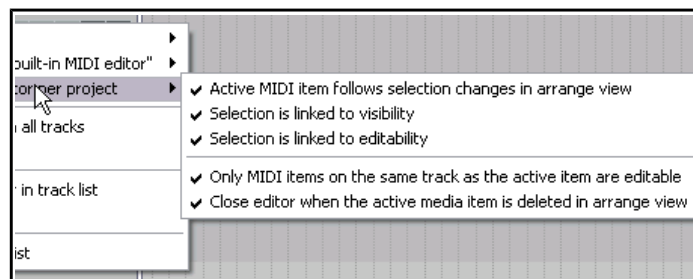

13 - Manipulating and Editing MIDI Items

editability. Select any, all or none of these.

- ◆ Item editing toggle options are **Only MIDI items on the same track as the active item are editable** and **Close editor when active MIDI item is deleted in arrange view**. Enable both or neither of these.

In the example shown here three tracks are displayed, containing in total five MIDI items. The Acoustic Guitar track holds three items. Guitar break 1 is the active item: it is therefore also editable and visible. guitar break 2 is editable and visible, guitar break 3 is visible but not editable. The acoustic bass item is both editable and visible. The electric guitar is not visible and therefore not editable.



The diamond shaped symbol to the left of each track name opens and closes a list of MIDI items on that track.

The track list here operates in much the same way as does the arrange view track list. Click on any item name to select it, or on any track name to select all items on a track. You can use control+click or shift+click to build a selection. The first item in a built selection will be made active, but you can change this by clicking on the "make active" icon of any other item. You can then use the various other icons to set qualities such

as icon color, solo, mute or editability for the entire selection.

The small colored square to the right of an item name opens the color picker: this can be used to select a different color to be used for this item in the Media Item Lane.

The column to the right of the color picker is the "make active" column. Click here to make any item the current item for inserting events (shown by the green arrow). It will automatically also be made editable and visible.

Click in the next column to the right of this to make any item visible and editable, indicated by the green unlocked padlock icon. If contents do not appear visible, check 1) the scroll settings for the MIDI editor window, and 2) the channel filter, to ensure that the required channel is included in the filter. This same green icon can then be used to toggle editability.

The eye symbol to the right of this toggles the visibility of any item (or item selection) in the MIDI Editor. The gray/red circle to the right of this (for tracks) toggles record arm status for that track. This is used in conjunction with the Record button on the Arrange view Transport Bar.

Use the **M** button to the right of this to toggle mute status for individual tracks or items. Use the **S** button to the right of this to toggle solo status for any track.

The track list can also be opened (shown) and hidden using the track select drop down list at the bottom of the MIDI Editor window.

The Media Item Lane

This displays the MIDI items and their position in the arrangement. Clicking on any item highlights, selects it but does not make it active. As with the track list, you can use control+click or shift+click to build a selection.



The individual media item right-click context menu offers you various options for setting items to custom colors or random colors.

13.29 Editing Multiple MIDI Items

In order to be able to edit different MIDI items at the same time you will first need to select those items that you wish to make available for editing, as explained in the previous section. You can then perform normal mouse editing activities on any part of the selection, such as copying or moving, adjusting velocity, stretching, shrinking, etc. The table below gives some examples of how you can apply this to various MIDI editing tasks.

If you want to do this do this!
Change track/item name.	Double-click on name in track list and edit.
Copy/move a note (or note selection) to another item within MIDI editor.	Make sure source item(s) editable. Select note(s), press Ctrl C (copy) or Ctrl X (cut). Make the destination item active. If required, position play cursor. Press Ctrl V (paste).

If you want to do this do this!
Copy/move a note (or note selection) to another item in Arrange view.	Make source item(s) editable in MIDI Editor. Select note(s), press Ctrl C (copy) or Ctrl X (cut). Select destination item in Arrange view, make it active in MIDI Editor, position play cursor. Press Ctrl V (paste).
Mouse edit a selection of notes in more than one MIDI item.	Make items editable. Select notes and use mouse (e.g. drag to move, click drag from edge of any note to lengthen or shorten notes).
Delete selection of notes across more than one item.	Make items editable. Select notes and press Delete key.
Mute/Unmute note selection across more than one item.	Make items editable. Select notes and press Alt M , or use Mute events command from Edit menu.
Change note properties for a selection of notes	Make items editable. Select notes and press Ctrl F2 . Make changes then OK .
Quantize, Humanize, Transpose across multiple items.	Make all required items editable. Make note selection and choose Edit menu command, e.g. Quantize, Humanize, Transpose.
Adjust velocity of notes selected in two or more items.	Display velocity lane and make items editable. Select required notes. Click/drag mouse up/down from top edge to increase/decrease velocity.
Edit CC data across multiple MIDI items.	Display CC lane and make items editable. Select required events and perform edit as required with mouse or via Event Properties dialog.
Show/Hide all MIDI items on tracks in Track List.	Click (for one track) or Shift click (for all tracks) on diamond symbol to the left of any track name in Track List (toggle).
Show/Hide all tracks/MIDI items in Track Folder.	Click on circle symbol to left of folder name in Track List (toggle).

MIDI Editing with Multiple Items: Some Tips and Examples

These notes assume that you are by now familiar with the basic MIDI editor navigation and editing techniques explained earlier in this chapter and, for example, shown in the exercise in section 12.24. Indeed, you are advised not to experiment with editing multiple MIDI items until you are confident that you have mastered the techniques for editing the contents of a single MIDI item.

13.30 MIDI Editor Mouse Modifiers

The Mouse Modifier dialog is opened by the **Options, MIDI editor mouse modifiers** command. Here you can customize exactly how you would like the mouse to behave when you are working in the MIDI editor.

There are several areas in which you can modify mouse behavior within the MIDI Editor. These include **MIDI note**, **MIDI note edge**, **MIDI CC lane**, **MIDI CC event**, **MIDI Source loop and marker**, **MIDI ruler**, **MIDI marker/ region lanes**, **MIDI piano roll** and **MIDI editor**. In many cases, separate contexts are available for left click, left drag and double-click behaviors. For example, if you wanted to, you could ensure that, say, **Shift Alt Left click** is used to toggle a note's mute status.

For much more about mouse modifiers, including MIDI Editor mouse modifiers, see Chapter 15.

13.31 MIDI Editor Actions

REAPER's Action list Editor lets you assign keyboard shortcuts to any command or action, or sequence of actions, including many not shown on the MIDI Editor menus. Chapter 15 will show you how to do this, including adding actions to the MIDI Editor menus.

The Action list is displayed by choosing **Show actions list** from the **Actions** menu. One of the first things to notice about it is that it contains a whole load of assignable actions beyond those that are shown on REAPER's menus. This means that you are able to create your own keyboard shortcuts for any of these actions, and even for sequences of actions.

Notice also (right) that when using the MIDI Editor Action List, you are able to assign MIDI commands and actions to keystrokes so that those keys will behave differently in the MIDI Editor from the way they behave in

13 - Manipulating and Editing MIDI Items

the main REAPER environment. You can see that there's quite a few, and that some already have keys assigned to them. You can assign your own keys to other actions.

Let's take a simple example. Being able to select notes quickly and easily is important when you are working with the MIDI editor. If in the Action List filter box you type **add note** then only those actions which included these characters will be displayed (see right). One of these is **Add next note to selection**. You can assign a shortcut to this action – perhaps the letter N.

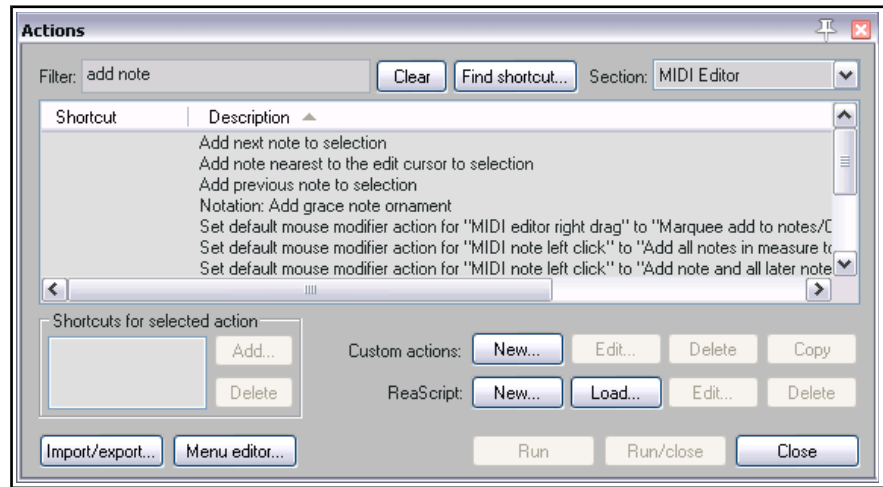

Example

1. With any MIDI item open in the MIDI Editor, choose the **Actions, Show actions list** command.
2. Click on the action **Add next note to selection**.
3. Click on the **Add...** button. This causes the **Keyboard or MIDI Input** window to be displayed.
4. Press the letter **N**. Click on **OK**. You can see that this keystroke has now been assigned to this action.
5. **Close** the Actions List.
6. Click on any note to select it. Now press **N** several times. Each time you do so, the selection will be extended by one note. You could now move these notes together, or assign them to a different channel, or delete them, or perform any other editing action.

You'll see in Chapter 15 that the Actions List Editor lets you do much more than this. For example, you can:

- Chain together any sequence of actions so that the sequence can be executed with a single keystroke.
- Add actions and custom actions to your MIDI Editor toolbar and/or the MIDI editor Actions menu, and/or any of REAPER's MIDI Editor menu commands (File, Edit, Navigate, Options, etc.)
- REAPER's MIDI Editor commands (such as Edit -> Delete events, Edit -> Insert note, Edit -> Quantize, Navigate -> Select next note, Options -> Correct overlapping notes when editing, etc.) can all be found in the Action list. In addition there are many hundreds of actions, some very precise, which are not shown on the menus. The table that follows should help guide you thru many of these.

Category/Group	Examples of MIDI Editor assignable actions(not fully comprehensive)
Note/event selection	Select all notes with same note value, Select note nearest to edit cursor, Select all muted notes. Add next/previous note to selection, Add note nearest edit cursor to selection. Select/unselect all CC events, Select/unselect all CC events in last clicked lane. Select all notes in time selection, Select all notes starting in time selection, Select all CC events in time selection (several variations).
Activate item/track	Activate next/next visible/previous/previous visible MIDI item. Activate next/next visible/previous/previous visible MIDI track (if multiple items/tracks are open).
CC lane management	Next/previous CC lane. Set CC lane to xxx.
Channel display	Show only channel xx, Show only next/previous channel, Toggle channel xx, Color notes/CC by channel.
Grid actions	Set grid type (straight, dotted, triplet, swing). Adjust swing grid strength (CC/mousewheel).

Up and Running: A REAPER User Guide v 5.24

Category/Group	Examples of MIDI Editor assignable actions(not fully comprehensive)
Note inserting/ editing/ manipulating/ moving/ transposing	Color notes by velocity/channel/media item custom color/using colormap/by track custom color. Delete all notes/trailing notes less than [1/128 to 1/8] note in length. Lengthen/shorten one grid unit/one pixel. Make notes legato, preserving note start times/relative note spacing. Move notes down/up one octave/semitone (transpose) Move notes left/right one grid unit/one pixel. Invert selected/all notes. Reverse selected/all notes. Invert chord voicings. Edit note velocity +/- 01/10. Set note length to grid size/double/half. Trim left/right edge of notes to edit cursor. Insert note [1/128 to 1] note length. Set note length to [1/128 to 1] Set note ends to start of next note. Set note position to edit cursor. Split notes on grid. Copy/cut/duplicate notes within time selection, Fit notes to time selection. Paste events into active media item regardless of source media item (<i>allows items to be copied from a selection of media items into a single media item.</i>)
Loop/time selection	Loop point: set start/end point. Remove loop point. Double/halve loop length. Set time selection to selected notes, Remove time selection, Remove time and loop point selection. Move cursor to start/end of loop/time selection.
Cursor movement	Cursor advance [1/128 to 1]. Cursor advance [1/32T to 1/4T].
Lyric events	Align lyric events with notes. Import lyrics for selected notes from file. Insert/edit text/lyric event at first selected note. Select next/previous lyric event. Shift lyric events backward/forward one note.
Mouse modifiers	Actions are available to set mouse modifier behavior within the MIDI Editor for each of the categories CC event left drag, CC lane left drag, MIDI editor right drag, note edge left drag, note left click, note left drag, piano roll left click, piano roll left drag, ruler left click and ruler left drag. The list of actions is exhaustive.

13.32 In-Line MIDI Editing

To use the in-line editor on any MIDI item, first select the item then either use the default shortcut key **E** or right click and from the menu choose **Open items in Editor** then **Open items in In-line Editor**. The in-line editor will only be displayed if there is sufficient track height.

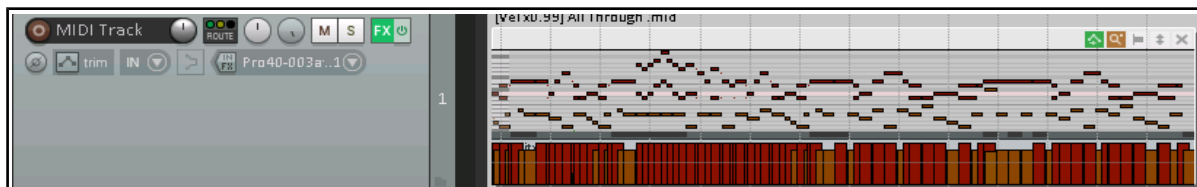

REAPER's main MIDI Editor is recommended for serious and in-depth editing of your MIDI items. However, many common tasks can be carried out using the in-line editor if you prefer. This allows you to edit the MIDI item without leaving the main window.

The in-line editor displays piano roll view only, and the contents of CC lanes will be determined by whichever lanes were selected last time the item was opened in the MIDI Editor. If it has never been opened in the MIDI

13 - Manipulating and Editing MIDI Items

Editor, the Velocity lane will be selected by default. You can adjust the boundary between the editing area and the CC lane with the mouse to adjust its height, just as in the MIDI Editor.

Right-clicking over the editing area will display a menu that will show you which editing tasks can be carried out with the in-line editor. These are listed in detail in Chapter 22, but in summary, the following types of commands and actions are supported within the in-line MIDI editor:

- Note editing mouse actions, including change length, change velocity, marquee, move, delete and insert.
- Most commands on the MIDI Editor's Edit and View menus, including quantize and humanize.

When working with the in-line editor, any keyboard shortcuts and custom actions that you have defined in the main MIDI Editor will apply, along with any defaults. For example, **PageUp** and **PageDown** will zoom vertically in and out within the in-line editor. You can run your MIDI Editor custom actions within the in-line editor. The in-line editor also displays a small toolbar in its top right corner. From left to right, the function of these tools is:

- The **Move CC with events** toggle tool: serves the same purpose as its equivalent tool in the MIDI Editor window.
- The **Show/Hide** tool (magnifying glass): toggles between the functions Show all note rows, Hide unused note rows and Hide unused and unnamed note rows.
- The **Item Style** tool: toggles between rectangle, triangle and diamond note display style.
- The **Vertical Scroll/Zoom** tool. Click and hold on this and drag vertically up or down to scroll vertically up and down, left and right to zoom vertically in and out (see example, right). You can double-click on this button to zoom to contents.
- The **X** tool. This closes the in-line editor and restores normal display.

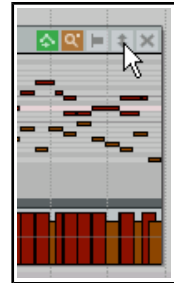

The MIDI Editor and In-line Editor are designed for editing your MIDI *events*. Remember also that many of the *item* editing tasks, functions and activities that you discovered in Chapter 7 can also be applied to MIDI *items* as a whole. For example, in arrange view items can be dragged and dropped, split, copied, muted, grouped in selection sets, locked and so on. Plug-ins can be added directly to an item's FX chain. Selecting a MIDI item in Arrange view and pressing **F2** will display its Item Properties window where you can shift pitch, change play rate, loop enable/disable, and do much more.

13.33 Copying MIDI Items in Arrange View

When you make a copy of a MIDI item in arrange view, then depending on your preferences and on how you make the copy one of two outcomes will occur:

The first of these is that the new item will be created as a new instance of the original item, and will use the same source data as the original. In this case, any changes made to either item will be applied to the source data, and therefore also to the other item. This might be what you want, for example, if you have a melody, a

bass line, or a drum pattern that you wish to repeat throughout a project. You're still working on the line, and you may need at some future time to make changes to these items, and you wish to do this in such a way that when you make these changes to any one item they will automatically be applied to all of the others.

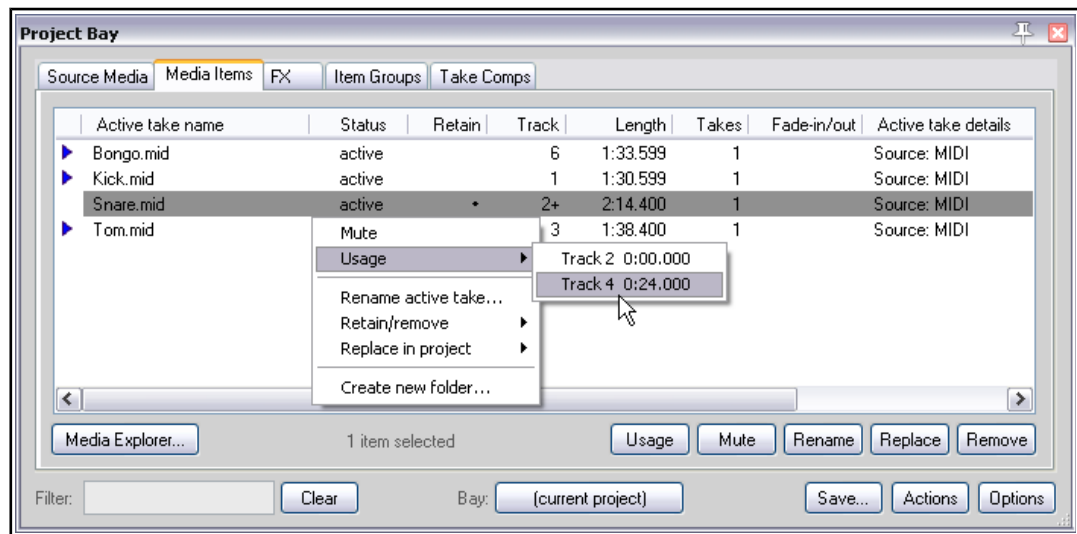

Up and Running: A REAPER User Guide v 5.24

In the alternative scenario, the new MIDI item becomes a discrete item in its own right, so that you can independently edit either item without affecting the other.

By default, when you copy and paste items using the menus or keyboard shortcuts (such as **Ctrl Shift C** and **Ctrl V**), the former method (with common source data) is applied. The items are also added to the Project Media Bay (see Chapter 12) where they are listed as MIDI pool items.

To change this default behavior, disable the preference (under **Options, Preferences, Media, MIDI**) to **Pool MIDI source data when pasting or duplicating media items** (see also Chapter 22). Items will then by default be copied as discrete items. Note that a new MIDI pool item is never created when an existing MIDI item is split. Note also that by default MIDI items added to a project from the Project Media Bay are not pooled.

The default behavior when you copy an item by dragging with the mouse depends on your mouse modifier settings for the context **Media item drag**. By default, the following apply when dragging MIDI items:

- | | |
|--|--------------------------------------|
| Drag and drop | Move item ignoring time selection |
| Ctrl with drag and drop | Copy item as discrete item |
| Shift Ctrl Alt with drag and drop | Copy item, pooling MIDI source data. |

For a complete list of mouse modifiers, see the Editing Behavior, Mouse Modifiers page of your Preferences. Select **Media item left drag** from the context list. You can change any assignments if you wish. The method is explained in Chapter 15.



You can remove any individual MIDI item's pooled status and convert it into a discrete item. To do this, either display the item's source properties window (**Ctrl F2** or use the context menu) and click on **Un-pool this item**, or click on the item's pooled status icon (see above).

13.34 Joining MIDI Items

There may be times when you wish to join a number of MIDI items together. This might, for example, be to create a single loop enabled item, or simply so that you can edit them as one item, or perhaps to be able to export the MIDI data as a single MIDI file. For example, you might have several MIDI items that you wish to export together as a single file. The track shown below might be an example of this.

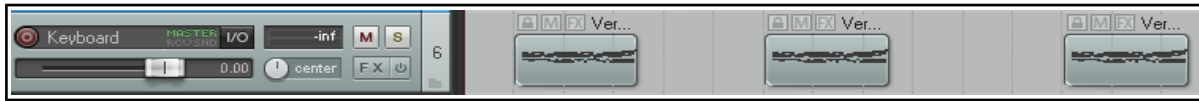

You can select all of the items (right-click and drag is often the easiest way to do this) and glue them together: right-click anywhere on the selection and choose **Glue items** from the context menu.



You can then double-click on the glued item to open the MIDI Editor, from where you can export it as a single MIDI file (**File, Export to new MIDI file ...**).

13.35 MIDI Preferences Settings

To specify your MIDI preferences, choose the **Options, Preferences** command (**Ctrl P**) and then select the **Media, MIDI** page. You'll find these shown in Chapter 22, but for now the following are worth noting.

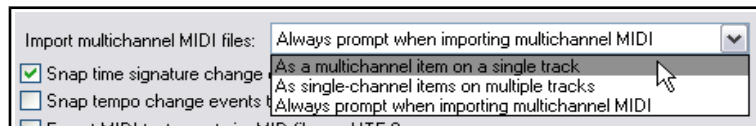

- ◆ You can specify whether by default new MIDI items are created as REAPER media items (the default) or .MID files.
- ◆ You can specify how your edits to imported .MID files are to be interpreted – that is, whether to apply your edits only to the item in the REAPER project file or also to the original file on your disk.
- ◆ You can set the default behavior for imported multichannel MIDI files – as multichannel on a single track, as single-channel items on multiple tracks, or always prompt to ask.

13.36 MIDI Output Direct to an External Synth

The MIDI output of any track or selection of track can be sent directly to an external hardware synthesizer instead of (or as well as) to the master. Right-click on the track's ROUTE button, choose MIDI output from the menu, then the device name, then the channels. Optionally, you may also disable output to the master send.

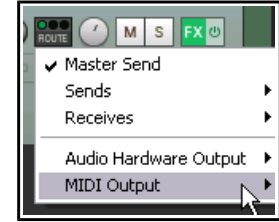

13.37 Exporting Project MIDI

From Arrange view, the **File, Export Project MIDI ...**

command can be used to export either an entire MIDI project or selected items or tracks within that project to a single MIDI file.

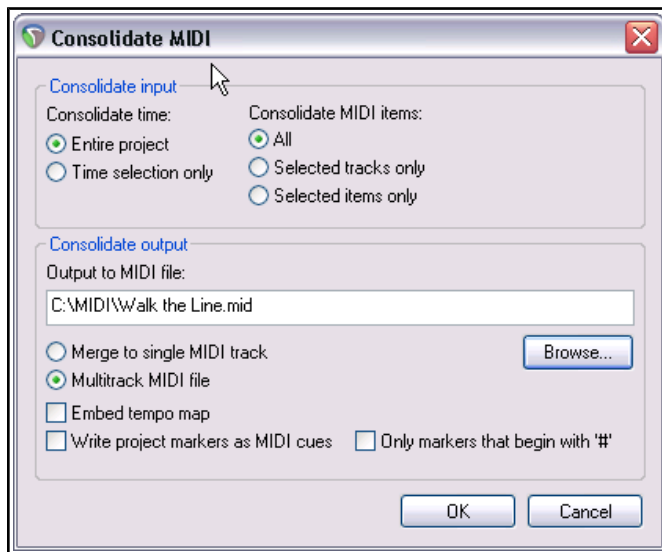

An example of such a project file is shown here. It includes six tracks with MIDI events (a different channel for each track), enclosed in a folder whose FX chain includes a virtual instrument. For the most part, the options shown here require little explanation.

You can choose to export the **Entire project** time or the current **Time selection only**.

You can include **All** media items within the project, or **Selected tracks only** or **Selected items only**. In the example shown, **All** MIDI items has been chosen.

You can merge the various MIDI tracks to a **single MIDI track** in the output file or export it as a **Multitrack MIDI file**, with the integrity of the different tracks maintained in the output file.

You also have options to **Embed tempo map** and/or **Write project markers as MIDI cues**.

13.38 Feedback Routing with MIDI Tracks

We have already mentioned (Chapter 2) that REAPER's project settings allow you to use feedback routing. You will need to enable this feature if you wish to route MIDI output from one track to another, then audio output from the second track back to the first.

13.39 MIDI Routing, MIDI Buses and ReWire

REAPER's MIDI routing capabilities can be enhanced by the use of MIDI buses. By default, your MIDI tracks can contain up to 16 MIDI buses, each comprising 16 MIDI channels. When sending MIDI data from one track to another, you are able to specify bus/channel combinations for both the source and destination tracks rather than just a channel.

These options are available in the drop down lists in the MIDI send/receive windows (below right).

MIDI data sent from one track to another in this way can be directly routed to any VST or AU synth in that track's FX chain. To do this, right-click over the plug-in's "2 Out" button and choose the required MIDI Bus from the MIDI Input menu (right).

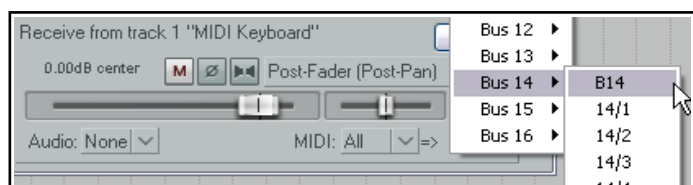

Up and Running: A REAPER User Guide v 5.24

The same context menu can also be used to assign MIDI Output to any bus, and/or to assign the synth's audio output to any track channel or channels.

When a track has volume and pan MIDI controls, moving the volume/pan fader within the routing window will generate CC7/CC10 events. When a send's MIDI routing button is enabled, these CC events are sent to the destination track.

ReWire users may be interested to know that MIDI data routed in this way can be also be mapped to ReWire, using any permutation of buses/channels that you require. For more information about using ReWire with REAPER, see Chapter 17.

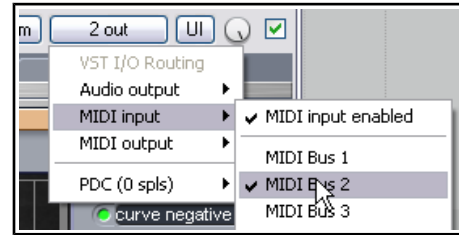

13.40 ReaControlMIDI

The Cockos ReaControlMIDI plug-in can be used with any MIDI track to set various MIDI parameters on that track. It can be inserted from the track's FX chain, or by right-clicking over the track name or number and choosing **Show ReaControlMIDI for Selected Tracks** from the menu.

You can use several different instances of this plug-in on the one track to send different MIDI messages to different channels. This enables you, for example, to send control messages to a synth or virtual instrument placed after ReaControlMIDI in the FX chain.

Many DAWs have MIDI tracks with MIDI-specific controls, like bank/program select, MIDI volume and pan, etc. REAPER instead uses ReaControlMIDI, which provides a MIDI track TCP for any track.

This gives you additional flexibility, because you can insert multiple instances, or insert it at any point in an FX chain, either for the track as a whole or for individual items. Notable features of ReaControlMIDI include:

Load File: You can load a REAPER .reabank file or Cakewalk .ins file of instrument definitions and then select a preferred bank/program combination.

Control Change: Up to five CC items can be selected from the drop down lists. Any and all of the items available for CC lanes in the MIDI Editor are available. ReaControlMIDI also gives you a vehicle for creating MIDI CC track envelopes, by allowing automation of any of the plug-in's enabled CC sliders. Automation will be explained in Chapters 17 and 18.

You can also assign track controls to the TCP and/or MCP to manage its various parameters. This is explained in Chapter 12.

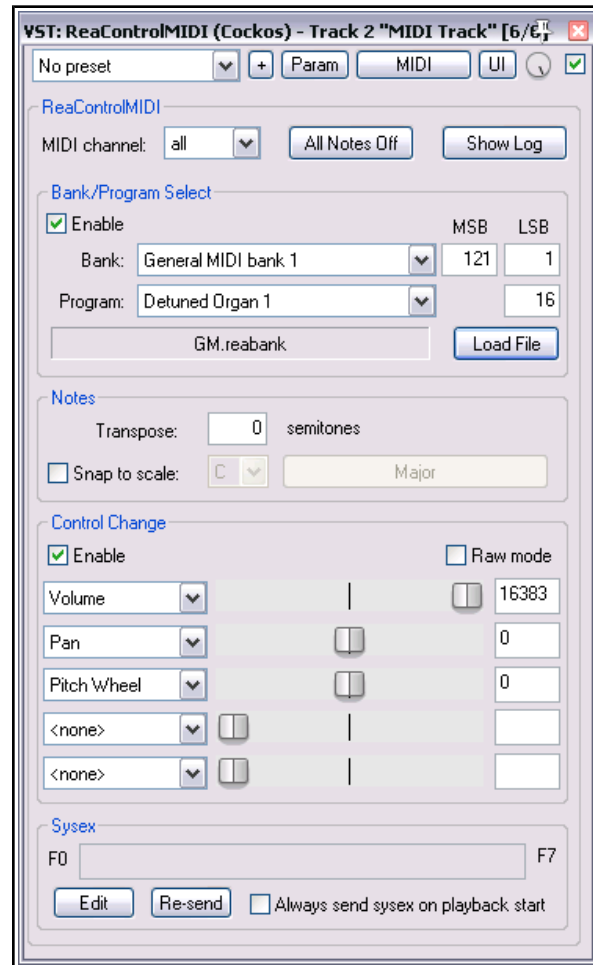

13.41 Some MIDI Plug-ins

REAPER includes a good selection of plug-ins that can be placed into the FX chain of any of your MIDI tracks, or directly into any MIDI item. Many of these have been written and developed by Philip Consadine. Now is a good time to take a look at them.

The basic steps involved in inserting and using Track FX are covered in the section Track FX Basics. If you are unfamiliar with these steps, you should review that section before proceeding.

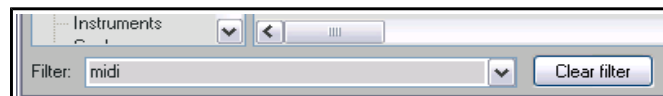

If you display the **Add FX** window and type *midi* into the filter list box (as shown here), you will see a list of those MIDI FX that are currently available. Below are listed some of the JS MIDI FX supplied with REAPER.

13 - Manipulating and Editing MIDI Items

FX Name	Comments
MIDI_CCRider	A LFO Controlled CC generator.
MIDI_DuplicateFilter	Blocks duplicate notes.
MIDI_KeyMap	A MIDI key mapping utility.
MIDI_KeySnap	This is a good cheat for bad pianists.
MIDI_Router	Routes events from one channel to another.
MIDI_Tool and MIDI Tool II	These do interesting and fun things to MIDI note events.
midi_transpose	Transposes a note or a range of note.
MIDI_Variant	A pattern based, musically aware, randomification monster.
MIDI_Velocifier II	This is a pattern based velocity modifier.
midi_velocitycontrol	Used to vary and control velocity on a MIDI track.
MIDI_Wobulator	A LFO Controlled automatic pitch wobulator.
sequencer_megababy	An awesome pattern sequencer (see later in this chapter).
Synthesis/midi_drumseq	Use this drum sequencer with your favourite patch set.

These plug-ins can be made even more powerful by the use of automation envelopes, which can be applied to any of their parameters. How to create, manage and apply automation envelopes will be covered in Chapter 18.

For more information about how to use these and other MIDI plug-ins, visit the Cockos web site, and in particular http://www.cockos.com/wiki/index.php/Jesasonic_Effects_Documentation#MIDI

13.42 MIDI Controlled Pitch Shift with ReaVoice

The **ReaVoice** plug-in can be used in conjunction with a recorded vocal track to create pitch shift harmonies. As with many other plug-ins, **ReaVoice** can be used in a number of ways. In this section we will take you thru just one example. After completing this example you should be able to experiment with this plug-in's capabilities for yourself. The procedure for using ReaVoice is as follows:

- Record the Vocal Track.
- Insert a new track immediately below the Vocal Track.
- Create a send from the Vocal Track to the new track. Initially at least, this should be Pre FX.
- Insert ReaVoice into the FX Window of the new track.
- Arm this track for recording. Make your MIDI keyboard the Input Device and turn Input Monitoring on.
- Mute all tracks except these two.
- Play the song. As you do so, play the keyboard, experimenting until you find an appropriate range of notes.
- Work out what you want to play, press **W** to return to the beginning, then **Ctrl R** to record. Stop recording when finished.
- If you do not have a MIDI keyboard, you can either use REAPER's Virtual keyboard, or you can enter the notes by hand using the MIDI Editor.

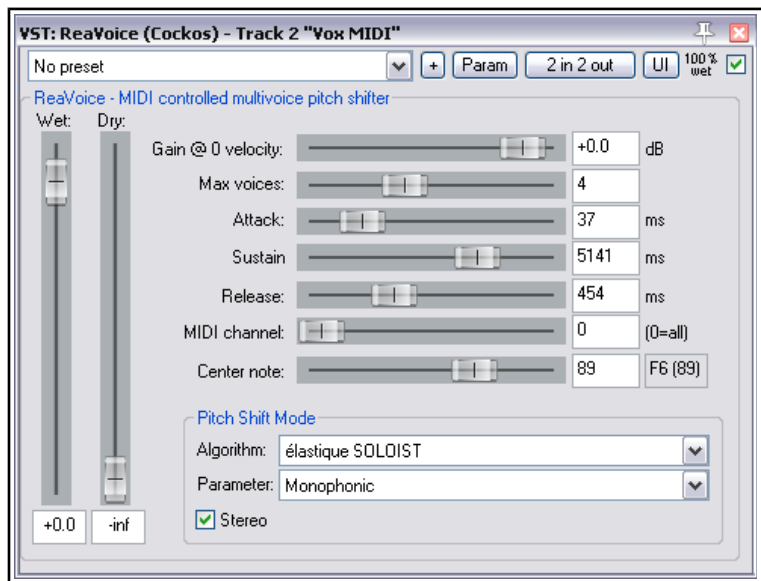

Up and Running: A REAPER User Guide v 5.24

- If you wish, you can record more than one take, selecting **Play All Takes** for the MIDI track items.
- After finishing recording, you can use the MIDI Editor to polish your work.

Example

In this example, you'll have some fun and explore how ReaVoice works at the same time.

1. Open the file **All Through The Night.rpp** and save it as **All Through The Night REAVOICE.rpp**.
2. Mute all tracks except the Vox track.
3. Move the Vox track to the top, select it and press **Ctrl T** to insert a new track. Your Vox track is now track 1 and the new track is track 2.
4. Name the new track **Vox MIDI**.
5. Display the **Routing** window for the **Vox MIDI** track and add a new **Pre FX Receive** on **Audio 1/2** from the Vox track.
6. Insert the **ReaVoice** plug-in into the FX Window for this track. For now make its settings as shown above. Note in particular the number of voices and the long sustain setting.
7. In the **Vox MIDI** track, insert an empty MIDI item from about the 13 sec mark to about the 50 sec mark. This should coincide with the first vocal passage on the Vox track.
8. Double click on this to open it in the MIDI Editor.
9. Create a pattern of notes similar to that shown above. You don't need to follow this precise pattern, be prepared to experiment.
10. As you play the song, make sure that the two vocal tracks are soloed. You can of course edit any individual note or notes, for example, by moving them up or down, by lengthening them or shortening them, or by changing their pitch. Here are some more possibilities, just for fun and to give you some ideas.
11. Within the MIDI Editor window, press **Ctrl A** to select all events.
12. Press **Ctrl F2** to display the **Note Properties** dialog box.
13. In the **Note** box, type **+2** (as shown) then click on **OK**. This raises the entire selection by two semitones.
14. Experiment with other settings as you wish. Save the file finished.
15. Now experiment with adjusting some of the ReaVoice settings.

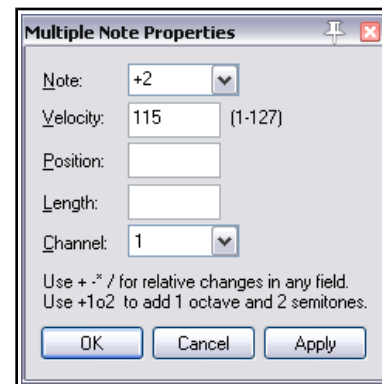
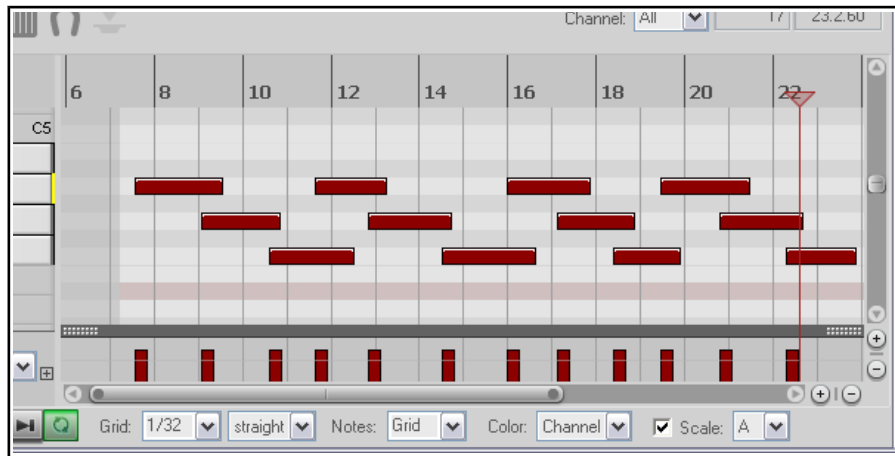

13.43 JS: IX/MIDI_Router

This plug-in can be inserted from a track's FX chain. It is used to redirect MIDI data from one channel to another.

You can choose whether to send notes, non-notes, or both.

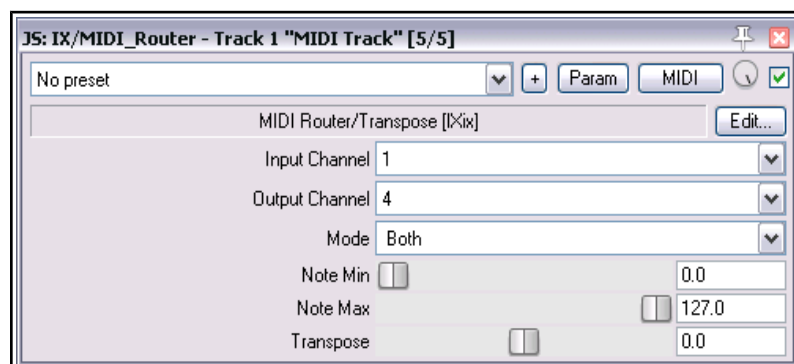

13.44 Working with Piano Roll Synced to Project Arrange View

Here is one example of how you can work with the MIDI Editor piano roll synced to the project. This is what we have done:

1. Recorded a percussion instrument as a wave file and, using stretch markers, dynamic splitting, or any other technique, edited this item so that the notes are exactly as we want them.
2. Created a new empty MIDI item and opened it in the MIDI editor.
3. Used the MIDI editor command **View, Piano roll timebase, Project sync.**
4. Right-clicked on title bar and chosen **Dock Window.**
5. Clicked on the ! in lower left corner of docker and deselected (i.e. unticked) the option **Attach docker to main window.**
6. Clicked on the ! in lower left corner of docker and chosen **Set opacity, 75%.**

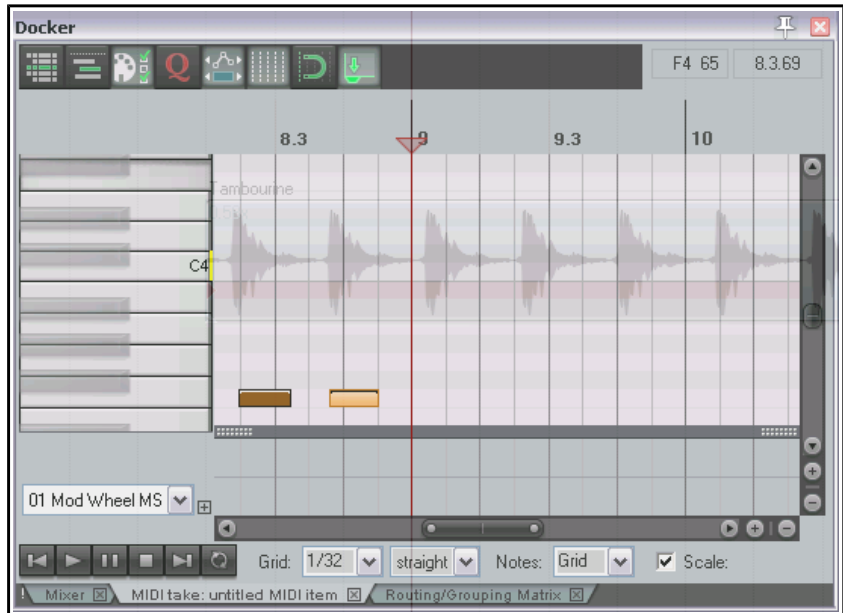

We can now move the MIDI editor window and place it over the previously recorded track: this helps us visually in using the MIDI editor to add the notes for our next percussion instrument.

13.45 The Scale Finder

REAPER's main Arrange View includes a feature that MIDI users may find useful – the Scale Finder. It can be used to identify those scales which contain any given set of notes.

The Scale Finder is opened using the command **View then Scale finder.** Notes can be typed from the computer keyboard or entered using a MIDI device (including the Virtual MIDI Keyboard).

The file sample reascale (provided and installed with REAPER) can be used with the scale finder, or you can click on the button at the bottom of this window and use the Load command to import a file of your own choosing.

You also have the option to use the notes that are currently selected in the MIDI Editor.

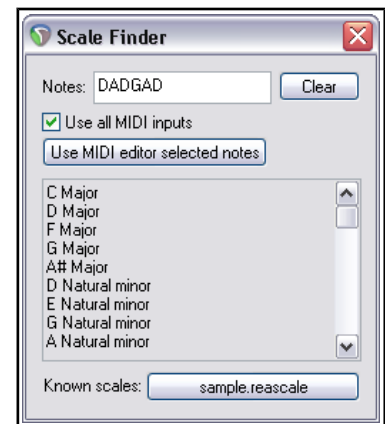

13.46 Sequencer Megababy

Sequencer Baby is a pattern sequencer which can be used to play a MIDI synthesizer under program control. This section is intended to introduce relatively new users to the concept of pattern sequencing, together with a simple example of how one can be used. Beyond this, don't hesitate to explore and experiment for yourself!

We'll start by working thru a step by step example, then go on to examine Sequencer Megababy in more detail.

Example

1. Create a new file, and insert a single track.
2. Open the track's FX chain and add an instance of **JS: MIDIsequencer_megababy.**
3. You need a synthesizer to use with Sequencer Megababy. You could use one of your choice, but for this example insert an instance of **ReaSynth.** For now, leave its settings at their defaults, except (as a precaution) Volume. Set this to about -15 dB. If this turns out to be too low, you can later raise it.
4. Also as a precaution, insert the **JS: Utility/limiter** and set **max vol** to -3.0 dB.
5. Select the Sequencer Baby plugin. Some of its main controls are shown below.

Up and Running: A REAPER User Guide v 5.24

- Click and drag in a few places (example shown right) to enter a note pattern.
- Click **Play** on REAPER's transport bar. This pattern will play over and over again.
- Stop playback. Change the **Steps per beat** value to 8 and play again. Notice the music plays faster.
- Set this to 2: notice playback becomes slower. Set this back to 4.
- Change **Sequence length** to 24. The sequence becomes longer. Draw some more notes.
- Click on the number **1** above the pattern grid (but below the parameter controls). A new screen is shown: here you can create another pattern. Do this!
- Now hold the **Alt** button while clicking on the number **1** button. Notice the column headers change color.
- Play the music. The two patterns (0 and 1) are now chained. You can chain up to 16 patterns.
- If you wish, save the file.
- You can also record the synth's output as an audio item. Arm the track for recording, choose **Record output** from the record arm context menu, then press **Ctrl R**.

Note: The four lanes below the pattern grid area can be used to set modulation, volume, pan and/or expression values for individual notes or any sequence of notes.

Click/sweep to create an envelope:

right-click on any node to delete it, right-click/sweep to delete entire envelope. Shown here is a pan example.

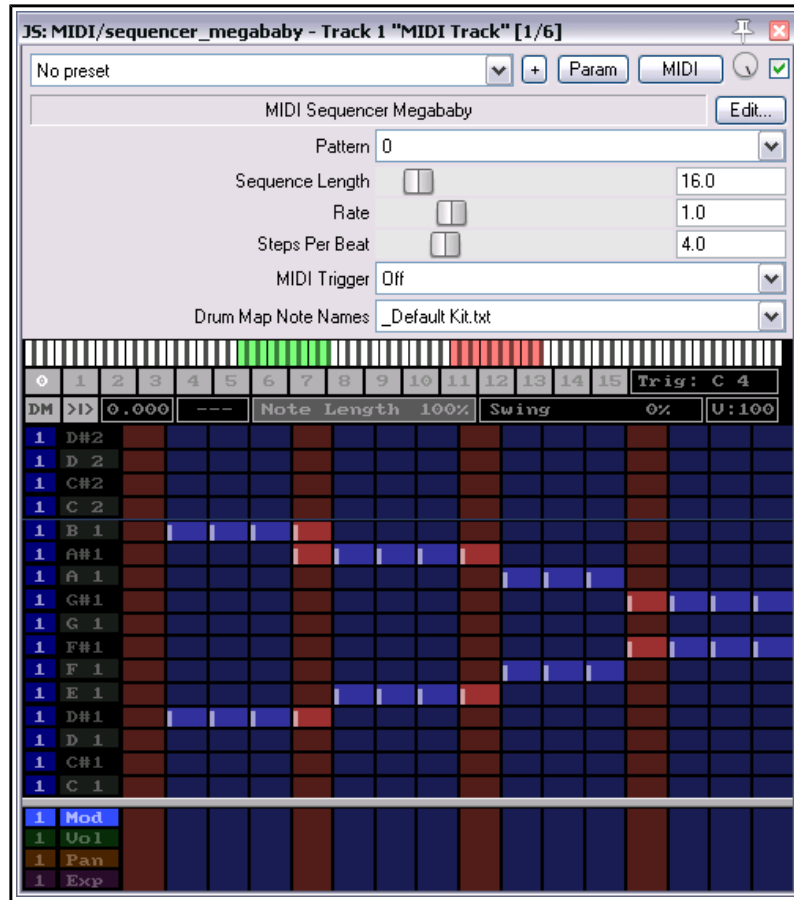

Summary Examples of Sequencer Baby Keyboard/Mouse Control Combinations

Left click-drag	Draw new notes/ erase existing notes.
Right click-drag	Audition notes without drawing.
Shift Ctrl Alt Left click-drag	“Sweep” draw notes freehand / erase existing notes.
Ctrl Left click-drag	Adjust note velocity.
Shift Left click-drag	Adjust note start offset..
Ctrl Left-click / Ctrl Right-click	Halve steps per beat, slow down / Double steps per beat, speed up.
Left click pattern number	Select pattern number.
Ctrl right-click pattern number	Clear pattern.
Alt Left-click pattern number	Set pattern chain end.

A more complete list can be displayed by clicking on the plugin's **Edit** button.

13.47 Using MIDI CC Messages to Control FX Presets

This is an advanced topic and as such not recommended for novice users.

Bank/Program Select CC messages can be used to switch programmatically between presets for any FX on any track during playback in real time. This can be done using a dedicated MIDI item that is placed on the same track as the media item containing the FX whose presets you wish to automate. The procedure can be a little bit “fussy” so be prepared to take your time over this, especially at first, until you get used to it.

13 - Manipulating and Editing MIDI Items

1. After recording the item, insert the required FX into the track's FX chain and (if it is not already displayed) import the required preset library. To do this, click on the **+** symbol to the right of the presets drop down and choose **Import preset library (.rpl)**.
2. The available presets can now be displayed from the presets drop down list. The example here shows the default presets library for ReaDelay, but you can do this for any plug-in. You could delete any presets that you do not wish to keep and/or create and save more presets of your own if you wish. The self-evident commands for doing this can be found on the same presets **+** menu that you used in step 1. above. If you do this, it is recommended that you then export the presets library with a new name.
3. For the purposes of this example, we will be content to use just the supplied set of ReaDelay presets shown on the right.
4. You now need to create a .reabank patch/bank file. This is in fact an ordinary text file, but it must be laid out in a certain way, and it must be saved with a .reabank extension. You can use any text editor for this.
5. Joel Sampson has available (free of charge) on his web site an excellent and comprehensive five page PDF manual explaining just about every aspect of reabank files and how to create them. Summary instructions follow below, but I would strongly recommend that you download and study **The Art of Reabanks** from www.djembe.com/reaper.html
6. An example of a reabank file for the default ReaDelay preset library is shown below. In this case, Notepad has been used to create the file. Note the comments at steps 7 and 8.
7. The bank line is the first line of the file. It sets the most significant byte (MSB) and least significant byte (LSB) of the Bank Select number, then the bank name. You can set both numbers at zero.
8. Each subsequent line consists for each preset of its patch number (starting at zero) and its name, which is shown here the same as the name displayed in the FX presets drop down. However, you may use different names if you wish, as the selection process is based on the patch number.
9. Save the file and close the text editor when finished. A fairly sensible place to save it is in a subfolder of your \Application Data\REAPER\Data folder or equivalent (depending on whether you are using Windows or OS/X, and which version) – but that's up to you.
10. Start REAPER and open the appropriate track's FX chain. Select the FX and from the preset **+** menu select **Link to MIDI program change** and select a channel (e.g. Channel 16). This will make the controlling MIDI messages distinct from any others.
11. From the track's context menu, set **Enable track free item positioning** on. This command will now appear on this menu with a tick beside it. By enabling free item positioning you ensure that you can place two or more items underneath each other on the same track.
12. Select the track that contains the media item with the FX plug-in whose presets you wish to control. Use your mouse to make a time selection that includes this item. Now from the **Insert** menu choose **New MIDI item** to create an empty MIDI item alongside (parallel to) the existing media item. The result of this is shown below:

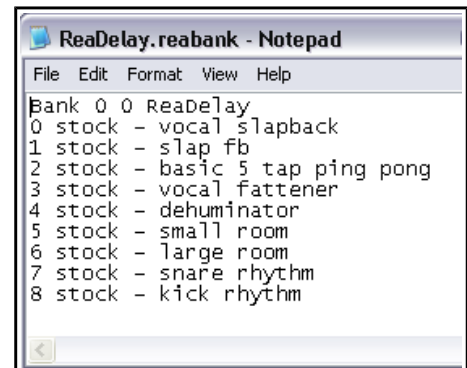
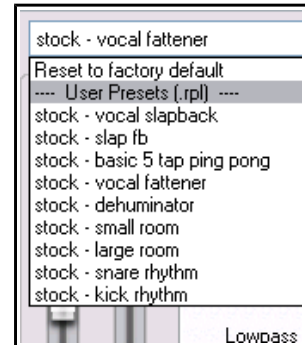

13. Open the empty MIDI item in the MIDI Editor, and make sure that the **Bank/Program Select** lane is displayed.
14. At the point where you want to make your first automated preset change, double-click in the Bank/Program Select CC lane. This will display the Bank/Program Select dialog box.

Up and Running: A REAPER User Guide v 5.24

15. Click on **Load File**. Navigate to and select the file that you saved at step 9. and click on **Open**.
16. The preset bank will now be loaded. Display the Program drop down list and select the required preset (see right). Be sure to select the same channel as you specified at step 10. Click on **OK**.
17. Repeat step 16. as many times as you wish to create as many automated preset changes as you require.
18. You should now be able to see your program changes displayed in the MIDI Editor CC lane (see below).
19. Play the song. Your ReaDelay presets will now automatically change according to your instructions!

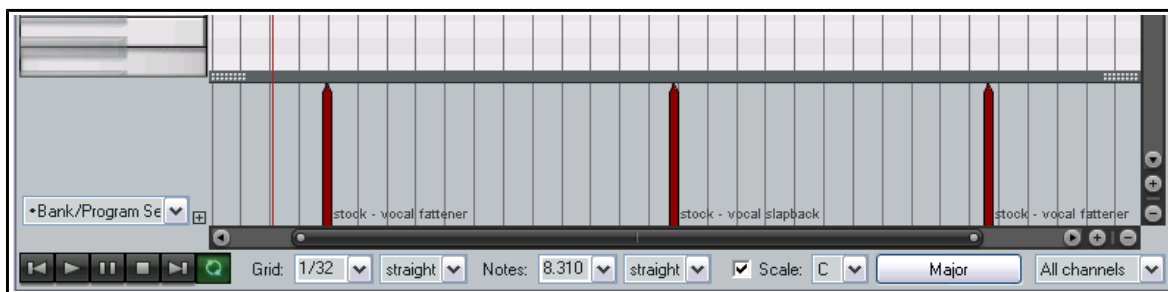
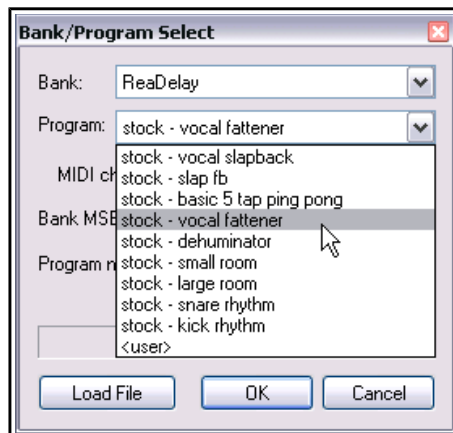

14 Music Notation and REAPER's Notation Editor

14.1 A Brief Introduction to Notation

In a broad sense, the term *notation* can be applied to any system that uses written symbols to represent musical notes. Thus, the piano roll view of REAPER's MIDI Editor can be seen as a type of notation, as is the use of guitar tabs, which you might have encountered elsewhere. However, in practice the term "notation" is often used to refer to modern staff notation. This was developed for use with European classical music, but is now widely used to represent music of many genres. This chapter will focus on the use of REAPER's notation editor for modern staff notation. First, here is a general introduction.

The practice of notation writing is sometimes also known as *scoring*. Notation is a huge subject about which there is much to learn, and the journey from complete beginner to competent achiever can be a long one. Many books are available on the subject, including *Music Notation (Theory and Technique for Music Notation)* by Mark McGrain and *Music Notation and Terminology* by Karl Wilson Gehrkens (available on line as a free download from Gutenberg). A handy short general introduction to understanding music theory and notation can be found on line at method-behind-the-music.com and some introductory tutorials at www.musicians-place.com/harmonics/course-1/staff-notation.html.

If all this intimidates you, don't let it! You don't need to be able to read or write musical scores to be a musician. Robert Johnson, John Lennon, Paul McCartney, Jimmy Page, Jimi Hendrix, Eric Clapton, Tommy Emmanuel and many, many others are all proof of that!

This User Guide does not aim for the impossible goal of teaching everybody everything they could ever wish to know about notation scoring and editing, in just a few pages! Its purpose is to help you to learn how to start using REAPER's notation editor with such knowledge and skills as you can bring to the table.

Below are illustrated some of the basic elements and terminology of notation scoring:

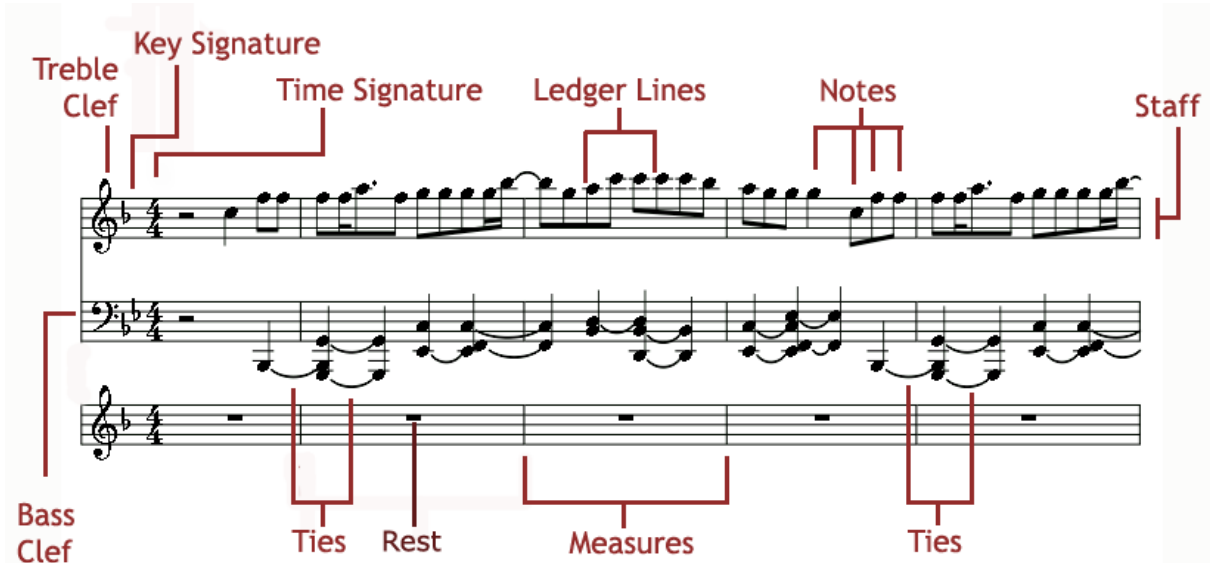

The **staff** is the five line grid on which notes can be written, and which is used to display the notes. If a MIDI item recorded using a keyboard or created by hand within the MIDI editor is opened in the notation editor, then that item will be automatically scored. You can also edit that score, or add to it, within the notation editor. The staff is divided into a number of **measures** for the duration of the piece. The number of beats to a measure is itself determined by the **time signature** (see also below).

On the left end of the staff is displayed the **clef**. For the **treble clef** the first (lowest) line of the staff represents **E** this goes up alternately thru grid spaces and lines to **F, G, A, B, C, D, E**, and **F**. The **bass clef** uses the same musical alphabet but goes up **G, A, B, C, D, E, F, G**, and **A**. Where a note needs to be displayed above or below the range covered by the staff, this is done using **ledger lines**.

A different symbol is used to represent each **note**, from double whole note or breve (not shown) thru (shown from left to right below) whole note (semibreve), half note (minim), quarter note (crotchet), eighth note

Up and Running: A REAPER User Guide v 5.24

(quaver), sixteenth note (semiquaver), thirty-second note (demi-semiquaver) and sixty-fourth note (semi-demi-semiquaver). Above you can see where **ties** have been used to join together two or more adjacent notes of the same pitch, effectively creating a single longer note.

To the immediate right of the clef are the **key signature** (if present) and the **time signature**. The **key signature** designates notes to be played higher or lower than its corresponding natural note. The **time signature** determines how many beats there are per measure, and what kind of note gets the beat. For example, in 4/4 time there are four beats per measure with the quarter note getting the beat. In 3/4 time also the quarter note will get the beat, but with only three beats in a measure.

Finally in the above diagram you can see **Rests**. A rest represents a period of silence in a bar. The duration of the rest corresponds to a note length and is indicated by the symbol used, as illustrated in the examples shown on the right.

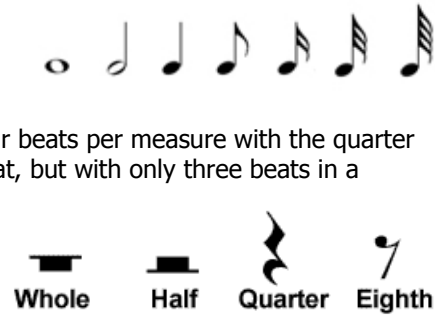

14.2 REAPER's Notation Editor: a First Look

The single most important thing for you to understand about REAPER's notation editor is this:

It is a fully integrated part of the MIDI Editor, not a stand-alone module. Any changes you make when editing will be to the MIDI item itself, and will show up in every view. This architecture has a number of significant advantages, such as:

- ◆ If you are familiar with working in, say, piano roll view, then learning to use the notation editor presents a significantly less steep learning curve than would otherwise be the case. Indeed, you would probably be unwise to attempt to use the notation editor without first getting to know the MIDI Editor, and especially piano roll view.
- ◆ You can make your edits (such as moving, copying or modifying notes) in whichever view you find it easiest to work. The results of the edits will be visible (and audible) in any view.

The MIDI Editor's different views are selected from the **View** menu. The different modes (already introduced in Chapter 13) are:

- Mode: piano roll (Alt 1)**
- Mode: named notes (Alt 2)**
- Mode: event list (Alt 3)**
- Mode: musical notation (Alt 4)**

Consider the example on the right. This is a fairly simple MIDI item. It could have been imported from an external MIDI file, recorded using a keyboard, or crafted in the REAPER Midi Editor piano roll view or musical notation view. It is shown here in piano roll view (top) and musical notation view. When you switch between views, you are seeing exactly the same notes each time.

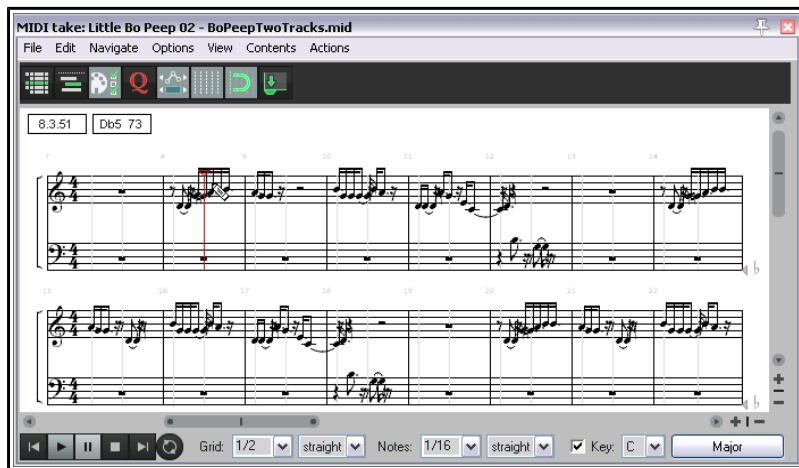
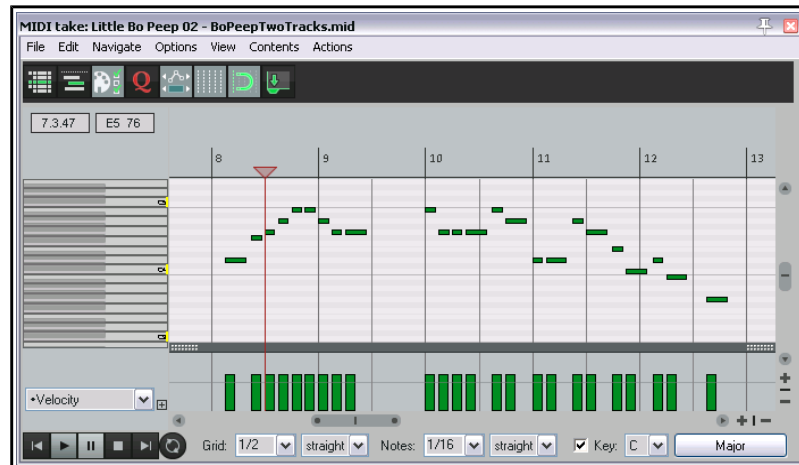

14 - Music Notation and REAPER's Notation Editor

You can also see that the MIDI editor environment is also the same. For example, the menus and toolbars are the same, as is the essential MIDI Editor functionality. In either of the two views shown here, for example, you can add, delete or move notes.

Note that a MIDI item can be displayed in only one view at a time (e.g. musical notation mode or piano roll mode, but not both at once), although different items may be open at the same time in different views in separate MIDI Editor instances.

Note also that the methods employed when working within the different views (or modes) are as far as possible, the same.

For example, use double-click to insert a new note. Use right-click-drag to select a series of notes (marquee). You can perform tasks on your selection such as delete, move, copy, quantize or humanize, and so on. As you will see later in this chapter, musical notation view also incorporates a large number of extra features that are specific to scoring music.

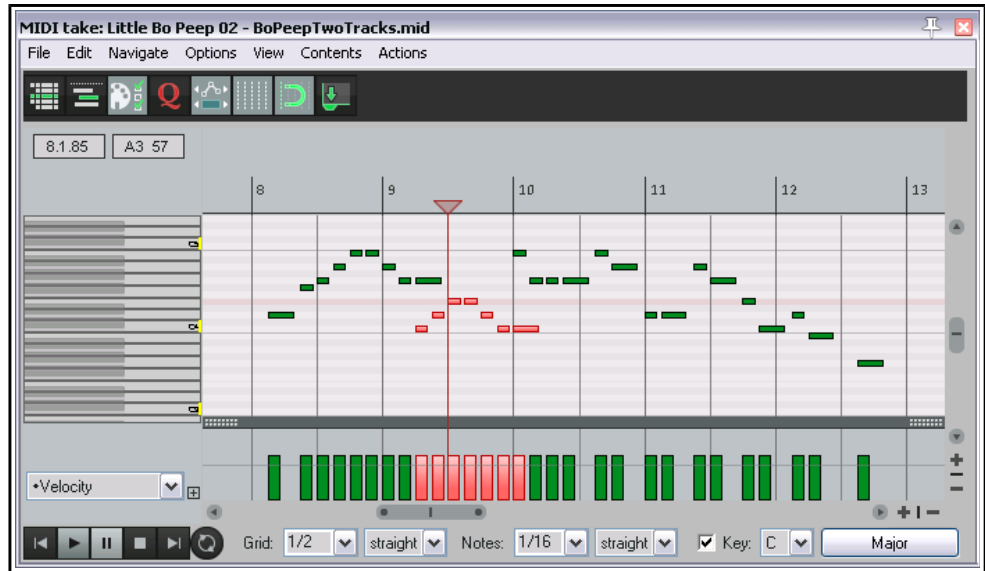

First, let's return for a moment to our simple example.

In this case, we have added some more notes in the piano roll view (shown here as selected).

When we switch to musical notation view, we can see that the edits are also displayed there.

Thus the process of working and moving between the different modes is quite seamless.

If you are working with projects which contain more than one track with MIDI items, and/or more than one MIDI item per track, it is important that you understand your

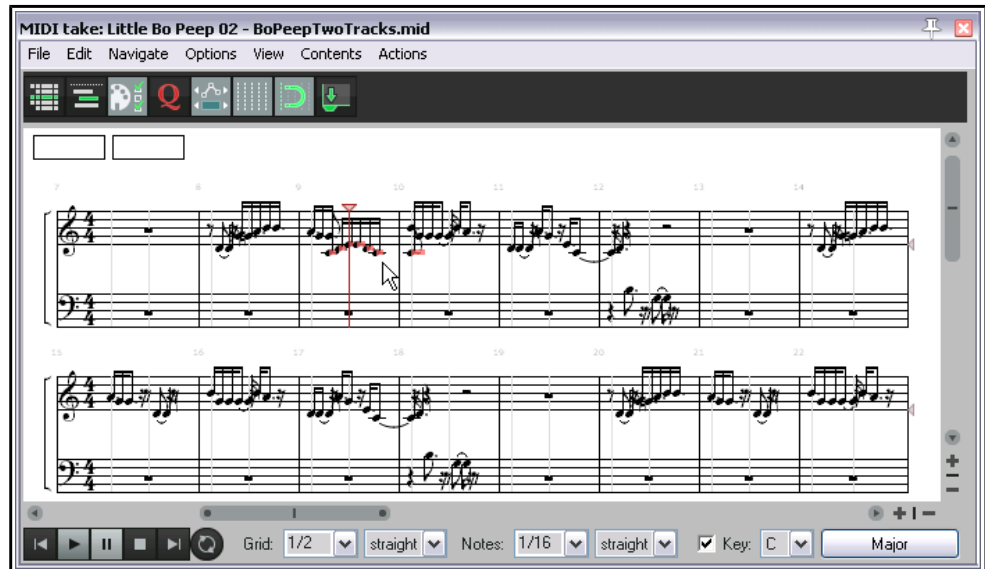

options for managing how the MIDI Editor (including musical notation mode) can handle these. You might already be familiar with this, from sections 13.26 to 13.28 of this guide. If necessary, refer back to these sections, but there follows a brief summary.

14.3 Opening MIDI Items in the Notation Editor

Under **Options, Preferences, Editing Behavior, MIDI Editor** you can specify your default preference as to whether you want one MIDI editor instance opened for each item, for each track, or for the entire project. When in musical notation mode, it can often be helpful to have all MIDI items open together.

On the same page, you can also determine what happens by default when you open a MIDI item in the MIDI Editor, either by double-clicking, or using the **Open in built-in editor** command. The options are to open the clicked item only, all selected MIDI items, all MIDI items

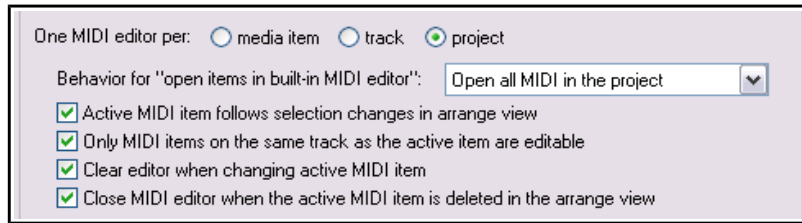

on the same track, or all MIDI items in the project. Your default setting can be overridden for individual projects from the MIDI Editor's Contents menu. There are also a number of other options, shown above.

14.4 REAPER's Notation Editor: A Closer Look

Once opened, musical notation mode can be selected (**View** menu) and the option to view the track list should be enabled from the **Contents** menu. This

can be used, amongst other things, to determine which items are visible and optionally editable, as well as which is to be used when inserting notes (see 13.26 to 13.28). You should make sure that you have a sound understanding of the track list and its features before working in musical notation view.

Shown here is an example of a folder with a synth inserted in its FX chain and three child tracks, each containing a MIDI item. All three are open together in the MIDI Editor's musical notation view. By looking at the panel on the right you should be able to see that all three items are visible in this window.

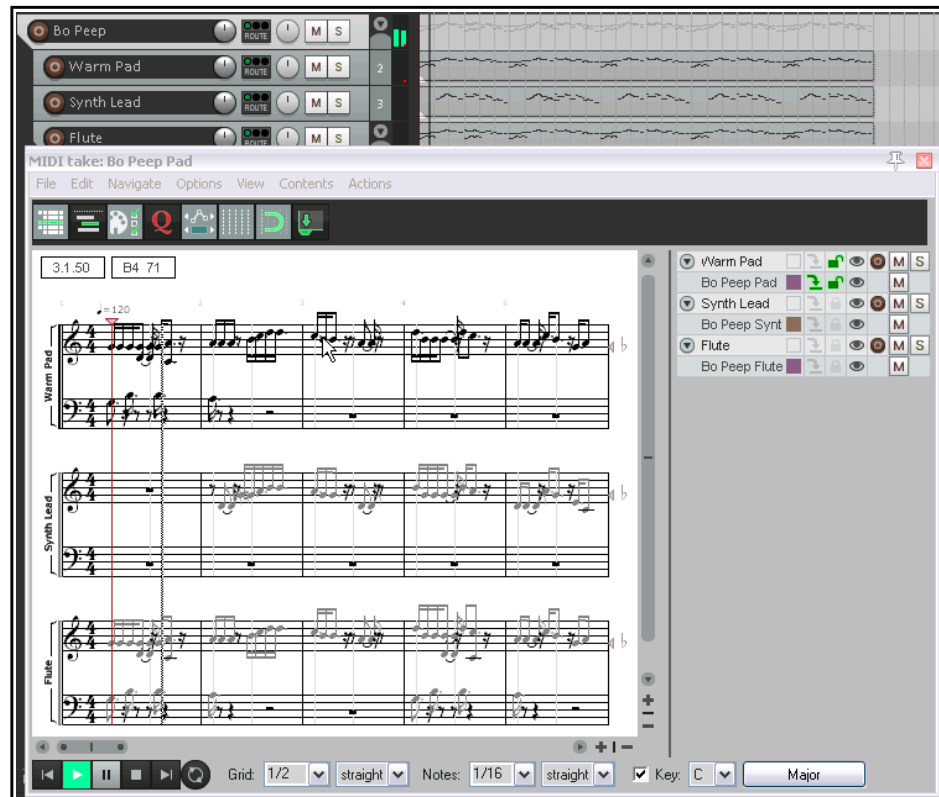

The first of these is the only one currently selected as editable and it has also been selected for inserting any new notes.

Let's look first at some of the things that you can already see here:

- ◆ If more than one track is visible, track names are displayed to the left of the staff. Both track and item names are visible in the track list panel. Clicking on the track name (in the notation or in the track panel) will make that track the target track for inserting events, and will make the items on that track editable.
- ◆ Notes that are not currently editable are shown in a lighter shade of gray.
- ◆ There are two boxes at the top left corner of the display, just below the toolbar. If you hover your mouse over any note, these boxes will display that note's time position and pitch.

14 - Music Notation and REAPER's Notation Editor

- ◆ The tempo is displayed above and slightly to the right of the time signature.
- ◆ To the right of the page, at the end of each pair of rows there is a pitch cursor in the form of a small gray triangle. This shows the current pitch that will apply when keyboard actions such as insert note are applied. An accidental (sharp or flat) will be shown beside it if the pitch is not in the current key. This symbol is editable by dragging up or down with the mouse.

Now let's take a look at some other features that might not be as immediately apparent. You can see several things in this illustration, which will be explained shortly.



- ◆ Lyrics have been added just below the first staff.
- ◆ Notations (in this example, crescendo, play very loud, and diminuendo) have been made above the staff.
- ◆ A time selection and separate loop selection have been made. This could initially have been done in arrange view, but can also be edited in notation mode. For example, you can grab the handles with the mouse to adjust the start and end points of the loop.
- ◆ Some notes are also marked with color. These are the currently selected notes. How they are colored will depend which option you have set – channel or velocity or pitch, etc. Setting color to velocity can be especially useful, as in notation (as opposed to piano roll view) there is no other way to display velocity.

Example

Before digging any deeper, familiarise yourself with the basics of the musical notation mode environment. Make a copy of one of your MIDI projects, then, as a first exercise, strip it back to a few simple MIDI items on no more than two or three tracks.

Open this in the MIDI editor and get used to the feel and flavor of musical notation mode. Don't yet be too ambitious: restrict yourself at first to simple tasks like adding or deleting notes, moving or copying loop selections, etc. Get to grips with switching between modes and editing in both. Don't worry if you mess it up occasionally – it's just a scratch pad!

We'll get to explaining how you manage the other (and perhaps more interesting) features shortly, but there's a couple of other points worth making first.

14.5 Notation Editor View Options

The MIDI Editor main menu **View** command includes a number of notation view specific options:

Proportional (musical) note spacing.

Enabling this option selects proportional note spacing rather than absolute spacing (as in piano roll view) - see images, right. With absolute spacing (top image), the timing grid is evenly spaced, and the notes placed in their absolute timing positions on it. With proportional spacing (lower image) the grid is adjusted to suit this: longer notes need not take up their larger actual time-portion of the bar and the grid tends to be narrowed, shorter notes are no longer compressed into their actual short time-space and the grid is widened accordingly.

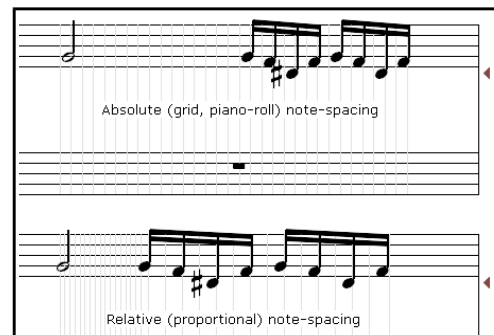

Continuous view always, regardless of zoom level

This toggle option determines how your notation is displayed in the MIDI Editor: it is explained in section 14.7.

Display pedal events

A toggle to determine whether or not pedal events are shown.

Bracket tracks by folder

Up and Running: A REAPER User Guide v 5.24

Enabling this option will cause a bracket to be drawn to the left of the score to indicate where a number of consecutive tracks belong in the same folder.

Color note heads

Determines whether or not note heads are colored in accordance with whichever option has been selected (**View, Color notes by** command).

Automatically detect triplets

Toggles this option on and off. Tuplets and triplets are discussed later in this chapter.

Automatically voice overlapping notes.

Voicing allows the notes that make up a chord to be arranged in various ways so as to vary the sound. The automatic voicing of overlapping notes can be toggled on and off.

Show project tempo changes

A toggle to determine whether or not project tempo changes should be displayed above the score in the notation editor.

Key signatures

Allows you to specify how key signature should be managed. Sub-menu toggle options are **Key signature change affects all tracks** and **Transposing display affects key signatures..**

Display quantization

The default setting is 1/16 but you can use the slider to instead choose 1/64, 1/32 or 1/8.

Display quantization, Minimum note length

The default setting is 1/64, but you can use the slider to instead choose 1/256, 1/128, 1/32, 1/16 or 1/8.

Neither your display quantization nor your minimum note length settings will affect the underlying MIDI in any way. They only determine how notes are displayed. To understand how these two options work, you need to consider them together.

The display quantization setting ensures that for display purposes all but the shortest notes will be rounded to whatever value is selected. The minimum note length setting allows shorter notes to be displayed regardless of the display quantization setting. For example, if display quantization is set to 1/16 and minimum note length to 1/64 (the default settings), then notes slightly longer or shorter than 1/16 will be displayed as 1/16, those slightly longer or shorter than 1/8 will be displayed as 1/8, and so on. It will, however, still be possible to display notes shorter than 1/16, such as 1/32 or 1/64.

14.6 Basic Note Selection and MIDI Editor Tasks

Basic note selection and MIDI editing tasks are covered in detail in Chapter 13, including the commands on the **Edit** menu. As well as the more obvious commands and actions, there are a number of mouse and keyboard shortcuts. Most mouse behaviors that work in the piano roll will also work in musical notation mode.

Zoom and Scroll

Make yourself familiar with the MIDI Editor's zoom and scroll controls. In addition to the various buttons and sliders displayed in the MIDI Editor window, the following mouse and keyboard actions are also useful:

Mousewheel: Horizontal Zoom (**Num +**, **Num -**) **Ctrl Mousewheel:** Vertical Zoom (**Pg Up**, **Pg Dn**)
Alt Mousewheel: Horizontal Scroll (**Alt Left**, **Alt Rt**) **Ctrl Alt Mousewheel:** Vertical Scroll (**Alt Up**, **Alt Dn**)

Common Tasks

Below are listed some common tasks that can be used in both the piano roll and musical notation mode..

Delete note or note selection	Marquee to make selection, press Delete .
Move note or note selection	Marquee to make selection, Click and drag to new position.
Copy note or note selection	Marquee to make selection, Ctrl click and drag to new position.

The Action List

You also have available to you **Actions:** The MIDI Editor actions list includes the notation mode commands as well as several actions not on the menus that are specific to notation mode, for example:

Notation: Hide selected notes
Notation: Unhide all notes

14 - Music Notation and REAPER's Notation Editor

Options like these can be enabled or disabled. You can also assign your own shortcut keys for any actions, or add them to the MIDI Editor's menus or toolbars. The actions list is covered in more detail in Chapter 15: some time spent browsing thru this list could prove to be time well spent.

Default Mouse Modifiers

REAPER includes a large number of default mouse actions. These can be customised to suit your own requirements thru the **Editing Behavior, Mouse Modifiers** page of your preferences. To do this, first select the MIDI piano roll context, then one of the actions left click, left drag or double click. You then double click on a modifier (e.g. Shift+Ctrl or Ctrl+Alt) to display a list of options.

Shown here (right) are the default settings for MIDI piano roll double click. You can select any modifier (e.g. Ctrl Double click) and assign to it an action of your choosing.

Listed below are REAPER's default MIDI piano roll mouse and musical notation modifiers. MIDI Editor mouse modifiers were introduced in Chapter 13, and you can learn more about them in Chapter 15.

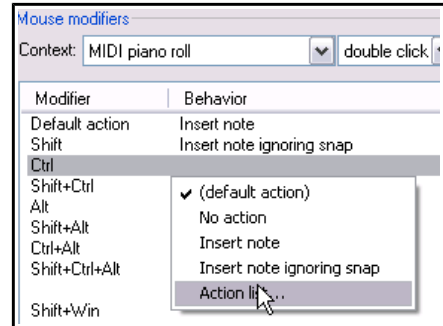

Left Click

Default action	Deselect all notes and move edit cursor.
Ctrl	Deselect all notes and move edit cursor, ignoring snap.
Alt	Deselect all notes.
Shift+Alt	Insert note ignoring snap.
Shift+Ctrl+Alt	Insert note.

Left Drag

Default action	Insert note, drag to extend or change pitch.
Shift	Insert note ignoring snap, drag to extend or change pitch.
Ctrl	Copy selected note(s).
Alt	Erase notes.
Shift+Alt	Paint notes, ignoring snap.
Ctrl+Alt	Paint a straight line of notes.
Shift+Ctrl+Alt	Paint notes and chords.

Double click

Default action	Insert note.
Shift	Insert note, ignoring snap.

You can double-click on any item in the Behavior column to select from a list of alternative actions where available (see right), or to open the action list and select another action.

You should also make sure you understand the purpose of the MIDI Editor's other controls, especially those located near the bottom of the window, to the right of the transport bar. These are labelled **Grid**, **Notes**, **Scale**, etc. For example, the Notes drop down list sets the default length for new notes when they are inserted. If necessary, refer back to Chapter 13, section 13.6.

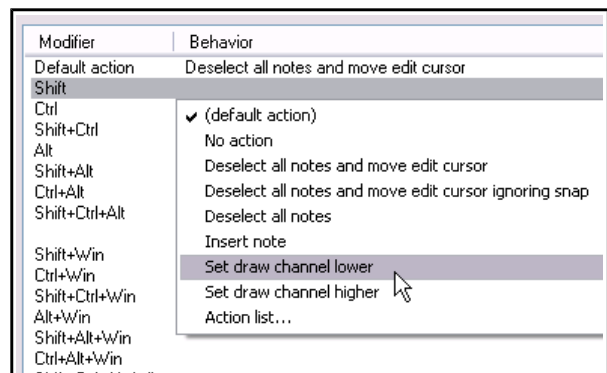

14.7 Notation Editor Specific Tasks and Functions

Before delving too deeply into the notation mode's editing capabilities it's worth pausing to take on board a few **important points**:

- ◆ If you have several MIDI items open together in a single notation editor you should display the track list (**Contents**, **Track list**). This enables you to make sure that any item that you wish to work on is at least

Up and Running: A REAPER User Guide v 5.24

editable, and, for many actions, also selected as the target for inserting events. One simple way of doing this is to make it the only item visible at the time (below right).

- ◆ Within the MIDI editor track list, you can use **Ctrl Click** on any track name to close a track, or **Alt Click** to close all other tracks.
- ◆ Each MIDI item can have its own key signature, or no key signature. If no key signature is specified for an item, it will take its key signature from the previous item on the same track. If there is no previous item on the same track and no key signature defined, it will not have a key signature.
- ◆ Only a relatively small number of the commands that are exclusive to musical notation view *affect the actual MIDI notes themselves*. These include deleting and inserting notes and setting tuplets. Other actions such as articulations, lyrics, notations, etc. *will only affect what is drawn on the page, not the underlying notes themselves*.
- ◆ You can right-click on the timeline (which displays the bar/measure numbers) to access the MIDI editor's general context menu.

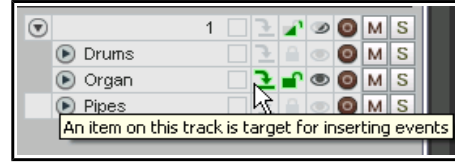

How the score is displayed

When only a single track is being viewed, the notation will by default be displayed as a page, running from left to right and top to bottom, unless you are zoomed so closely as to display less than one full measure.

When less than a full measure or more than one track is displayed, the display is continuous, running always and only from left to right. The MIDI Editor's main **View** menu includes a toggle **Notation view options, Continuous view always**. Enable this if you wish to use continuous view regardless of zoom level.

MIDI Track/Measure Editing Commands and Options

Track/measure task	Method
Change default clef	<p>To change the default clef, right-click over the vertical bar at the start of a measure and select Default clef from the menu. Options are Treble + Bass, Treble, Bass, Alto, Tenor, Treble -8, Treble +8, Treble+15, Bass -8, Bass-15, Percussion or Percussion (one staff line). As its name implies, this last option creates a staff of only one line.</p>

14 - Music Notation and REAPER's Notation Editor

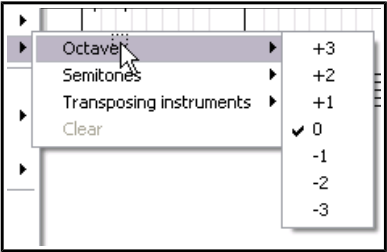
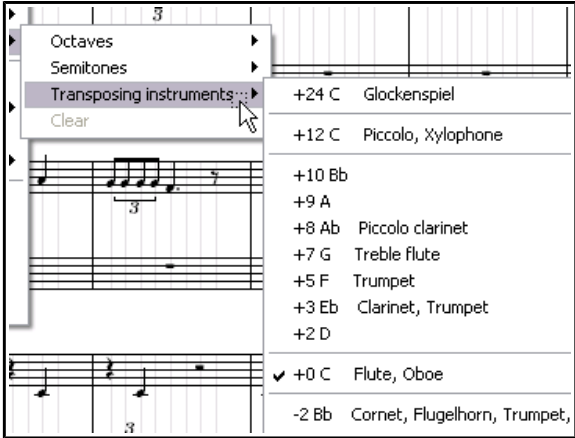
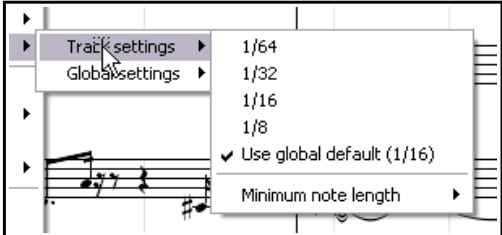
Track/measure task	Method
<p>Transposing note display: Octaves and Semitones</p> <p>(See also Transpose Options.)</p>	<p>The Transpose display command can be used to cause the notes on a track to be displayed up or down by up to 3 octaves and/or 11 semitones. This affects only the way notes are displayed, not the underlying MIDI. Right-click at the start of a measure, choose Transpose display from the context menu, then select Octaves or Semitones.</p> <p>Octaves can be transformed within a range of +3 to -3.</p> <p>Semitones can be transformed within a range of +11 to -11.</p> <p>You can transpose by a combination of octaves and semitones if you wish: simply use this command twice.</p> <p>Use the Clear command from this menu to restore transposed notes to their previous state.</p> 
<p>Transposing note display: Instruments</p> <p>(See also Transpose Options.)</p>	<p>To transpose notes for a specific instrument, choose Transpose instruments from the Transpose display menu, then make your choice.</p> <p>Part of the range of options for transposing instruments is shown on the right.</p> <p>For example, to transpose the <i>display</i> for a clarinet you would select +3 Eb. It is important to understand that transposing display by itself does not result in any changes being made to the actual MIDI data.</p> <p>Note, however, that you do also have an option to allow transposing display to affect key signatures. This is discussed towards the end of this table.</p> <p>Use the Clear command from this menu to restore transposed notes to their previous state.</p> 
<p>Display quantization</p>	<p>This command can be used to change your Global quantization settings (also accessibly from the View, Notation view settings menu), or to use different quantization settings on a per track basis.</p> <p>See also Notation Editor View Options for further information.</p> 
<p>Changing the clef</p>	<p>To insert a new clef at the start of a measure, right-click on the bar and choose Change clef then select from the list of available choices. These choices are the same as those available on the Default clef menu.</p> <p>To delete such a clef, right click and choose Delete from the change clef menu.</p>

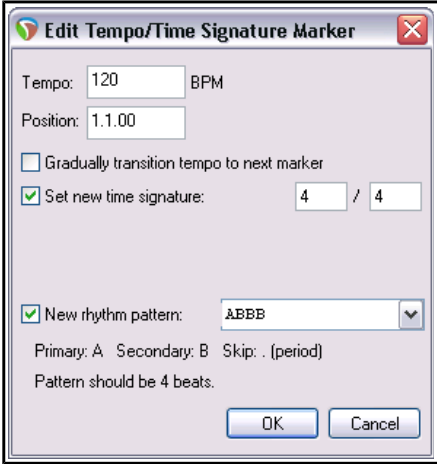
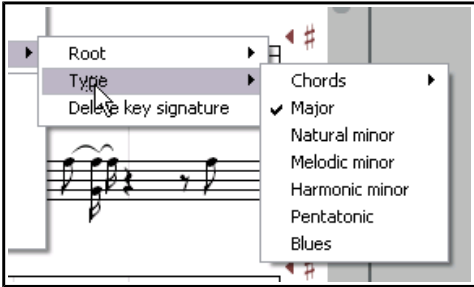
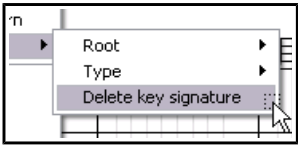
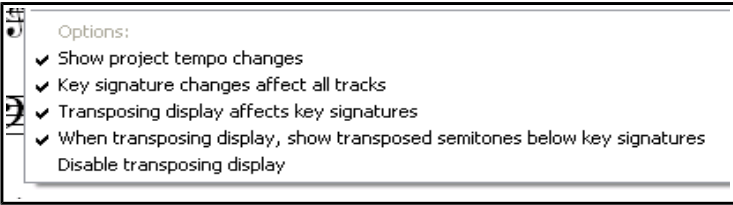
Track/measure task	Method
<p>Change tempo/ time signature/ rhythm pattern</p>	<p>To insert a time signature change at the start of any bar, right-click and choose Change tempo/ time signature/ rhythm pattern from the menu.</p> <p>This opens a dialog box (shown right) where you can make your changes.</p> <p>You can also change an existing tempo, time signature and/or the rhythm pattern setting in this way.</p> <p>Click OK to confirm.</p> 
<p>Change key signature</p>	<p>Use this command from the context menu to insert a key signature change at the start of a bar.</p> <p>You can then select a root and type from the flyout menu.</p> 
<p>Delete a key signature</p>	<p>Right-click over the key signature and choose Change key signature then Delete key signature from context menu.</p> 
<p>Options</p>	<p>The final group of items on this menu are a set of five toggle options.</p> <p>Their meaning should need no further explanation:</p> <ul style="list-style-type: none"> Show project tempo changes Key signature changes affect all tracks Transposing display affects key signatures When transposing display, show transposed semitones below key sigs Disable transposing display 

General Editing Commands and Actions

You can right-click just about anywhere except on a note or item to display a general menu of notation editing commands. These include the usual general editing commands (Copy, Cut, Paste, etc.) as well as these notation view specific commands:

- Dynamics**
- Lyrics**
- Tuplet**
- Pedal**
- Voice**
- Hide Notes**

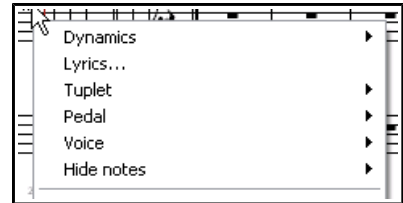

These are explained in the table below.

General editing task	Method
Dynamics	<p>Click on the staff to move the edit cursor to the required position. Right-click and choose Dynamics from the menu.</p> <p>This causes a flyout menu to be displayed, from which you can make any of a number of choices, such as:</p> <p>Text (type your own) Crescendo (gradually increase volume) Dimuendo (gradually reduce volume) pppp (as softly as possible), ppp (very, very softly), pp (very softly), p (softly) mp (mezzo piano, moderately soft), m (mezzo, moderately), mf (mezzo forte, moderately loud) f (forte, loudly), ff (fortissimo, very loud), fff, (very, very loud) ffff (as loud as possible).</p> <p>An example of how this is displayed is shown here. These notations are performance instructions only: they do not affect the MIDI data in the file.</p>
Change a dynamic notation	<p>To change a dynamic notation from one menu item to another (e.g. from pp to ppp), right click on the notation and make your selection from the menu.</p> <p>To change a notation from a menu item (such as pp or ff or crescendo) to text, double click on the notation, type the text and press Enter.</p>
Extend or shrink a crescendo or dimuendo	<p>Hover your mouse over the start or end of the item, so that the mouse cursor changes to a double-headed arrow. Click and drag left or right, as required.</p>
Remove notation	<p>Click on the notation, press Delete key.</p>
Move a notation or lyric	<p>Hover your mouse over the middle of the item, then click-hold-drag to drag and drop the item to its required position.</p>

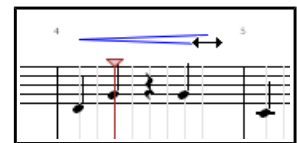
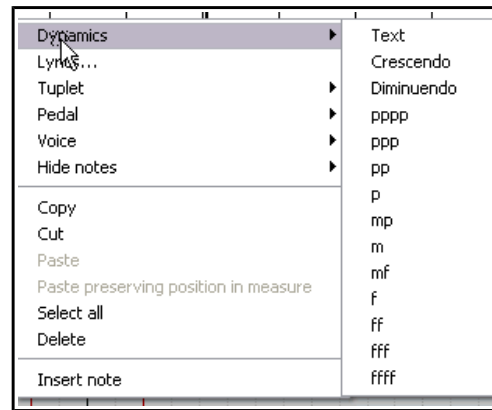

Up and Running: A REAPER User Guide v 5.24

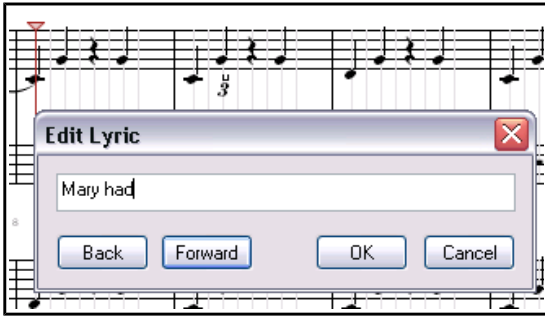
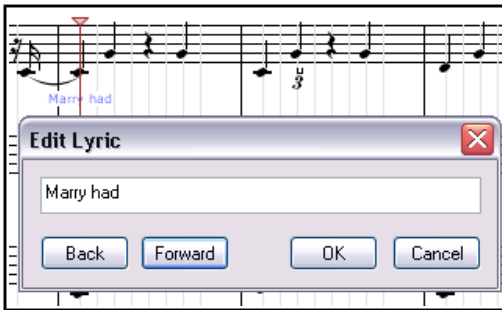
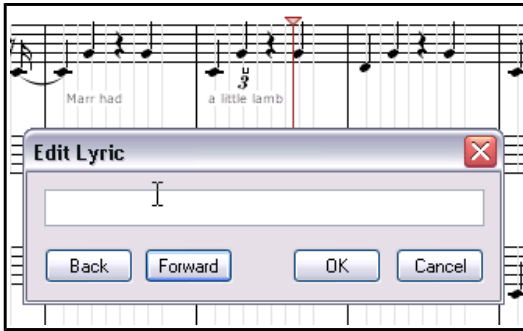
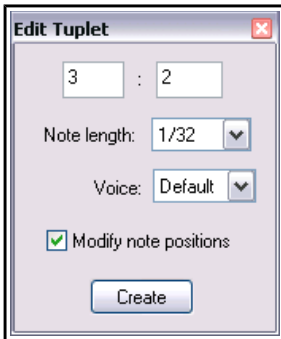
General editing task	Method
<p>Insert a lyric</p>	<p>Click on the staff to move the edit cursor to the required position. Right click and from the context menu choose the Lyrics command. Type your text and click on OK.</p> 
<p>Remove lyrics</p>	<p>Click on existing lyric text, press Delete key.</p>
<p>Edit lyrics</p>	<p>Right-click over text to open text window. Make your changes and press Enter. You can also drag and drop to move lyrics.</p> <p>Lyrics can also be edited in event list mode (as, of course, can other events).</p> 
<p>Insert sequential lyrics</p>	<p>Type the first part of the lyrics in the Edit lyric box, then click on Forward. With the cursor in the edit box, click Forward to move the cursor forward as required, then type the second part of the lyrics in the box. Repeat this process until finished, then click OK.</p> <p>The Back button can be used to move back thru your lyrics, for example to edit them.</p> 
<p>Insert tuplet</p>	<p>A tuplet is an irregular rhythm that involves dividing the beat into a number of subdivisions which differ from those usually allowed by the time signature.</p> <p>To insert a tuplet, first position the edit cursor, right click and choose Tuplet then Create tuplet... from the context menu.</p> <p>This causes the Edit tuplet dialog to be displayed. By default, a triplet (3:2) will be specified, but you can change this as you wish. You can select a note length within the range 1/128 to 1/2, and assign a voice (high or low) if you wish, or accept the default. Your other option is whether to allow note positions to be modified.</p> <p>Click on Create to create a tuplet bracket as a separate item on the staff. You can drag and drop this around as you wish.</p> 

14 - Music Notation and REAPER's Notation Editor

General editing task	Method
<p>Insert tuplet (cont.)</p>	<p>Tuplets will impact on the actual MIDI events, e.g. by changing the original note position or length. Notes will snap to the tuplet stops as you edit them.</p> <p>For example, a quarter note triplet starting at the beginning of the measure will span the first two beats of the measure and contain a stop at 2/3 beats and a stop at 4/3 beats (each quarter note triplet is 2/3 QN long, because a triplet fits 3 notes in the duration normally taken by 2).</p> <div data-bbox="792 394 1464 569" data-label="Image"> </div> <p>You can also alter the tuplet type after it's created: for example, you can switch a quarter note tuplet *(=3 QN in the space of 2) to a quarter note duplet (2 QN in the space of 3); the component notes will not change, but the tuplet itself will shorten.</p> <p>More commonly used tuplets include 2:3 (duplet), 3:2 (triplet), 4:3, 5:4, 6:4. For example, a quarter note (crotchet) can be divided into three (triplet), five (quintuplet), six (sextuplet) or seven parts (octuplet). However, the Edit Tuplet dialog allows you to define whatever specifications you want for your tuplets.</p> <p>Where necessary, rests will automatically be added for missing notes in a tuplet. Rests are indicated by a symbol which represents the length of the pause.</p> <div data-bbox="1284 863 1464 968" data-label="Image"> </div>
<p>Move, Change or Edit a tuplet</p>	<p>To move a tuplet, simply drag and drop to the required position.</p> <p>To change a tuplet, right-click on the tuplet, choose Edit tuplet... from the menu, make your changes to dialog box settings and click on Apply..</p> <div data-bbox="1198 1024 1464 1356" data-label="Image"> </div>
<p>Remove a tuplet</p>	<p>To remove a tuplet, right-click on the tuplet and choose the Remove tuplet command from the menu.</p>
<p>Understand and manage tuplets</p>	<p>If the option Automatically detect triplets is enabled, then triplets will be auto-detected. Auto-detected triplets will be displayed in gray. If you move or alter an auto-detected triplet (not the component notes, but the tuplet bracket itself) it will remain until you manually delete it.</p> <div data-bbox="792 1570 1464 1728" data-label="Image"> </div> <p>Right-click menu options for existing tuplets include Edit tuplet, Tuplet note length (half or double) and Remove tuplet.</p> <p>Tuplets can also be added and attached to note selections as they are inserted. This topic is covered in the next section.</p>

Up and Running: A REAPER User Guide v 5.24

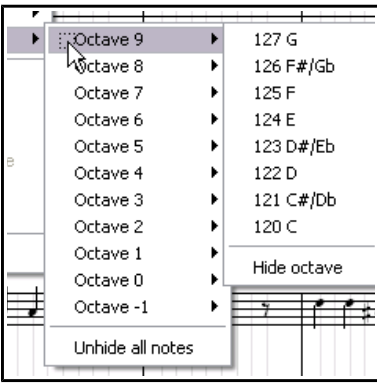
General editing task	Method
Pedal notation	Choose Pedal from the context menu for two pedal notation options – Engage pedal and Release pedal . You also have a toggle option to determine whether pedal notations should be displayed.
Set Voice	<p>The Voice command can be used to select All notes in default voice, All notes in high voice or All notes in low voice.</p>  <p>The method for setting notes to a specified voice is explained in the next table.</p>
Hide Notes	<p>The Hide Notes command can be used to hide notes in any specified octave. It is useful for hiding MIDI key switches or other events not intended to be played as music.</p> <p>Choose this command, then select your required octave from the flyout menu. Next, select a specific note from the list offered, or choose Hide octave to hide all notes in that octave.</p> <p>Repeat the same steps to unhide any specific currently hidden note. To restore the display of all currently hidden notes, choose Unhide all notes from the menu shown here.</p> 



14.8 Working with Notes and Note Selections

A number of commands specific to musical notation view are available from this view's own context menu. Select a note (or series of notes) and right-click to display this menu.

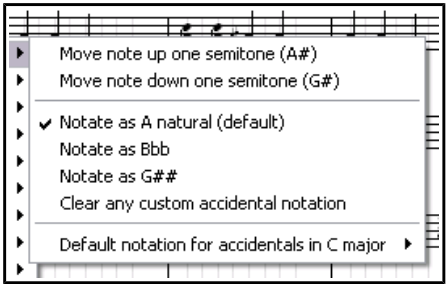
It is well beyond the scope of this User Guide to attempt to teach music theory. Nevertheless, for those that need to learn more, the information in the table below might serve as a starting point by introducing you to some of these terms. These comments are offered for information and guidance only, and are not intended to be comprehensive or water-tight definitions.

Note Option...	Comments ...
Accidentals	<p>Accidentals (sharps and flats) are an instruction to raise or lower the pitch of a note by half a step. Select the note, right-click and select Accidental from the menu. You can then make your choice from the flyout menu. Different values will, of course, be available for different notes.</p> <p>The last of the options on this menu, Default notation for accidentals in C major, can be set to Sharp or Flat.</p> <p>The actions to move the note do actually move the note, not just change the display. If a note can be ambiguously written in either of two ways (for example, C sharp or D flat), the menu will offer a choice of which to display. This will not affect the actual MIDI note, only the notation.</p> 
Stem	<p>This command enables you to over-ride the default stem direction for a note or note selection. Options are Stem up, Stem down, or restore Default stem direction.</p>

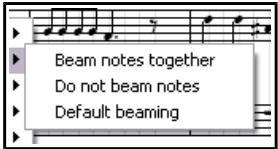
14 - Music Notation and REAPER's Notation Editor

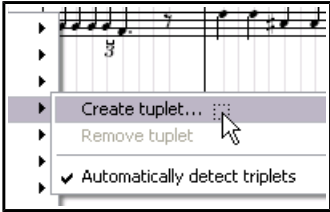
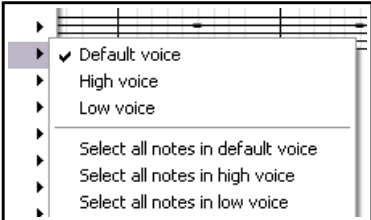
Note Option...	Comments ...
Beam	<p>Right-click on a selected note and choose Beam, then Beam notes together to start beaming on any note. Do not beam notes can be used to remove beaming. This allows you to break up sets of beamed notes to better display the intended rhythm. For example, if four 1/16 notes are beamed together but intended to be phrased as 1+3 then you might wish to start a new beam on the second note. The final option on this menu is Default beaming, which restores a note selection to the default.</p> 
Tie	<p>This menu option can be used with a note selection. Right-click over the selection, then you can choose Tie and Minimize ties to minimize the number of ties in a note selection.</p> 
Tuplet	<p>For detailed information about tuplets, see the preceding table General Editing Commands and Actions. Tuplets can also be defined as an attribute of a selection of notes. For example, you could set three notes to be a tuplet, and REAPER will do its best to figure out the correct start, end, duration of the tuplet based on the note positions, even as they changed around. To do this, make your note selection, choose Tuplet, Create tuplet from the context menu, then enter your required values in the Edit tuplet dialog box. The result of this might not always be to your liking: for this reason, you might prefer to use the method explained in the table General Editing Commands and Actions.</p> 
Voice	<p>Notes can be set to High voice or Low voice. To do this, simply make the selection, then right-click over it and choose Default voice, High voice or Low voice from the context menu. Notes in a given voice will be grouped and beamed together, and have their stems point away from the other voice, for visual identification of separate musical lines. You can also select a voice for a newly inserted note in the same way. From Voice on this menu (or from the general editing context menu), you can Select all notes in high voice or Select all notes in low voice. For high voice notes, articulations will be shown immediately above the notes: for low voice notes they will be shown immediately below the notes. Note also that the Color drop down box includes an option to specify that selected notes should be colored by voice, and that the Voice drop-down determines which voice is assigned to notes as they are inserted.</p> 

Up and Running: A REAPER User Guide v 5.24

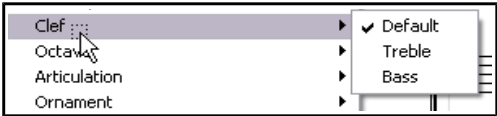
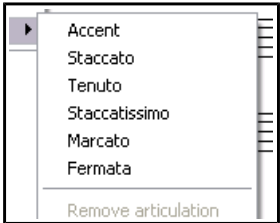
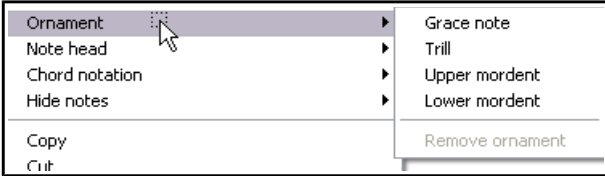
Note Option...	Comments ...
Phrase/slur	<p>Think of a musical phrase as being conceptually similar to a phrase in the English language. Take the example of the old Irish song, Cockles and Mussels. The words "alive alive oh" can be seen to make up a phrase. They belong together, and the end of that phrase would be a suitable place for a very brief pause. Likewise, the musical notes accompanying those words can be said to make up a musical phrase.</p> <p>The curved line that denotes the notes included in the phrase is known as a slur.</p> <p>To define a phrase, first select the notes then choose Phrase/slur, Make phrase/slur from the right-click context menu. A phrase is indicated by a curved line (slur), as shown here. You can edit the phrase as a unit by clicking and dragging on the phrase mark.</p> <p>To select all notes in a phrase, select any note in the phrase, then right-click and choose Phrase/slur, Select all notes in phrase/slur. Phrase/slur, Remove phrase can be used to remove a phrase from a note selection.</p> 
Clef	<p>Use this command to move a note or selection of notes from the treble clef to the bass clef, or vice versa.</p> 
Octave	<p>Use this command to move a note selection outside the staff up or down the display by 1, 2 or 3 octaves.</p> <p>This is another command that does not affect the underlying MIDI notes themselves. Notes that are very high or very low (and far away from the staff) can thus be moved closer to the staff without their pitch being affected.</p>
Articulation	<p>Articulations are used to indicate how individual notes within a passage are to be played – for example emphasised (Accent), brief and detached (Staccato).</p> <p>The options on this menu are shown on the right.</p> <p>These are instructions only, articulations do not affect the actual MIDI events.</p> 
Ornament	<p>Use this command to insert an ornamentation on or after a selected note, or each note in a selection.</p> <p>Options available are Grace note, Trill, Upper and Lower Mordent.</p>  <p>A grace note is an extra note that is added as an embellishment and which is not essential to the harmony or melody. Grace notes will affect the actual MIDI events.</p> <p>A trill (indicated by the letters tr) is used to provide rhythmic, melodic and/or harmonic interest by employing a rapid alternation between two adjacent notes, usually a semitone or tone apart.</p> <p>An upper mordent is a single rapid alternation with the note above. It is often called simply a mordent. A lower mordent (also known as an inverted mordent) is a single rapid alternation with the note below.</p> <p>An ornament can be removed by right-clicking on the note or note selection and choosing Remove ornament from the context menu.</p>

14 - Music Notation and REAPER's Notation Editor

Note Option...	Comments ...
Note head	<p>You can change the graphic used to display your note heads from the standard elliptical symbol to any one of a number of alternatives.</p> <p>Right-click over any note or note selection, then first choose Note head from the context menu followed by either Selected notes (only) or All notes at selected pitch. You can then select from a list of about 20 or so choices.</p>
Chord notation	<p>To identify and notate a basic chord, first select the notes then right-click over the selection and choose Chord notation from the context menu.</p> <p>If a chord is identified, it will be shown as a menu option (see example, right, Gmaj).</p> <p>Click on this text to confirm the chord. The chord name will then be displayed in the score.</p> <p>In the example shown here, a number of chords have been individually identified as either Dmaj or Gmaj.</p>
Hide Notes	<p>Use this command to hide currently selected notes. To unhide hidden notes, choose the Unhide all notes option from the same menu, with any note or notes selected.</p>

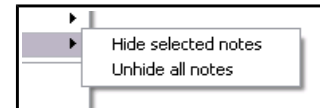
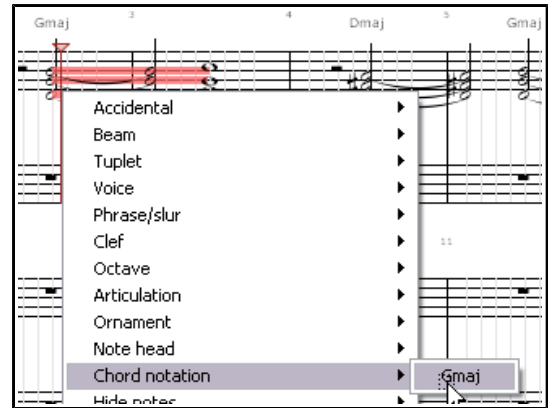
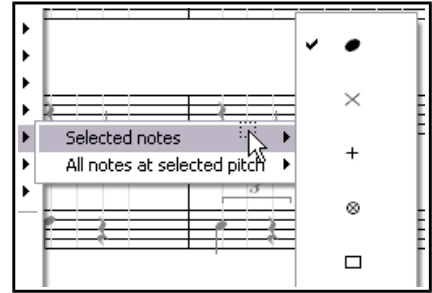

Note: The notations that you create in musical notation view will also be shown in event list view (see Chapter 13).

14.9 Exporting and Importing MusicXML Files

XML Export

It is currently not possible to print your musical notation score from within REAPER. However, you are able to export your score in MusicXML format, which can be read by Finale, Sibelius, MuseScore, Forte, Cubase and many other programs.

To export your score, follow this sequence:

1. Open the score in REAPER's MIDI Editor and select musical notation view.
2. From the menu, choose **File, Notation: Export as MusicXML**
3. Accept the default directory offered, or navigate to another of your choosing. Type a **file name**.
4. Select **score-partwise** or **score-timewise** (see note below).
5. Click on **Save**

The difference between partwise and timewise lies in the priorities that are applied in arranging part and measure elements. If a score contains more than one part elements, each of which contains one or more measure elements, then score-partwise organises the score with part elements at the top of the hierarchy. Score-timewise reverses this hierarchy. If you are unsure as to which to use, accept the default settling.

XML Import

You can import an XML file (for example, as might be produced by MuseScore) by dragging and dropping the file from Windows Explorer or Mac Finder into REAPER's arrange view. When you do this, you will be presented with a number of options.

You will be offered the options to:

Expand the MIDI tracks into an equivalent number of REAPER tracks

Import the MIDI tempo map to the project tempo and **Import MIDI markers (if any) to project markers.**

REAPER will import the file as an in-project MIDI item. This can be opened in the MIDI Editor and edited like any other MIDI item.

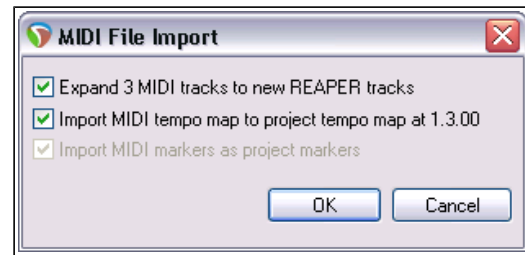

14.10 Making a Notation Editor Toolbar

If you've used other notation editing software, you might think that REAPER is missing something – i.e. a dedicated notation toolbar. That's because you are able to start with a blank canvas and construct your own, adding those commands, actions and options that are most important to you.

Exactly how to do this is explained in Chapter 15. If you search the MIDI Editor's action list you should be able to find what you want. Especially useful might be a whole stack of actions for inserting notes, advancing the cursor or editing notes, using the current note length division type.

15 Customization: Actions, Mouse Modifiers, Menus and Toolbars

15.1 Introduction

Customization is the key to unlocking REAPER's real power and making the program work for you. The more you use the program, the more you will benefit from customizing its many features. Even occasional users will find that they can benefit from taking the time at the very least to tweak some of REAPER's mouse modifiers and keyboard shortcuts. That's what this chapter is about.

By now you should already have come across some of REAPER's options and preferences settings and it's quite likely that you might have already changed some of these to suit your own workflow. This chapter really lifts the lid on customization and will guide you thru the following:

- **Actions.** REAPER makes extensive use of keyboard shortcuts. In addition, it has a library of hundreds of actions that you won't find on any of its menus, actions which can help you with any number of tasks. Moreover, you can string whole sequences of these actions together to make your own custom commands which can then be triggered off by a single keystroke.
- **Mouse Modifiers.** REAPER uses the mouse for plenty of activities, some of which you have already encountered (like moving and copying media items and making time and loop selections), some of which you have not yet encountered (like editing automation envelopes). Some of these you will use a lot, some you will use a little, and some you will only use rarely, if ever. Any of them can be changed.
- **Menus.** Most REAPER menus can be edited to suit your own requirements. You can move to the top the commands most important to you. You can hide the ones you never use. You can even add your own custom actions and commands to these menus!
- **Toolbars.** REAPER's toolbar might not be much to look at, with its lonely collection of just fourteen tools. Did you know, though, that you can add your own tools to it, as well as create your own extra toolbars?

These are the topics that will be covered in this chapter. Spend as much time as you need to get to understand it. It will pay you dividends.

15.2 REAPER Actions Essentials

Before we look inside REAPER's Action List Editor to explore the world of shortcut keys, custom actions, control surface assignments and more, it's worth taking stock of a couple of useful resources that are available to you.

Key bindings and mouse modifiers opens your default web browser with a list of all current keyboard shortcut and mouse modifiers. This list is searchable and may be printed.

Choose the **Action list as HTML** command from REAPER's **Help** menu to open your default web browser with a list of all of REAPER's many available actions, any of which can be assigned to a keyboard shortcut and/or combined with other actions into your own custom actions. This list is also searchable and may be printed.

Before you rush off to print anything, keep in mind also that this information is also contained within the Action List Editor itself, and that this editor is searchable.

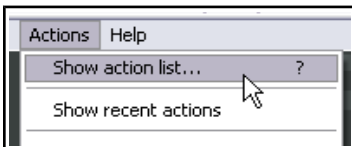

The editor is opened by choosing the **Actions** command from REAPER's main menu, then **Show action list...**, or simply by pressing the **?** Key. Let's take a look inside ...

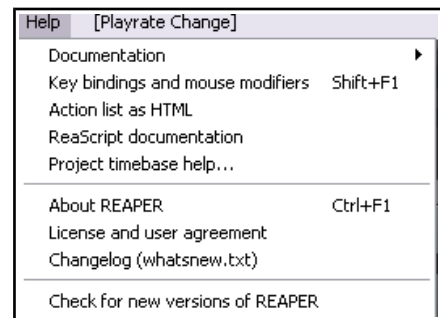

ReaScript documentation. Just what ReaScript is will be explained later in this chapter and in Chapter 24. In brief, ReaScript items can be used to add additional functionality to REAPER. A number of sample scripts can be found at, and downloaded from, stash.reaper.fm/tag/Scripts. They need to be placed inside the Scripts sub-folder within your REAPER applications data directory. They can then be selected and executed within REAPER's Actions list editor by clicking on the **Reascript Load** button.

15.3 The Action List Editor Environment

You'll get more out of REAPER's Action List Editor (shown below) if before trying to use it you take a little time getting to know its interface, its structure and how you can navigate it.

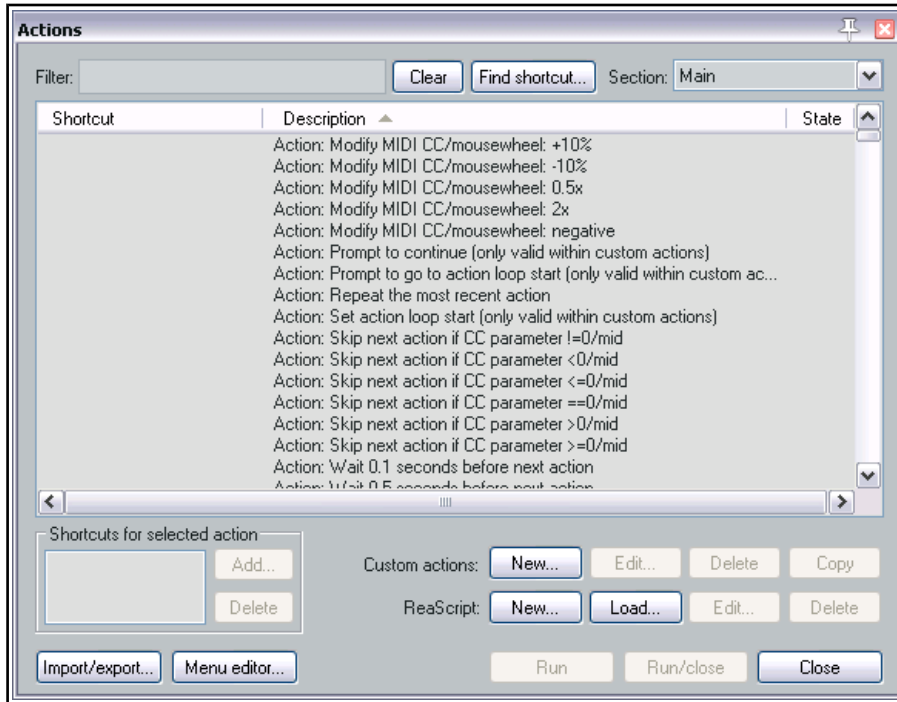

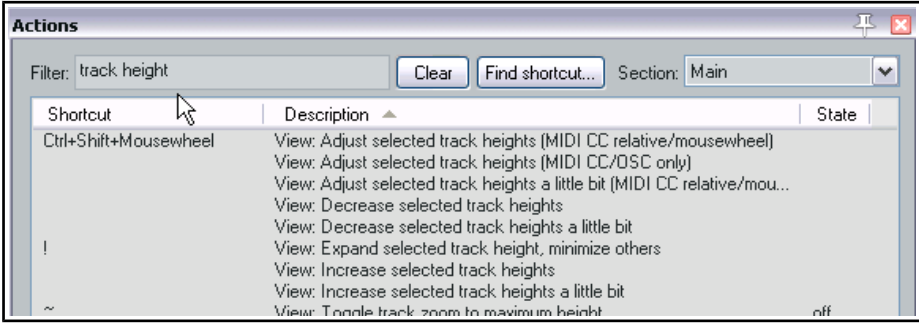
Item	Comments
<p>Filter</p>	<p>You can filter the list of displayed actions using any text string or strings that you like. For example, in this screen shot the list has been filtered to show only those actions that relate to track height:</p>  <p>Boolean search terms are supported. For example, you could search for any of these:</p> <ul style="list-style-type: none"> delete OR remove OR clear insert (item OR media) (spaces before and after parentheses) properties (take NOT channel) (spaces before and after parentheses) <p>Notice that where an existing keyboard shortcut exists it is shown to the left of the action. For example, the ! Key is used to toggle the action View: Expand selected track height, minimize others. Similarly, you can see that Ctrl Shift Mousewheel can be used to adjust the height of any track selection.</p>

15 - Customization: Actions, Mouse Modifiers, Menus and Toolbars

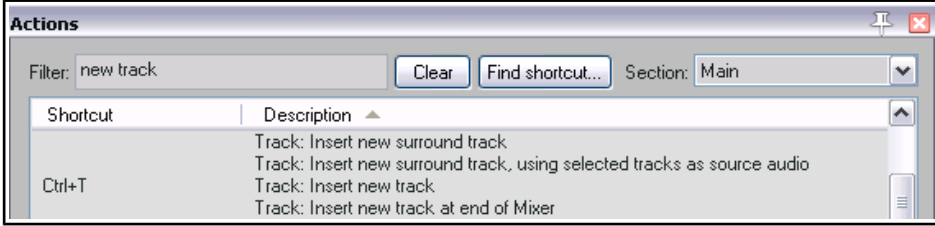
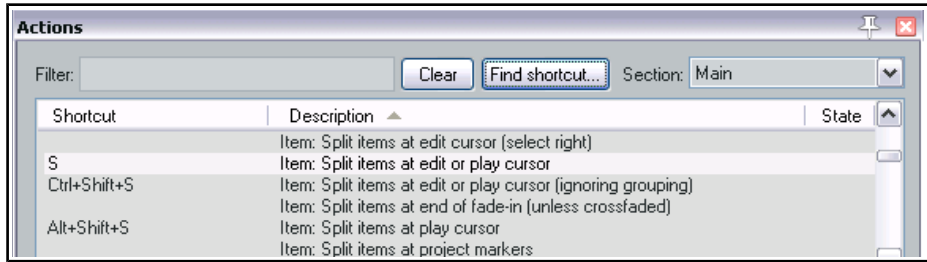
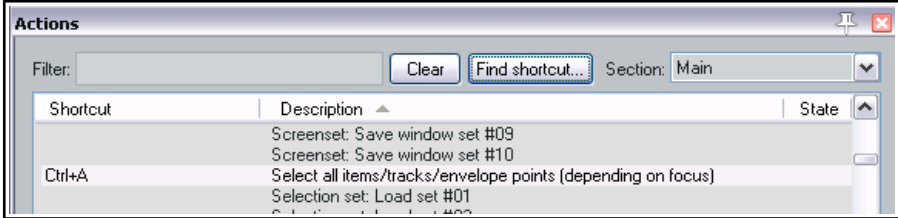
Item	Comments
<p>Filter (cont.)</p>	 <p>In this second example, a filter is used to list all actions relating to new tracks. The only one of these that currently has an assignment is Track: Insert new track. This is assigned by default to Ctrl T.</p>
<p>Clear</p>	<p>The Clear button clears any current filter and restores all actions to the list.</p>
<p>Find shortcut...</p>	<p>The Find shortcut... button is used to see if a particular keyboard shortcut has already been assigned to any action.</p> <p>When you click on this button, you are prompted to type the key or move a MIDI controller. We'll come to MIDI controllers later in this chapter. If the key that you type is already in use, then its assignment will be displayed (see below).</p>  <p>In this example above, we have searched to see if an assignment exists for the letter s. For this kind of search, you should only type in upper case if you really are searching for the combination of Shift with the letter. For example, in this case, a search for Shift S would have produced Item: Split item at time selection.</p> <p>In this second example, we have searched for Ctrl A:</p>  <p>If no shortcut exists for the key or key combination for which you are searching, then a message Shortcut not found will be displayed.</p>
<p>Column headers/ Sort keys</p>	<p>The State column indicates for toggle actions whether their current status is on or off.</p> <p>By default, actions are listed in alphabetical order of their action name. You can click on the Shortcut column header to sort instead on current keyboard assignments. This causes them to be sorted instead by keyboard assignments, with special characters and numbers at the top of the list (see below).</p>

Item	Comments
<p>Column headers/ Sort keys (cont.)</p>	<div data-bbox="451 268 1365 961" data-label="Image"> </div> <p>This can be especially helpful if you wish to familiarise yourself with REAPER's current keyboard shortcut assignments. Click on the column header again to reverse the sort order. Click on Description to sort them back into alphabetical order.</p>
<p>Sections</p>	<p>The Action List is divided into a number of sections, shown here. The Main section is the one that is used most of the time (for example, when you are working in Arrange view). There are different sections, for example, for actions and shortcuts for use with the Media Explorer and the MIDI Editor. If you open the Action List from within one of these environments, the correct Action List section will automatically be selected for you.</p> <p>Otherwise, you can select any section from the drop down list and that section's actions will also be selected and displayed in the action list.</p> <div data-bbox="1047 1121 1377 1367" data-label="Image"> </div>
<p>Run</p>	<p>Any action that is on the action list can be executed from within the action list whether it has a shortcut key assigned or not. Simply select the action, then click on the Run button.</p> <p>If the option Show recent actions is enabled on REAPER's main menu (above) then any actions that you execute in this way during your current work session will be added to REAPER's Action menu and can be executed from there for the rest of that work session. When you close REAPER, these actions will be cleared from the menu.</p> <div data-bbox="829 1524 1380 1646" data-label="Image"> </div>
<p>Run/Close</p>	<p>This button is similar to the Run button, the main difference being that after running the selected action it closes the Actions window.</p>

15 - Customization: Actions, Mouse Modifiers, Menus and Toolbars

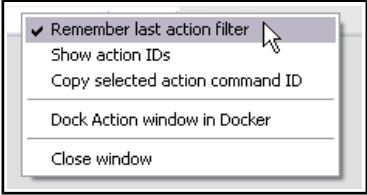
Item	Comments
Close	This closes the Actions window.
Remember last action filter	If this option is enabled (from the Action window right-click context menu) then REAPER will remember your most recent filter and apply it next time the Actions window is opened, even in a future work session. 
Show action IDs	This toggle option (from the right-click context menu) shows/hides a column displaying REAPER's action IDs.
General	The Action window exhibits the basic characteristics of other REAPER windows. For example, you can use the pin symbol (top right) to keep it on top, or you can dock it in the docker (from the right-click context menu).

You'll have noticed several other features inside this window, including a number of additional buttons, some of which are currently dimmed. We'll get to these in due course.

15.4 Creating a New Keyboard Shortcut

In this next example, we will create a new shortcut. Let's take the example of the docker. Filter the action list on "attach" and you will see that **View: Attach/unattach Docker to/from main window** does not yet have any shortcut key assigned to it. Likewise, if you use the **Find shortcut ...** button to search for lower case **Q**, you should find that this letter does not have any action currently assigned to it.

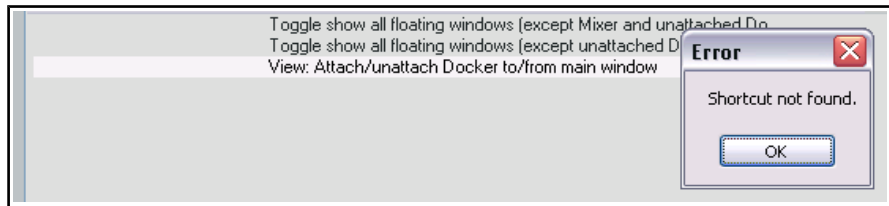

Incidentally, REAPER will not let you accidentally override an existing keyboard assignment. If you try to use a key that is already assigned elsewhere, you will see a message similar to that shown here (right). Trying to assign lower case **U** to an action would produce the message shown here. You would then have the option as to whether to change the assignment for this key or leave it as it is.

Incidentally, REAPER will not let you accidentally override an existing keyboard assignment. If you try to use a key that is already assigned elsewhere, you will see a message similar to that shown here (right). Trying to assign lower case **U** to an action would produce the message shown here. You would then have the option as to whether to change the assignment for this key or leave it as it is.

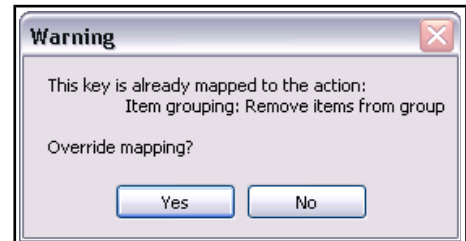

Example

1. From the **Actions** menu, open the **Actions** window (**Show action list ...**)
2. Let's see if we can use **Q** for docking. Click in the **Find shortcut ...** window. Type lower case **Q** and observe the response. You should see a message **Shortcut not found**. We therefore know that this keystroke combination is available. Click on **OK** to close this message box.
3. In the **Filter** box type **attach** then select from the list of actions **View: Attach/unattach Docker to/from main window**.
4. Click on the **Add** button to open the **Keyboard or MIDI Input** box (shown above). When it appears, untick the option **Automatically close window on key/MIDI input**. This makes it less likely that you will assign a wrong key by mistake.
5. Press lower case **q** – you will see **Q** displayed in the **Keyboard or MIDI Input** box (see above).

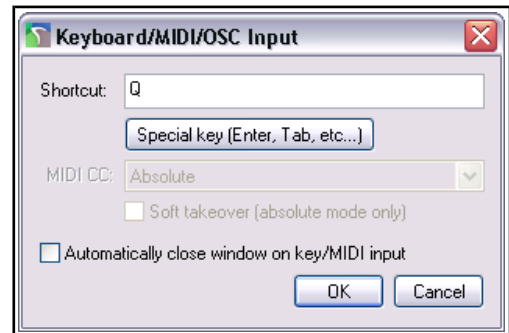

Up and Running: A REAPER User Guide v 5.24

6. Click on **OK**. You can see that this keyboard shortcut has now been assigned.
7. Close the **Actions** window.
8. You can now use the shortcut key lower case D to attach/detach the docker to/from the main window.

15.5 Removing an Existing Shortcut

Removing an existing shortcut is easy. For example, you might like to remove the shortcut that you just assigned to the action **View: Attach/unattach Docker to/from main window**. Follow this sequence:

1. In the Action List, find and select the action from which you wish to remove the shortcut. The current shortcut(s) will be displayed just below the list. (see right).
2. Click on the shortcut shown in the window (in this example, the letter Q).
3. Click on the **Delete** button. The shortcut will be deleted.

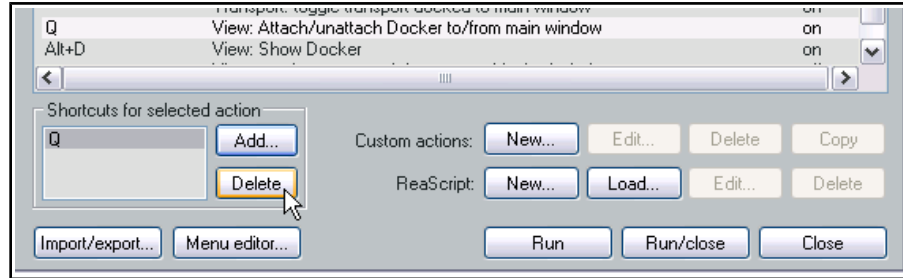

15.6 Changing an Existing Key Assignment

The procedure for changing an existing key assignment combines the two techniques of creating a new shortcut and removing an existing one. Let's take as an example assigning the **Up** and **Down** arrow keys to the actions **Track: Go to previous track** and **Track: Go to next track**, instead of **Ctrl Alt Up** and **Ctrl Alt Down** (the default assignments).

1. Find and select the action **Track: Go to previous track**.
2. In the displayed list of shortcuts, select **Ctrl Alt Up** (see right).
3. Click on **Delete** to delete this shortcut.
4. Click on **Add...** to display the **Keyboard or MIDI Input** window.
5. Press the **Up** arrow (see right), then click on **OK**.
6. When asked if you wish to override the current assignment to **View: Zoom in horizontal**, choose **OK**. You will still be able to use the Plus key to zoom in horizontal.
7. Use the same techniques as at steps as at steps 1. to 6. to change the shortcut key for **Track: Go to next track** from **Ctrl Alt Down** to just **Down**.

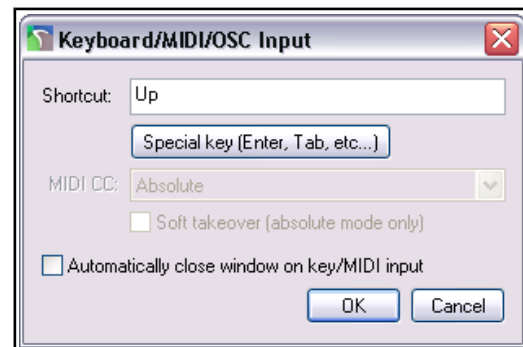
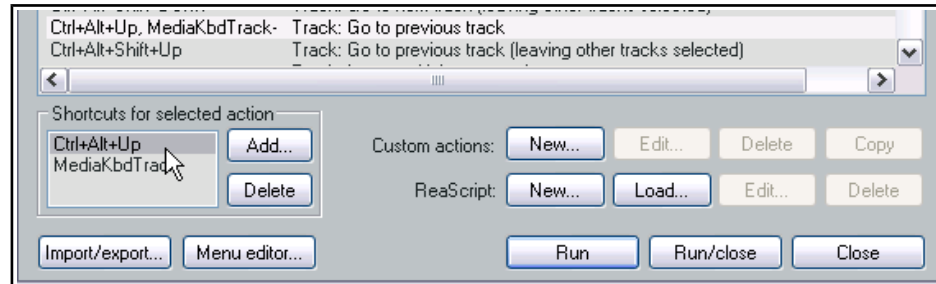

15.7 Deprecated Actions

As you explore the Actions List you might notice that some actions are flagged as "deprecated." This means that these actions are considered no longer suitable and are not supported. It is recommended that you do not use them. The main reason they remain in the Actions List is so that existing custom action macros which use these actions will not be broken.

15.8 Examples of Possible Simple Keystroke Assignments

Many power users believe that keyboard shortcuts are the fastest, most efficient and most productive way of working with REAPER. This is especially the case for frequently repeated activities that might otherwise involve a lot of time fiddling around with the mouse. Keyboard Shortcuts are an extremely important feature of REAPER. As you work your way thru this User Guide, and as you get to know REAPER better, you will find that there are all sorts of actions that you can assign to keyboard shortcuts, *including hundreds that do not appear on any menus*.

Here are some examples of some tasks for which you might consider it worth assigning shortcut keys in the Main section, together with suggested keys that you may wish to use.

Task	Possible Shortcut Key
Track: Toggle bypass FX for currently selected track(s)	B
Track: Toggle bypass FX for all tracks	Ctrl B
Track: View FX chain for current track	Ctrl F
Track: View routing for current track	I
Track: View envelopes for current track	K

15.9 Keyboard Shortcuts for Recording

REAPER makes extensive use of keyboard shortcuts in many, many areas. In this section you will be introduced to how you can create your own keyboard shortcuts to make your recording sessions flow more smoothly. Here is a simple example in which you will create two keyboard shortcuts specifically for use when you are recording. As you become more experienced, you may well find further examples that you will wish to explore.

You will have noticed that when you stop recording, REAPER by default prompts you to confirm whether you want to save or delete the new media items. The Main (alt recording) section of the Action List gives you the opportunity to bypass this prompt by assigning keyboard shortcuts for those options that you use most often – **Save All** and **Delete All**. As with the earlier examples, it is only an example. You'll probably find the exercise worth completing even if you don't want to keep these keyboard shortcuts assignments.

1. In the Actions List Editor, select the section **Main (alt recording)** – see right.
2. In the filter box type **stop save**. You should see the action **Transport Stop (save all recorded media)**
3. Select this action.
4. Click on **Add ...** and type lower case **S** then click on **OK**.
5. Clear the filter box, then type in it: **stop del**
6. Select the action **Transport: Stop (DELETE all recorded media)**.
7. Click on the **Add** button then type lower case **D** to assign this shortcut to the letter D. Click on **OK**.
8. Clear the filter box again.
9. Close the **Actions** window.
10. Make sure that the option to **Use alternate keyboard section when recording** is enabled. You'll find this under **Options, Preferences, General, Keyboard**.
11. Click on **OK** to close the Preferences window.

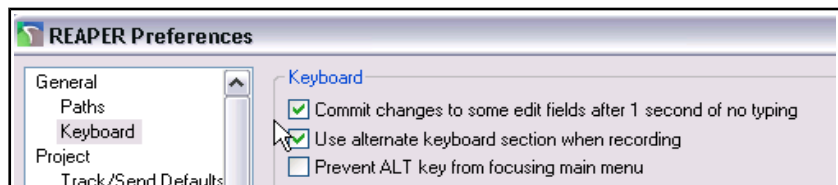
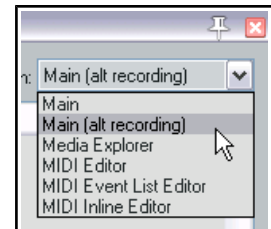

Up and Running: A REAPER User Guide v 5.24

From now on whenever you are recording, you will have the option of using the shortcut keys **S** or **D** to stop recording, automatically saving or deleting the newly recorded media items. You can still use **Enter** if you wish to be prompted. Remember too that when you are not recording, the keys **S** and **D** will revert to their normal functions. For example, **S** can still be used to split media items when working in arrange view.

Tip: If you wish, you can assign macros such as these to an external device such as a keyboard pedal. We'll look at this when we look at Using a Control Device with REAPER.

15.10 Keyboard Shortcuts for the MIDI Editor

Editing is one area where assigning actions to shortcuts can be especially useful, and nowhere more so than when you are using the MIDI Editor. Take the trouble to familiarise yourself with the contents of the MIDI Editor section of the Action List and you should be well rewarded. Notice also that there are separate sections for the MIDI Event List Editor and the MIDI Inline Editor.

The method used for assigning shortcuts to actions, changing or removing existing assignments, etc. is exactly the same as that used in the Main section. For that reason, this section of the User Guide does not contain any step by step examples.

However, below are listed some examples of some actions that you might find useful when working in the MIDI Editor. Special thanks go to Susan G for compiling these lists.

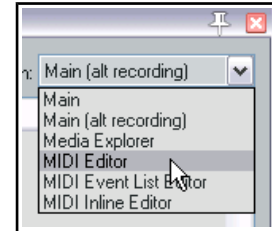

To do this

Managing Notes

Insert notes of a specific length
Make notes legato
Transpose notes
Adjust note lengths slightly
Adjust velocities
Display only notes matching specified criteria

Use an action such as ...

Insert note [range from 1/128 to 1/2 to whole note]
Set note ends to start of next note
Edit: Move notes up/down one octave/semitone
Edit: Lengthen/Shorten notes one grid unit/pixel
Edit: Note velocity +/-01, 10
Filter: Toggle filter on/off

Channels Management

Specify a channel for new notes and events
Show all or specified channels
Change the channel for selected notes

Action: Set channel for new events to 01 ...1 6
Channel: Show all/only/toggle channels 01 ... 16
Edit: Set notes to channel 01 ... 16

Cursor/Grid Management

Advance the cursor by a note value
Move the cursor by specific amount
Change the grid divisions

Cursor: advance ... [range from 1/128 ... to whole note]
Edit: Move edit cursor right/left by grid/measure/pixel
Grid: Multiply grid size by... or Grid: Set division to...

15.11 Keyboard Shortcuts for the Media Explorer

If you work extensively with imported samples and so on, you should definitely take the time to get to know the range of actions available within the media explorer. By now you should be developing enough confidence to explore this for yourself, but to help you here is a summary of some of the most useful groups of actions you will find there:

Browser actions: these are used to navigate your folders. For example, by default **Backspace** will take you to the parent folder (relative to the current folder).

Preview actions: actions exist for a host of tasks, including play, pause, stop, toggle repeat on/off, rewind a little, fast forward a little, stop preview when inserting media, and many more.

Tempo match actions. These include tempo match off, tempo match on, toggle on/off, and tempo match/2.

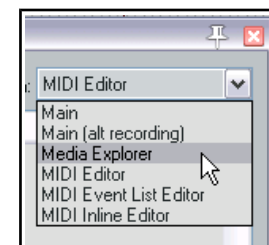

15 - Customization: Actions, Mouse Modifiers, Menus and Toolbars

15.12 Assigning Actions to the Mousewheel

One special type of action assignment that you can make is to the mousewheel, optionally also using modifier keys. This way you are able to change the REAPER default mousewheel assignments. This can be useful, for example, if you wish the default behavior of the mousewheel to be to scroll rather than to zoom. Here's a reminder of the default mousewheel assignments:

Mousewheel alone	View: Zoom horizontally
with Ctrl	View: Zoom vertically
with Alt	View: Scroll horizontally
with Ctrl+Alt	View: Scroll vertically
with Ctrl+Shift	View: Adjust selected track heights

Again, the method for changing these is essentially the same as that which you have already used. Suppose, for example, that you wish to use the mousewheel by itself to scroll horizontally.

1. In the action list (Main section), find the action **View: Scroll horizontally**.
2. In the shortcuts list, select **Alt + Mousewheel** and click on **delete**.
3. Click on the **Add** button, then scroll the mousewheel. The text Mousewheel will be displayed, as shown on the right.
4. Click on **OK**.
5. If you wished, you could now use the same method to assign **Alt + Mousewheel** to the action **View: Zoom Horizontally**.

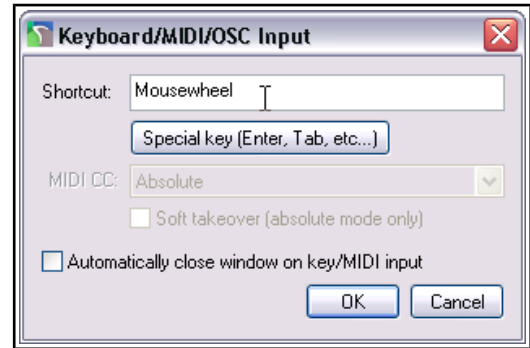

15.13 Exporting and Importing Keyboard Shortcuts

The **Import/export** button near the bottom left corner of the Actions window can be used to backup or restore any or all of your keyboard assignments. Exported keymap sets are by default saved as .ReaperKeyMap files in the \KeyMaps directory of your \Application Data\REAPER folder.

This feature can also be used to copy keyboard assignments from one computer to another. The options on the menu are for the most part quite self-explanatory:

Import ... Imports keyboard assignments from an existing .ReaperKeyMap file.

Export all ... Exports all your current keyboard shortcut assignments to a .ReaperKeyMap file.

Export selected items ... Exports only those items currently selected to a .ReaperKeyMap file.

Restore all shortcut binding to factory defaults Removes your custom keyboard assignments and restores all REAPER defaults.

.ReaperKeyMap files can also be included when exporting/importing configuration settings (see Chapter 22).

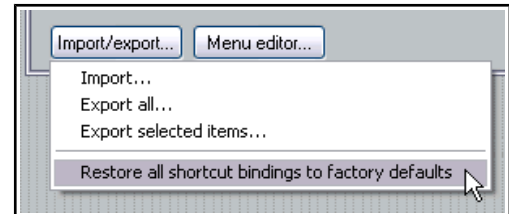

15.14 Creating Custom Action Macros

You can assign an entire sequence of actions to a single keyboard shortcut if you wish. In fact, there is no preset limit to the number of actions that you can assign to a single keystroke or keystroke combination. The process of assigning more than one action to a keystroke is known as creating a custom action, or macro.

As you browse the actions list, you might at first be somewhat puzzled at some of the items that are there. You might wonder, for example, why would anybody need an action for **Item: Select item under mouse cursor** when it is surely easier just to click on the item.

Often with actions like this, the answer is that the real power of these actions comes not from using them on their own, but in combination with other actions.

Managing Custom Actions (Macros) – Summary Table	
In order to do this ...	You do this ...
Create a new macro	Click on New... button. Type a name for your macro.
Add actions to a macro	Drag and drop from action list, or double-click.
Change order of actions	Drag and drop up or down the list.
Remove action from macro	Select action in macro action list, click on Remove .
Add macro to main Actions menu	Enable the option Show in actions menu .
Consolidate macro into a single undo point	Enable the option Consolidate undo points .
Save macro	Click on OK .
Assign shortcut key to a macro	Select the macro in the Action List. Click on Add .
Edit an existing macro	Select the macro in the Action List. Click on Edit .
Copy an existing macro	Select the macro in the Action List. Click on Copy .
Run an existing macro	Use shortcut key (if assigned), or select the macro from REAPER's Actions menu (if this option is enabled), or select macro in Action List and click on Run option.
Delete an existing macro	Select the macro in the Action List. Click on Delete .

Let's take a simple example. Normally, to split an item you would need to select the item, position the edit cursor at the required position, and then press S to split it. By creating a custom action, we can combine this sequence of activities into a single keystroke.

Example

- In the Actions List Editor, click on the **New** button. This will cause the **Create Custom Action** window to open (see right). Type a name, such as **Split under mouse**.
- In the list of actions shown in the left panel. Find the action **View: Move edit cursor to mouse cursor**. Double-click on this action.
- In the list of actions shown in the left panel. Find the action **Item: Select item under mouse cursor**. Double-click on this action.
- In the list of actions shown in the left panel. Find the action **Item: Split items at edit or play cursor**. Double-click on this action.

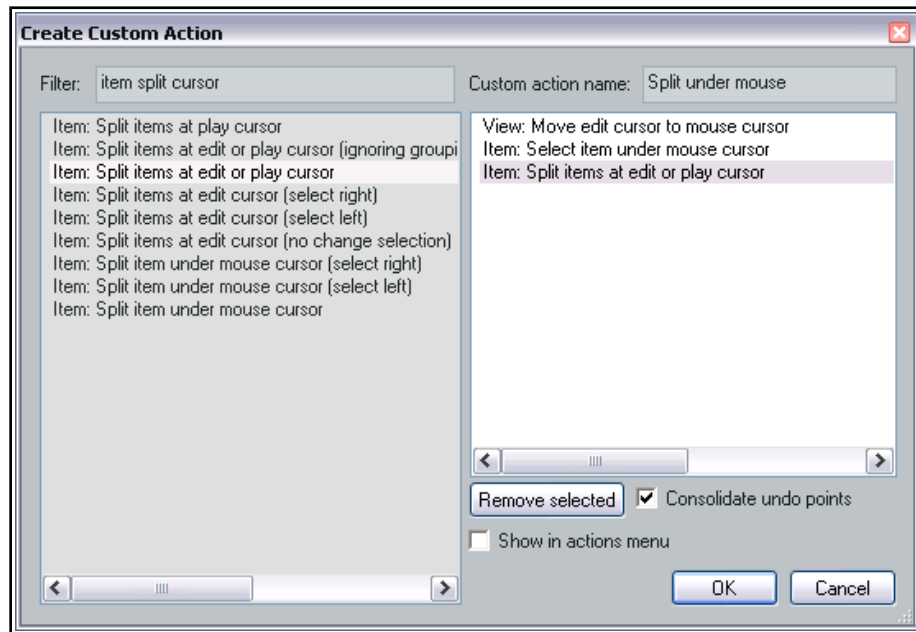

15 - Customization: Actions, Mouse Modifiers, Menus and Toolbars

5. Click on the option **Consolidate undo points** to enable this option.
6. Click on **OK**. You will be returned to the main Action List with your new custom action selected.
7. Click on **Add** and type lower case **C** to assign this keystroke to your macro. Click **OK**.
8. **Close** the Actions List Editor.
9. Hover your mouse over any media item and press lower case **C**. The item will be split at that point. One of the split items will still be selected. If you don't like this, you can edit the macro.
10. Open the Actions List Editor, find your macro **Split under mouse** and select it. Click on **Edit**. Add to the end of this macro the action **Item: Unselect all items**. Click on **OK**.
11. Now test the macro again. This time it will split items without leaving anything selected.

This is of course just one example of a custom action macro in action. Think about those sequences of actions and commands that you use together a lot ... think actions, think macros! You'll also find plenty of ideas and inspiration on **The Useful Macro Thread** on REAPER's **Q&A, Tips, Tricks and How To** forum – at forum.cockos.com.

15.15 MIDI Editor Custom Macros

If you use the MIDI Editor a lot, then you should find that this is a good area in which to be looking for macros which will speed up your editing and make it simpler. The examples below were supplied by Bevosss. They show that a macro doesn't have to be lengthy and complicated to be useful

This custom action does this
Navigate: select next note right with same note value Navigate: move edit cursor to start of selection	This will find the next note with the same value as the current one, select it, and move the edit cursor there.
Navigate: select previous note right with same note value Navigate: move edit cursor to start of selection	This will find the previous note with the same value as the current one, select it, and move the edit cursor there.
Edit: Select all Remove selected duplicate events Edit: Unselect all	This macro removes all duplicate events from the current item.
Grid: Set grid division to 1 Edit: Insert note at edit cursor Edit: Unselect all	Creates and inserts a semibreve (or whole note). The note duration sets the grid. Thus, you could have equivalent actions for any other fraction of a note or multiple of a note available in the actions list.

15.16 Importing Scripts

For more advanced custom programs which go beyond chaining together actions, you can import into REAPER custom scripts that you may have written or obtained and which add extra functionality to the program.

Python, EEL and Lua scripts can all be imported. For Windows users, if you are to access actions written in Python, then it will need to have been installed on your computer and ReaScript enabled on the Plug-ins, ReaScript page of your Preferences. Otherwise, these Action List controls may be dimmed.

The topic of writing scripts is outside the scope of this User Guide, although there is a brief introduction to ReaScript in Chapter 24. If you are interested in learning more you should visit the REAPER web site, and in particular: www.cockos.com/reaper/sdk/reascript/reascript.php

ReaScript Documentation can also be opened from REAPER's Help, HTML Lists command.

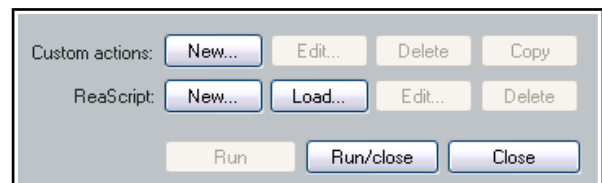

15.17 Using a Control Device with REAPER

A control surface such as a Behringer BCR2000 or a Novation Nocturn can be used to control some of REAPER's actions. You might also be able to use your pedals and other controls on a MIDI keyboard in a similar way.

Examples might include track panning and volume, mute and solo status, arming and starting/stopping recording, and possibly to physically map REAPER's transport bar for functions such as Play, Stop, Pause, Rewind, etc. Of course, you will need to know the specific characteristics of your particular device, including how to install it, set it up and so on. That is obviously outside the scope of this User Guide.

You should also be aware that different control devices have different capabilities and different applications. Not all control surfaces can be used to control all actions, even those that are listed as midi CC capable. Obviously it is also beyond the scope of this user guide to present a detailed analysis and comparison of all these. In overview, however, they fall into two broad categories:

- Devices which can be recognised by REAPER as a specific and individually named control surface.
- Generic devices not specifically recognised but which can nonetheless be used as a control surface.

If you have a control device of a type listed in the illustration here, first make yourself familiar with its documentation. Next, install the device and its drivers on to your computer in accordance with the manufacturer's instructions. You should then be able to select it on the **Control Surfaces** page of REAPER's Options Preferences settings. Of course, you should consult the manufacturer's documentation and/or web site for further information. You may also be able to find further information on one of REAPER's on-line forums.

Choose the **Options.**

Preferences command, then select **Control Surfaces** and click on **Add** to see a list of available devices (see right).

Notice that the list includes an entry for devices which conform to the **OSC (Open Sound Control)** protocol. If you are intending to work with such a device, be sure to familiarise yourself with its documentation and characteristics before proceeding.

If you choose this option from the list, the screen that then follows will give you the opportunity to specify a device name and pattern configuration. This

includes choices such as LogicTouch or LogicPad, or to tell REAPER to write a sample (default) configuration file. This file will contain the default mappings and various appropriate comments. You should also supply a port number (for the transfer of messages) and IP addresses for both the host and the device itself. Go to <http://www.cockos.com/reaper/sdk/osc/osc.php> to learn more about how REAPER handles OSC and about REAPER's Default.ReaperOSC file.

For other (non OSC) control devices, even if they are not shown on this list, you might still be able to install and use them if they are capable of emulating one of the devices that is listed (e.g. HUI or Mackie emulation). You should check the manufacturer's documentation and web sites.

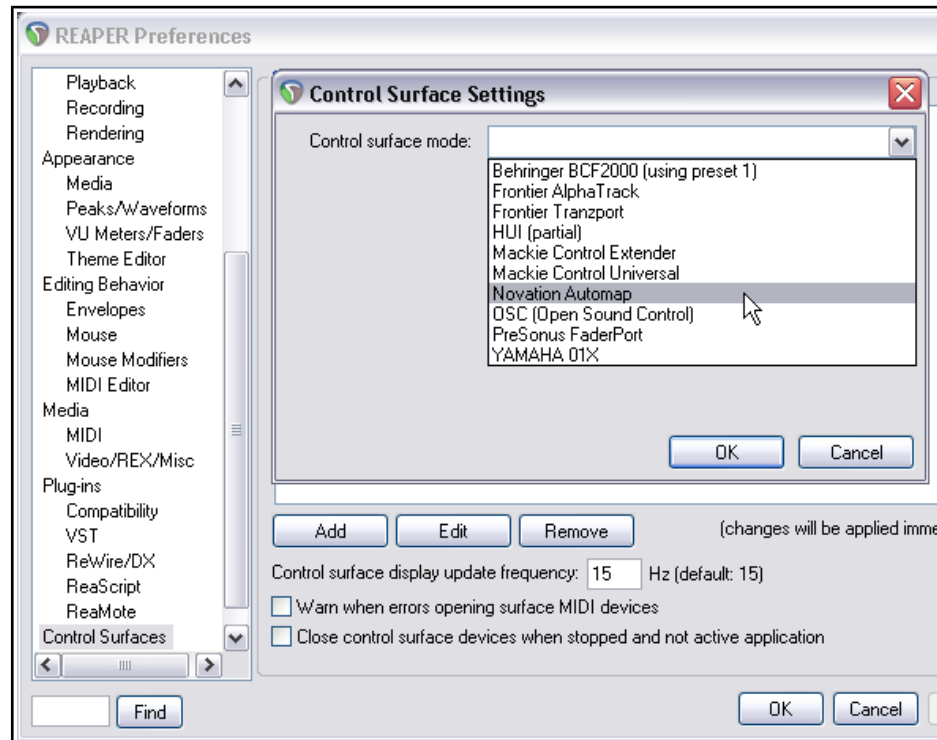

15 - Customization: Actions, Mouse Modifiers, Menus and Toolbars

In every case, make sure that you choose the options that are correct for your device from the various **Control Surface Settings** options. Shown below is one example of such settings, with a Novation Nocturn. This sample screen is not intended as a model for you to use with any particular product.

You might wish to install several devices in this way. For example, you might wish to use both a Frontier AlphaTrack and a Frontier Tranzport. This is perfectly possible, so long as each device is installed correctly.

You will need to consult the product documentation to ascertain how then your control surface(s) can be used with REAPER.

If your device is not on the list of recognised control surfaces and cannot emulate any of the items on that list, you can still use it with REAPER. An example of such a product is the Behringer BCR2000. Once it has been physically set up and installed on your computer, it will appear on the list of REAPER's MIDI Devices. Depending on the actual product and which drivers you are using, it might appear on this list with its own name or merely as a **USB Audio Device**.

Install it as a MIDI Device, most likely Input Only and in most cases for control messages only. An example of this is shown here. You can double-click on the device name to open the **Configure MIDI Input** dialog box. What you do next will depend on the device. You might also use this method to use your MIDI keyboard also as a MIDI controller (depending on whether the keyboard supports this feature).

Once such a device is installed, you can then assign any action listed as supporting midi CC control to one of the knobs, faders, buttons or rotaries on your control device.

The procedure is similar to assigning an action to a key on your PC keyboard. Open the **Actions** List from the REAPER menu. Select the action, click on **Add** then instead of pressing a key on the keyboard, tweak the control surface control and click on **OK**.

An example is shown on the right - in this case we are assigning a rotary control to be used to adjust the volume of track 1.

For further information, including about the various settings, you should consult

the documentation supplied with your device, the manufacturer's web site, or one of the REAPER forums.

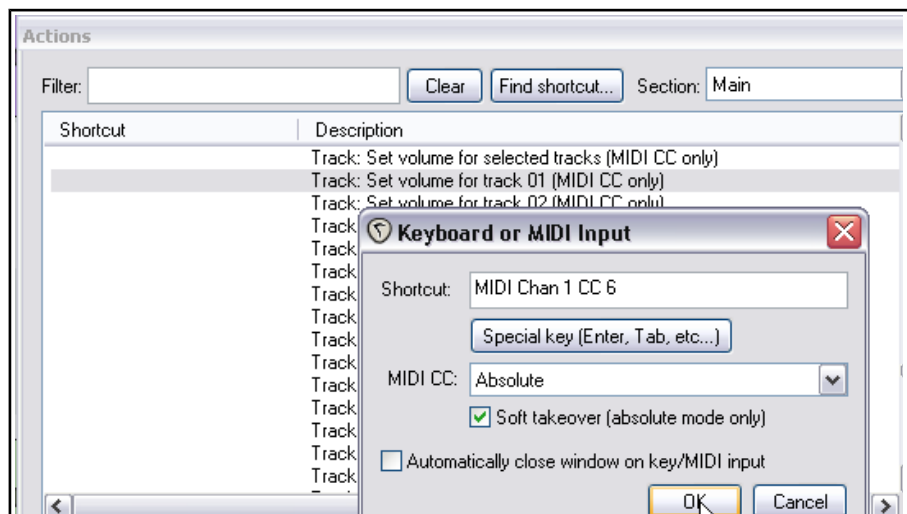
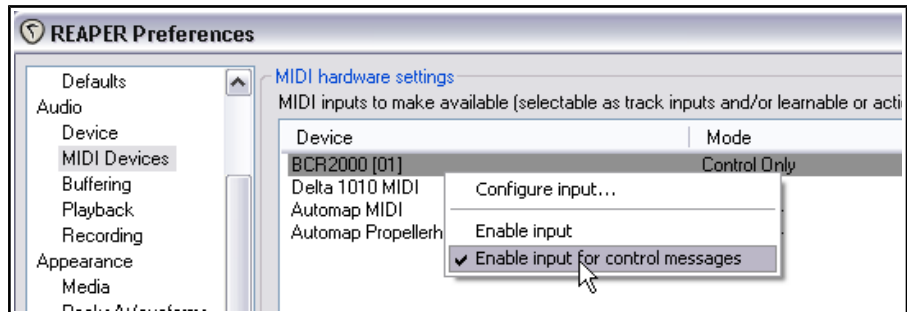
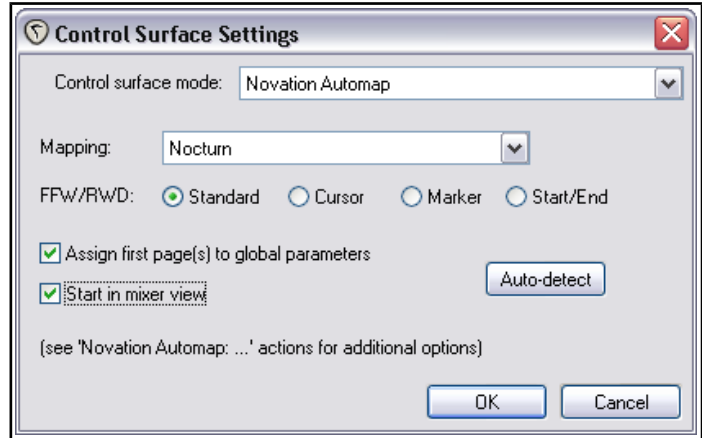

15.18 Meta Actions

Meta actions are special actions that take your custom action macros a step further, for example to be able to repeat the same macro as many times as is required without you having to keep pressing the same shortcut keys. This technique can be useful in an example such as if you need to drop a marker at the start of each verse of a song. When you create the macro you don't know how many times you will need to repeat the actions - some songs might have two or three verses, others five or six. This is a perfect example of when you might wish to use a meta action.

REAPER includes two meta action commands:

- Action: prompt to continue, and
- Action: prompt to go to action loop start

Example

Take a look at the example on the right. If you create this custom action macro and assign it a keyboard shortcut (such as **Ctrl Shift K**), then you can use it in this way.

Select any track which is made up of multiple items and position the play cursor at the start of the timeline.

You can then activate this macro. The cursor will move to the start of the first item in the selected track and drop a marker at that point. You will then be asked if you wish to continue (see illustration below).

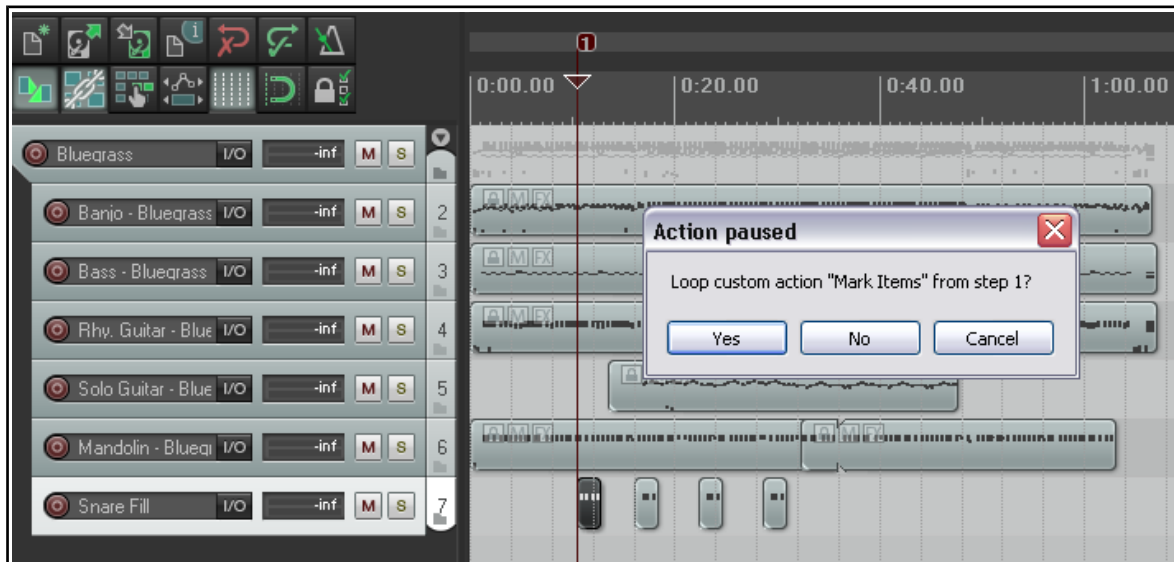
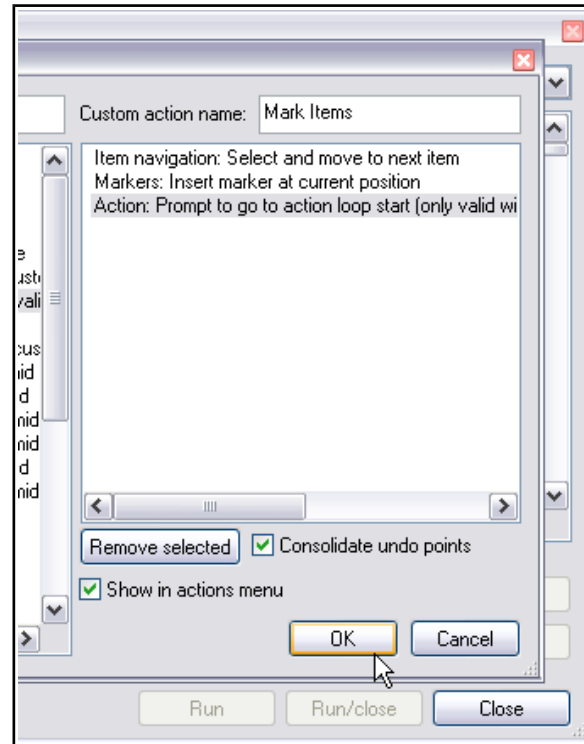

If you press **Enter** or click on **Yes**, the play cursor will move to the start of the next item, insert a marker there, and ask the question again. If you click on **No**, then the execution of the custom action macro will stop.

15 - Customization: Actions, Mouse Modifiers, Menus and Toolbars

15.19 Mouse Modifiers

We've come across the mouse modifiers page of REAPER's preferences settings several times already. You can use this page to change any of REAPER's default mouse modifier controls and also to add more of your own. Some pointers to keep in mind:

- **Modifier keys.** Windows users can use any of the following modifier keys, in any combination, for any mousewheel action: **Shift, Ctrl, Alt, Win**
Mac users may use any of these modifier keys, in any combination: **Shift, Command, Option, Control**
- **Contexts.** The Contexts drop down list on the Mouse Modifiers page of your preferences window lists the contexts in which you could use your mouse and for which you could need modifiers (see right). When you select an item from this list, current mouse assignments for that context are displayed.

For most contexts you will find a number of variations, depending upon the exact kind of mouse action being undertaken. For example, separate mouse modifiers can be applied to media items depending on whether the mouse action being applied is a simple left click (which by default selects the item), left drag (which by default moves the item) or a double-click (which by default opens MIDI items in the MIDI editor, or displays media item properties for audio items). Some contexts (e.g. Arrange view) also make middle button mouse actions available.

You aren't going to learn all of these at once, and some of them you may never need. For example, if you never do any work with MIDI then the various MIDI contexts are unlikely to be important to you. Take the time to identify those which you are likely to use the most and think about how you can improve them. The procedure for customizing REAPER's mouse modifiers is as follows:

1. Display the **Mouse Modifiers** page of REAPER's Preferences Window.
2. Display the Context drop down list and select an entry from that list. A list of current modifiers for that context is then shown. An example of this is shown here, for **Media item edge left drag**.

3. In the Modifier column, double click on the item that you wish to change. A list will be displayed which shows *suggested* actions that you might wish to assign to that modifier. You now have a number of choices:

- ✓ Select any item from that list, or
- ✓ Select No Action to disable that modifier, or
- ✓ Select the item marked with a bullet to restore REAPER's default action for that modifier, or
- ✓ For some items only (including double-click items), use **Action List ...** to open the Action List editor so that you can assign one of REAPER's actions, or one of your own custom actions, to that context.

4. Click on **Apply** to apply your changes.
5. Repeat steps 1. to 4. as often as needed. When finished, click on **OK** to close the Preferences window.

If you get into trouble, use the the **Import/Export** button then **Restore modifiers to factory defaults in this context**. This will restore REAPER's original modifiers to this context.

The examples that follow have been selected to help you to understand how REAPER's mouse modifiers work and how you can benefit from using them. Don't be concerned if not all of the actual examples themselves mean a lot to you right now: try to stay focused on the technique. Let's suppose that there are certain editing

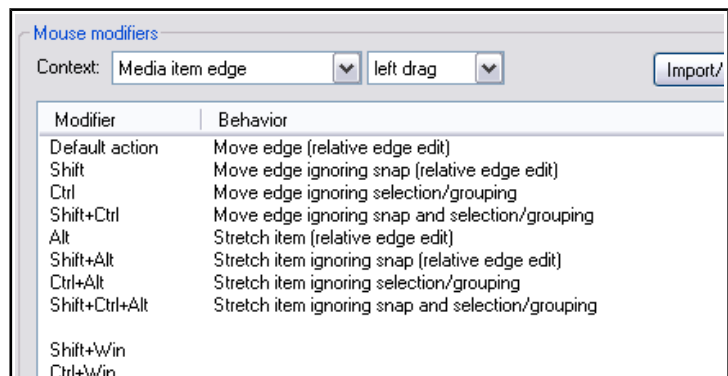
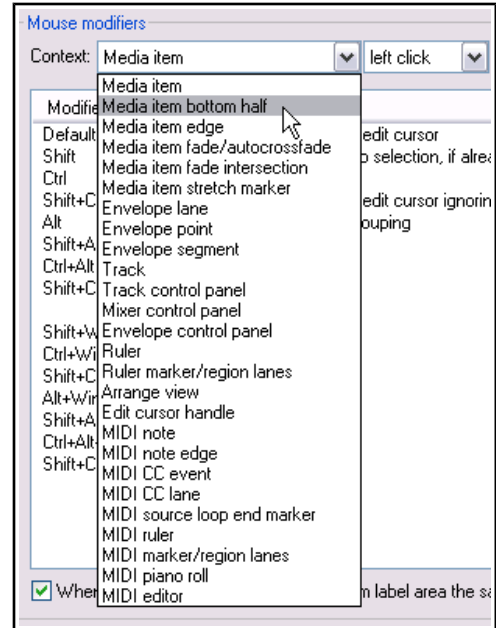

Up and Running: A REAPER User Guide v 5.24

and other activities that you use a lot in REAPER. Let's also suppose that these include the following:

- Creating empty MIDI items on tracks.
- Slipping editing media items.
- Adding FX to media items.
- Toggling mute status of media items.
- Setting and removing loop points.

That's (intentionally) a fairly mixed bag of activities. All of these are examples of activities that can be made easier and/or faster and/or smarter by modifying REAPER's mouse modifiers.

Examples

This exercise will step you thru the above examples in the same order as they are listed.

1. Choose the **Options, Preferences** command, then select the page **Mouse Modifiers**.
2. Select **Track left drag** from the context menu. REAPER's default mouse assignments for pencil drawing copies of items will be shown. Notice that **Alt** and **Shift Alt** are currently unassigned.
3. Double click on the word **Alt** in the Modifier column. A list of possible suggested actions will be shown.
4. In this list, click on **Draw an empty MIDI item**. This action is now assigned. The small dot shown next to this Action on the list indicates that this is a custom change that you have made yourself.
5. Click on **Apply** to apply the action.
6. Now select **Media item edge drag** from the context list. Let's suppose that we want to make **Move item edge ignoring snap** the new default behavior when clicking and dragging from the media item edge.
7. Double click on **Default action** and select **Move item edge ignoring snap** from the menu. Now double click on the modifier **Shift** and select **Move item edge** from the menu.
8. Click on **Apply**. These two items have now been swapped over.
9. Now select **Media item double-click** from the context drop down list. Modifiers for this context will now be displayed. Suppose that we want to create an action which can be used to open the item's FX chain window, and that we wish to assign **Shift Ctrl** for this.
10. Double-click on the text **Shift+Ctrl** to display a menu. Click on **Action List ...** to open the Action List Editor. If you have worked thru the earlier examples in this chapter, this will be familiar! Find the action **Show FX chain for item take** and select it. Click on **Select/Close** to return to the Mouse Modifiers window. Click on **Apply**. This action is now your media Shift Ctrl double-click action (see below).
11. Repeat this procedure to apply the action **Item properties: Toggle items mute** to the modifier **Shift+Win**. Click on **Apply**.
12. Finally, we can add an action to the **Ruler double-click** context so that the **Shift** modifier will remove any current loop points.
13. Select **Ruler double-click** from the context drop down list. Double click on **Shift** in the modifier column and select **Action List...** from the menu. Find the action **Loop Points: Remove loop points**, select it then click on **Select/Close** and then **Apply**.
14. Close the Preferences window.

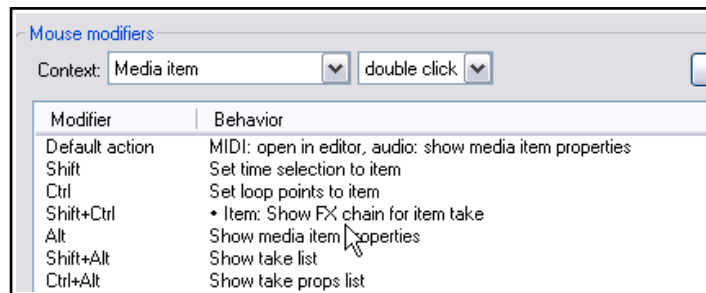
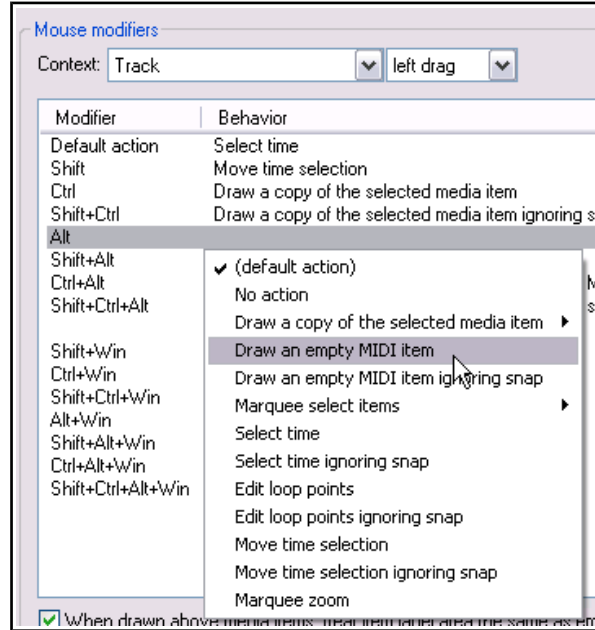

15 - Customization: Actions, Mouse Modifiers, Menus and Toolbars

If you do not wish to keep these assignments, use the **Import/Export** button to restore factory defaults.

Remember! When you are assigning actions to mouse modifier keys you are not limited to using REAPER's native actions. Provided that you have installed the SWS extensions you can use any of the SWS actions. You can also use any custom actions that you have created yourself.

Note: When you select a mouse modifier context, in some cases an option relevant to that specific context will be displayed just below the list of behaviors. Look out for these. For example, for both the Track and Media items contexts you can specify whether the item label area (above the media item) should be regarded as part of the media item or as empty space.

Tip for OS X Users:

Next to the Import/Export button you will find a **Swap cmd/opt** button. This can be used to swap over all **Cmd** button and all **Opt** button assignments for the currently selected mouse modifier context,

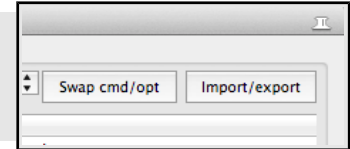

15.20 Saving and Restoring Mouse Modifier Settings

Mouse modifier settings can be saved to and restored (loaded) from REAPER mouse map files using the Import/Export button. Settings can be saved/restored for the current context only, or for all contexts (see right).

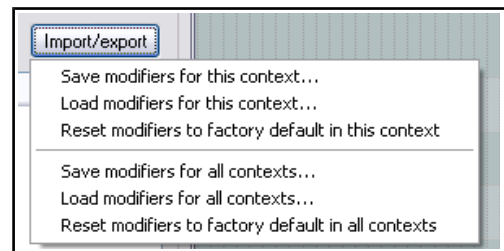

15.21 MIDI Editor Mouse Modifiers

Using mouse modifiers in the MIDI Editor is a topic that merits a section of its own. Nowhere is this more true than when you are editing MIDI notes and CC events.

A large number of actions are available for use in the MIDI editor. One example is the **MIDI note left click** context (below). If you use the MIDI Editor a lot then you should definitely take some time to investigate and to identify which of these actions are most useful to you. For example, you could reassign **Alt** to be used when clicking on any note to erase it. Notice that in addition to the other shown on the menus, you can choose to open the **Action list** and select an action there.

Remember that all actions in REAPER's Action List MIDI Editor and MIDI Event List Editor categories (including any custom actions of your own) are available to be assigned as a mouse modifier in most contexts within the MIDI Editor. MIDI Editor mouse modifier contexts include:

- MIDI note left drag**
- MIDI note double click**
- MIDI note edge left drag**
- MIDI note double click**
- MIDI CC event left drag**
- MIDI CC lane left drag**
- MIDI CC event double-click**
- MIDI CC lane double-click**
- MIDI source loop end marker left drag**
- MIDI ruler left click**
- MIDI ruler left drag**
- MIDI ruler double-click**
- MIDI marker/region lanes left drag**
- MIDI piano roll left drag, MIDI piano roll double-click, and**
- MIDI editor right drag.**

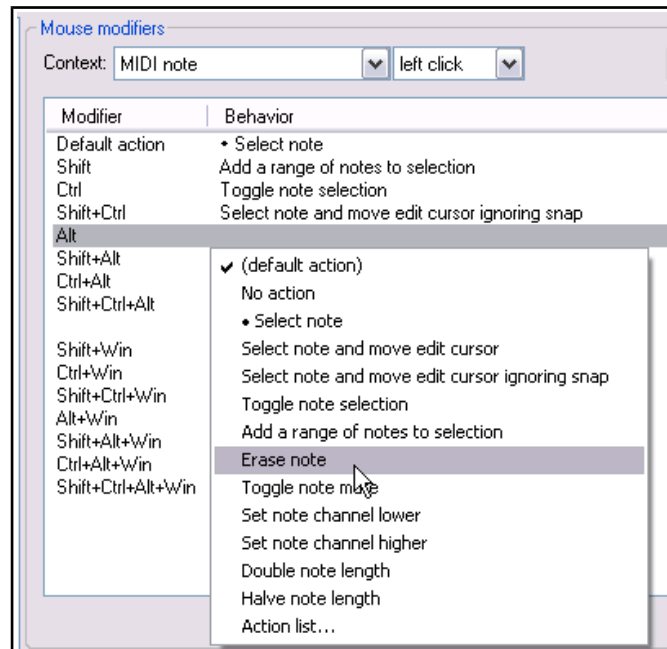

Up and Running: A REAPER User Guide v 5.24

Let's take a brief look at some of these areas in which you can modify mouse behavior within the MIDI Editor. Shown here are the defaults for **MIDI note left drag**, **MIDI piano roll left drag** and **MIDI ruler left drag**. In many cases separate contexts are available for left click, left drag and double-click behavior. You can define how your mouse behaves when it is being used in any of these contexts.

Within most contexts you will find several different types of mouse action. For example, when working with MIDI notes, a different action will be required when (say) dragging a note from when double-clicking on it. Thus, within the Mouse Modifier page of your preferences, you can select not only a context but also a type of mouse action.

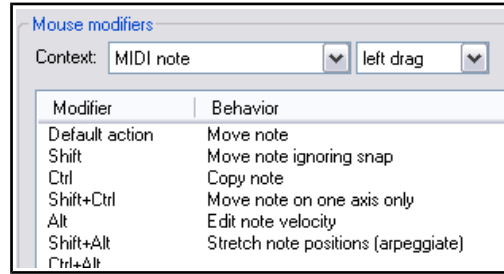

Let's look at just two examples: the default actions for the contexts MIDI note left drag (above right) and MIDI piano roll left drag (right). By default many actions are already defined. For example, simply dragging a MIDI note (or selection of notes) will by default move the note(s), whereas holding Ctrl while you do this will copy them. As you go down the list some of these defaults become quite interesting. For example, holding Shift and Alt while dragging a marquee selection of notes will stretch the selection out horizontally so as to arpeggiate the notes.

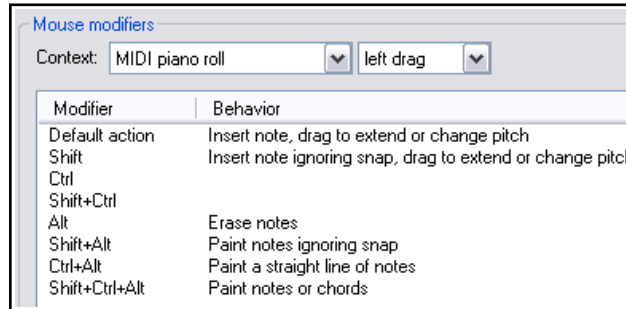

Simple click and drag in the empty MIDI piano roll area will first draw a note, then extend it as the mouse is dragged. Various keys can be used with this for other actions. For example, holding Ctrl and Alt while dragging will paint a straight line of notes between mouse up and mouse down.

Many key combinations are not assigned. Click on any of these for a list of actions that you can use. You can also use this method to change any existing assignments. Shown right are the default actions which are assigned to the **MIDI ruler left drag** context.

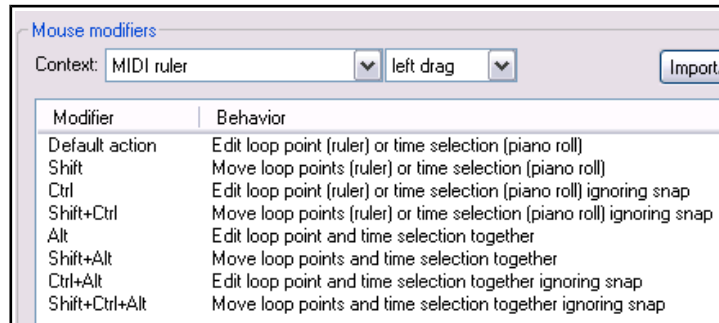

If you use the MIDI Editor a lot, you should take the time to explore just what is available for the different contexts.

Take the time also to look at the **MIDI editor right drag** assignments. As well as several variations to set marquee behavior (select notes, add notes, toggle selection, etc.) there is also an action using **Ctrl Alt** to select all notes touched while freehand dragging.

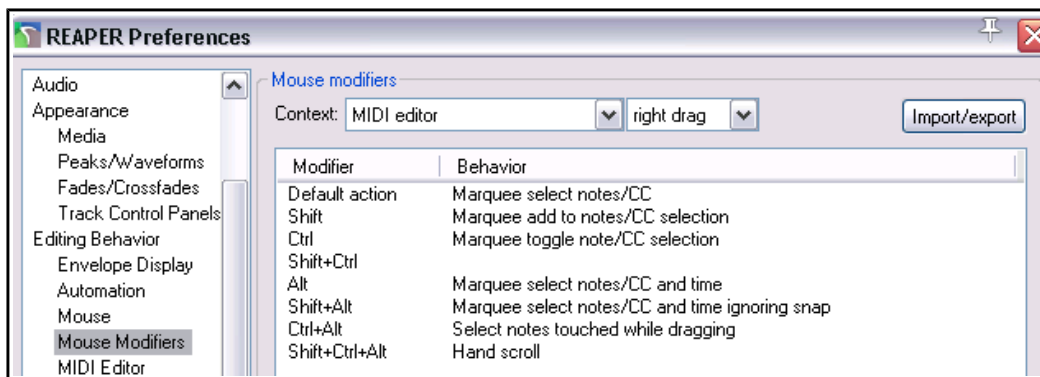

15 - Customization: Actions, Mouse Modifiers, Menus and Toolbars

15.22 Customizing the REAPER Menus

You can customize REAPER's main menu and many context menus in a number of ways, including:

- Removing from view commands that you never use.
- Changing the order in which commands are listed.
- Adding your own custom actions to an existing menu.

To open and display the **Custom Menu** interface, choose from the main menu the command **Options, Customize menus/toolbars**. This causes the Customize menus/toolbar window to be displayed. By default, it will open with the Main File menu displayed.

The table below summarizes the main tasks that can be carried out within this window.

The **&** sign displayed before any letter

indicates that when the menu is displayed, that letter can be typed to select that command. On the menu itself, the letter will appear underscored. Thus, in the example shown above, when you display REAPER's main file menu, the letter **N** in **New project...** will appear underscored, and you can therefore type **N** to select this command.

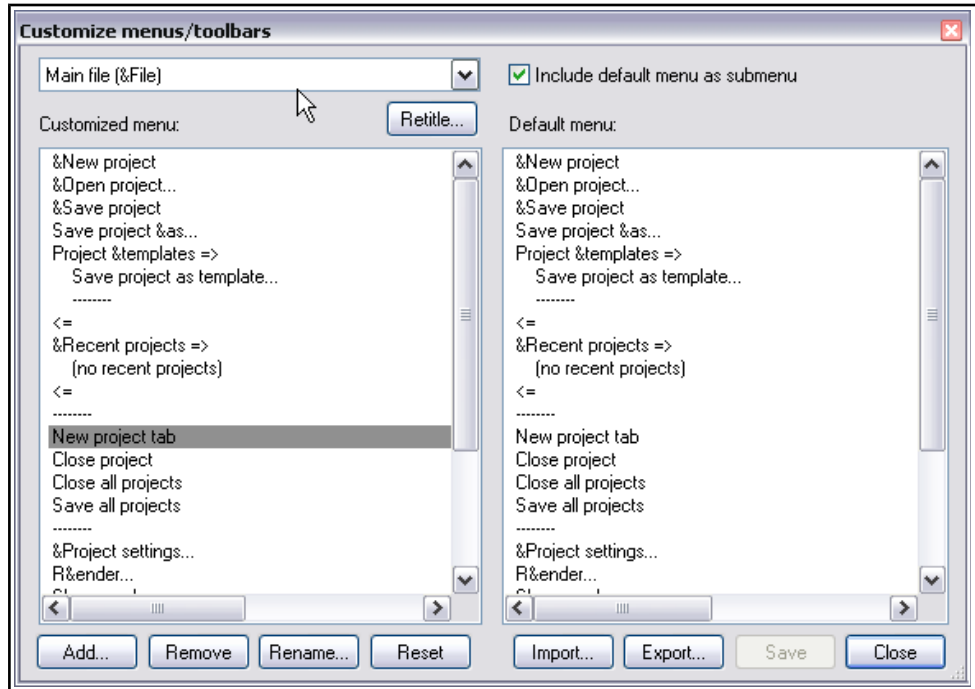

In order to do this you need to do this.
Select a menu for customization	Display the drop down list (top left of window) and select the required menu.
Change the name of a currently selected main menu command	Select the command. Click on the Retitle... button. Type the new name and press Enter
Remove a command from the currently selected custom menu	Select the command in the left hand column (click once). Right-click and choose Remove from the menu, or click on the Remove button located below the customized menu pane.
Change the position of a command on the custom menu	Either ... in the left column, drag and drop the command up or down to its required position. Or ... in the left column select the command that you wish to move. Press Ctrl X . Click at the position where you wish the command to be placed. Press Ctrl V .

Up and Running: A REAPER User Guide v 5.24

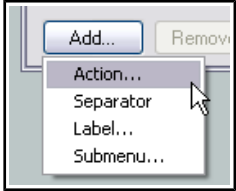
In order to do this you need to do this.
Copy a command from one main level menu to another	Select the first main menu from the menus drop down list. Select the required command and press Ctrl C . Select the second main menu from the menus drop down list. Click at the required position in the customized window (left) pane and press Ctrl V .
Add a REAPER action or a custom action to the current custom menu as a new command	In the left column, click to select the existing command above which you wish to insert your custom action. Click on the Add button, then choose Action from the menu. Select your item from the list then click on the Select button. 
Rename a command on the custom menu	In the left column, select the command, click on Rename , then type the new name and press Enter .
Add a separator to the current custom menu	In the left column, click to select the existing command above which you wish to insert the separator. Click on the Add button, then choose Separator from the menu.
Add a label to the current custom menu	In the left column, click to select the existing command above which you wish to insert the label. Click on the Add button, then choose Label from the menu.
Add a submenu to the current custom menu	In the left column, click at the position you want the submenu inserted. Click the Add button, then on Submenu . Type a name then press Enter .
Save changes made to the current custom menu	Click on the Save button.
Restore the one or all custom menus to the default settings	Click the Reset button, then choose either Reset Current Menu or Reset All Menus .
Export the current custom menu or all menus as a ReaperMenuSet	Click on Export... , choose Export All or Export Current , then type a name and click on Save .
Replace the current custom menu or all menus with a previously saved Reaper Menu Set	Click on Import... then select the required menu set file, then click on Open . You can also drag and drop .ReaperMenu and .ReaperMenuSet files into REAPER from Windows Explorer.
Include REAPER's default menus with your custom menus	Tick the Include default menu as submenu option (top right of window). This is recommended especially if you are removing any default commands from the menu.

Example

In this example you will learn how to add an action to a REAPER menu as a new command, and how to remove an unwanted command. You'll also change the order of some commands. As with many other exercises in this User Guide your main focus should not be on the example itself but more on the technique.

Suppose that you do a lot of work with markers, and that you would like to renumber markers in timeline order quickly and easily without having to remember a keyboard shortcut. You could add the action to the Ruler context menu. While you're about it, you can also remove the command **Insert empty space in selection** (assuming for the sake of the example that you think you do not need this command). Follow these instructions.

15 - Customization: Actions, Mouse Modifiers, Menus and Toolbars

Example

1. From REAPER's **Options** menu, open the **Customize menus/toolbars** window.
2. Display the drop down menu list and choose **Ruler/arrange context**.
3. Click on any one of the commands in this menu – for example **Set selection to items**.
4. Click on the **Add...** button, then choose **Action...** This causes the Actions List Editor window to be opened.

5. In the filter box type: **mark renum** – this should find the action **Markers: Renumber all markers in timeline order**.
6. Select this action then click on **Select/close**. The Actions window will close and you will be returned to the Customize menus/toolbars window. This action has now been added to the menu and is selected (see right).

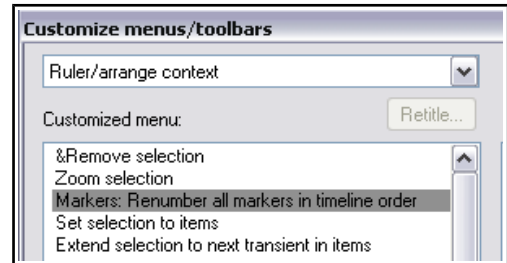

7. With the item still selected, click on **Rename...**
8. You will be prompted for a new name. Type: **Renumber markers** and press **Enter**.
9. To move this up the menu, drag and drop it above **Zoom selection**.
10. Now select the item (lower down the list) **Insert empty space in selection**. Click on **Remove** to remove this from the menu.

11. Make sure you have enabled the option **Include default menu as submenu**.
12. Click on **Save** then **Close**.
13. Create some markers in this project, out of timeline order.
14. Now right-click over the ruler/timeline (see right). Choose **Renumber markers** from the menu: your markers will be renumbered.

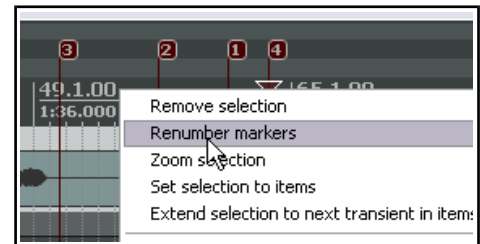

15. Notice at the bottom of this context menu the item **Default menu: Ruler/arrange context**. This can be used to access the original context menu.
16. If you wish to restore this menu to its original state, open the **Customize menus/toolbars** window again and with the **Ruler/arrange context** still selected, click on **Reset** then **Reset current menu/toolbar to default**. Click on **Save** then **Close**.

15.23 Customizing the REAPER Toolbars

Customizing REAPER's main toolbars (including the MIDI Editor toolbars) can make it easier to make REAPER work for you to work the way that you would like it to. For example, you can:

- Remove any of the default icons/commands that you do not wish to be shown.
- Assign a different REAPER command or action to any existing icon.
- Assign a different REAPER command or action to a new icon.
- Assign a custom action or macro of your own to a new or existing icon.

The procedure is similar to that used for menu customization. Make your changes to the existing default toolbar layout thru the **Customize menus/toolbars** dialog box. This can be displayed by right-clicking over the empty area of the toolbar background, or by choosing **Customize menus/toolbars** from the **Options** menu. When the Customize menus/toolbars window is displayed, choose **Main Toolbar** or one of the **MIDI View** toolbars from the drop down list in the top left corner. We'll get to **Floating toolbars** a little later in this chapter.

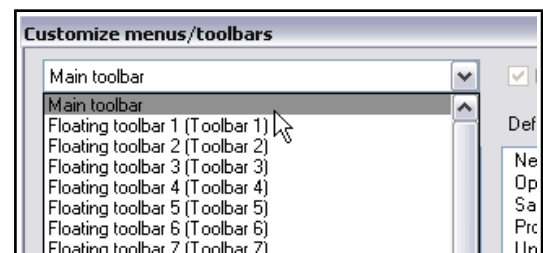

The table below summarizes the main tasks that can be carried out within this window.

After the table there is an example in which you can add to the toolbar an item of your own.

Purely as an example, we'll use the action **View: Toggle master track visible** for this.

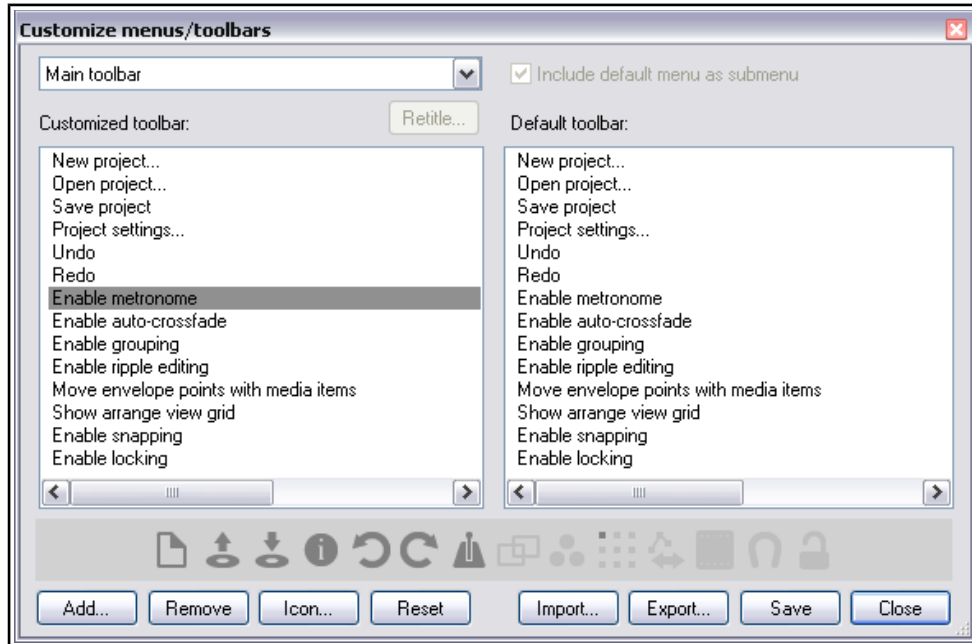

In order to do this you need to do this.
Change the name of a REAPER toolbar	Select toolbar from drop down list. Click on Retitle... , type new name then click on OK .
Remove an item from the toolbar	Click on either the item name in the left panel, or on the icon itself in the display just above the window's command buttons. In the example shown, Enable Metronome has been selected. Click on the Remove button.
Add a new action or command to the toolbar	In the customize toolbar area (left panel) select the item before which you wish to add your item. Click on the Add button. This causes the Actions window to be displayed. From the list of actions, select the REAPER command, action or custom script or action. Click on Select/Close . REAPER will add this to your toolbar and assign an icon.
To add a separator space between two toolbar items	In the customize toolbar area, right-click over the second of these items and choose Add separator from the menu.
To change the icon used for any toolbar item (including an item that you have added)	Right click over the icon in the icon display near the bottom of the Customize Menus/Toolbars window, just above the command buttons. This causes the Select toolbar icon window to be displayed. Select your required icon then close the Select toolbar icon window.
Change the action assigned to a toolbar button	In the customize toolbar area (left panel) select the item that you wish to change. Right click, choose Change action , then select from the action list and click on Select/Close .
Replace a toolbar icon with text	Right click over the item in the customized toolbar list in the left panel. Choose Text Icon from the menu, type the text then click OK .
Change the position of an item on the toolbar	Use the mouse to drag and drop up or down the list shown in the customized toolbar list. Ctrl X / Ctrl V may also be used, as can Cut and Paste from the right click context menu.

15 - Customization: Actions, Mouse Modifiers, Menus and Toolbars

In order to do this you need to do this.
Close the Customize Menus/Toolbar Window without saving your changes	Click on the Close button. Choose No when asked if you wish to save your changes.
Save the toolbar with your changes	Click on the Save button.
Restore the toolbar to its default status	Click the Reset button. Choose Reset Current Menu/ Toolbars to Defaults from the menu. Select Yes to confirm'
Export the current custom toolbar or all toolbars/menus as a ReaperMenuSet	Click on Export... , choose Export All or Export Current , then type a name and click on Save (see also note below).
Replace the current custom toolbar or all toolbars/menus with a previously saved Reaper Menu Set	Click on Import... then select the required menu set file, then click on Open .(see also note below)

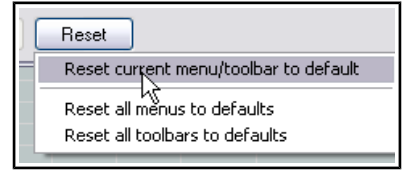

Note: ReaperMenuSets can also be included when exporting/importing REAPER configuration preferences and settings – see Chapter 22.

Example

The real benefit of this exercise will come from it teaching you a technique, not from the actual example.

1. Right-click over the toolbar area (but not any specific tool) and choose **customize toolbars...** from the context menu.



3. Find the action **View: Toggle master track visible**. Select this, then click on **Select/close**. This item will now be added to the list of toolbar items. In the icon display, it will be labelled something like "Tog Mast".

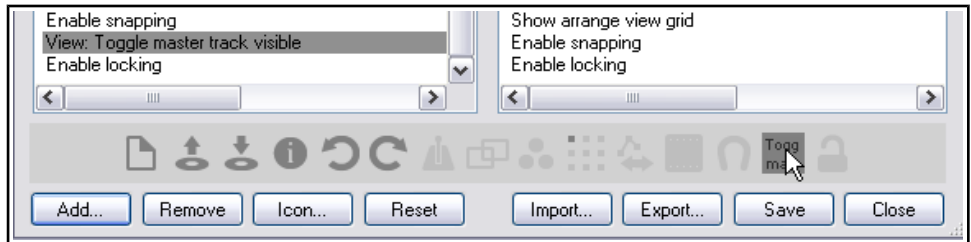

4. Drag this item up or down the list to whatever position you want it to take.
5. If you do not like the text **Tog Mast** you can right-click over the item in the list and choose either **Change icon** (to select an icon) or **Text icon** (to type a different text label). If you choose **text icon**, you may also select a **Double width toolbar button** option for better text display.
6. Click **Save** and then **Close**. If you don't want to keep this icon, access the customize menus/toolbars window again and simply remove it.

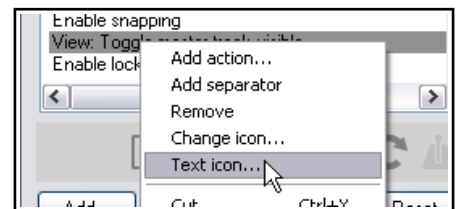

Tip: The command **Position toolbar** can be used to change the position of or float the main toolbar: see section immediately below this one.

15.24 Creating Additional Custom Toolbars

REAPER can display up to 16 general and eight MIDI only additional toolbars that you can set up to suit your particular requirements. By selecting which items are added to these toolbars you are able to create one click access to your most important commands and actions. To toggle the display of any toolbar, right-click over the empty area of your main toolbar and choose the **Open toolbar command**, then select a toolbar. You may display as many of these toolbars as you wish. By default, each toolbar contains one icon, labelled "Edit Me". To change this, you will need to customize the toolbar (see below).

Each toolbar window can be dragged, resized and positioned anywhere on your screen. It can also be kept on top (using the pin symbol). Right click over the empty area of any custom toolbar to again display the menu shown (right). Options are:

Switch toolbar: selects another toolbar to display in its place.

Open toolbar: use this to open another toolbar.

Position toolbar: used to dock the toolbar at the main toolbar, at the top of the main window, in the toolbar docker (explained shortly), or to float.

Customize toolbars: use this to open the **Customize menus/toolbars** window to enable you to customize the contents of any of the toolbars. By default, the currently displayed toolbar will be selected for editing.

You can add commands to each or any of these toolbars as you wish. To select a different toolbar for editing after opening the **Customize menus/toolbars** window, display the drop down list from the top left corner of the Customize menus/toolbars window. The following table summarizes the main editing options.

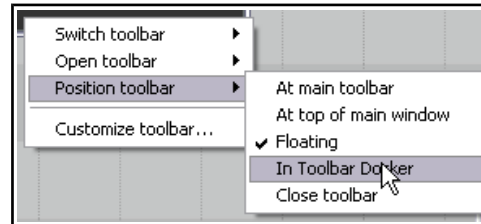
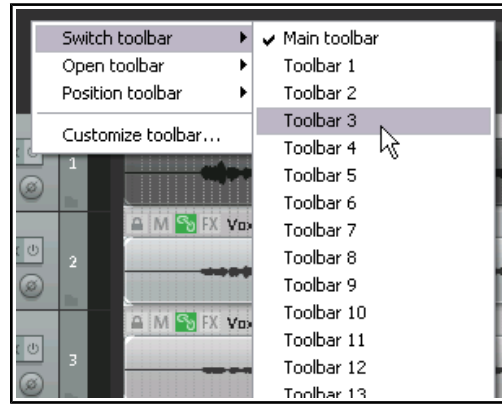

In order to do this you need to do this.
Change the name of any tabbed toolbar	Select toolbar in the Customize Menus/Toolbars window, click on Retitle... then type the new name then click on OK .
Add an action or command to a custom toolbar	Click on Add... to display the Actions List. Select the command or action and click on Select .
To edit a custom toolbar button label	Right click over the item in the customized toolbar panel (left) and choose Text Icon... Type the text then click OK .
To assign an icon instead of text to a custom toolbar button	Right click over the item in the customized toolbar panel (left) and choose Change Icon... Select the required icon from those displayed, then close the Select Toolbar Icon window.
To remove an item from a custom toolbar	Select the item in the Customized Toolbar (left) panel and click on Remove .
To change the order of icons on a custom toolbar	Drag and drop items up or down the list displayed in the customized toolbar (left) panel.
To save a custom toolbar set	Click on the Save button in the Customize Menus/Toolbars window.
To export a custom toolbar set	Use the Export... button and choose Export current menu/toolbar to ... Type a name and click on Save .
To import a toolbar set	Use the Import... button, select the file name, click on Open .
To dock/undock the floating toolbar	Right click on floating toolbar, choose Dock floating toolbar then select one of the three options.

15 - Customization: Actions, Mouse Modifiers, Menus and Toolbars

Shown here is an example of custom toolbars, used to give easy access to various track and windows screen sets. Let's see how this was done.

Example

1. With the **Customize menus/toolbars** window open select **Floating toolbar 1**.
2. Click on **Retitle...** and type **Screen Sets**. Press **Enter**.
3. Use the **Add...** button to open the Actions List window. Select **Screenset: Load window set #04**, then click on **Select**.
4. With the Actions List window still open, select the action **Screenset: Load window set #03** and again click on **Select**.
5. Repeat step 4 several times to select the other actions required for this toolbar.
6. Select the action **Screenset: Load track view #01** then click on **Select/close**.
7. If necessary, drag and drop any of these items up or down the list to put them in your preferred order.
8. If necessary, remove any unwanted items on this toolbar.
9. Right-click over each item in turn and choose the **Text icon** command. Enter a label, such as **Track Set 1** and enable the option **Double width toolbar button**.
10. **Save** and **Close** the **Customize menus/toolbars window** when finished.



This exercise has shown you *how* to create a custom toolbar. Only you can decide, however, *when* you should create them. Use them for those activities that you use the most. For example, if you find yourself getting frustrated when navigating and zooming, then make a zoom/navigate toolbar. If you spend a lot of time editing media items, make an item edit toolbar. In Chapter 18 you'll find a custom toolbar for working with envelopes.

15.25 Creating Smart Tools

If you have used other DAW software (such as Cubase, Pro Tools or Sonar) before coming to REAPER, then you may be used to using a toolbar to help with various editing tasks, such as splitting, deleting or muting items. You have already seen that this method of working is not native to REAPER. However, if you wish, you can create your own smart tools which can be used in a way similar to that with which you are familiar.

The Actions List includes a number of actions suitable for this sort of treatment. These include actions like **Item: Split Item Under Mouse Cursor**. In addition, you may also have created some custom actions of your own, for example to select and mute or delete items. Without arming, any tool which makes reference to the mouse cursor, for example, would otherwise be useless – because the mouse cursor will be over the toolbar, not any media item, when the tool is clicked! By using smart tools we solve this problem.

To create a Smart Tool for any action or custom action, you first need to assign the action or custom to the toolbar, as explained in the section before this one. In this example, we have created a button to

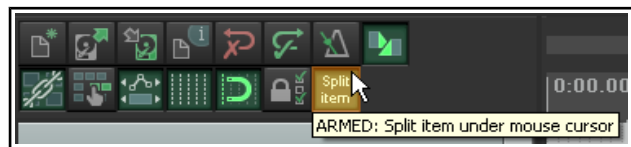

Split Item Under Mouse Cursor. Then, to use it as a smart tool, simply do this:

1. Right click over the tool. If you hover the mouse there long enough, a tool tip will be displayed. Move the mouse over any media item and it will change to a letter **A**.
2. Left click on (in this example) the item to which you want the action applied, at the exact position that you want the action to occur. In this case, the item beneath the mouse cursor will be split.

Once a tool is armed it will remain armed until you “unarm” it. To do this, either right click on the armed tool. or press Esc immediately after using it.

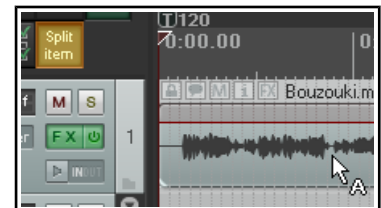

Tip: A floating toolbar can be sized (made larger or smaller) by dragging its lower right hand corner in or out – look for the small dotted triangular area. If you want to restrict just how large the icons may become when you do this, enable the option **Don't scale toolbar buttons above 1:1** on the Appearance page of your preferences window. There is also an option **Don't scale toolbar buttons below 1:1**.

15.26 The Toolbar Docker

If you have several custom toolbars, the toolbar docker can be a useful means of accessing your various toolbars easily without creating a lot of screen clutter. It uses a tabbed layout that makes it easy to switch between your various toolbars whilst only displaying the contents of one toolbar at a time. In addition to this, the toolbar docker can itself be docked in any of REAPER's main dockers.

Shown below is an example where a user has created eight custom toolbars and made them all accessible from the toolbar docker:

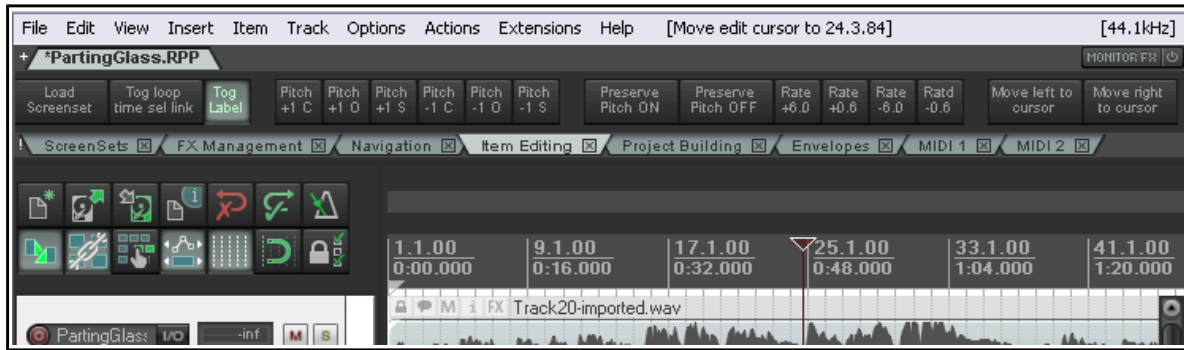

Display of the toolbar docker is toggled using the **View, Toolbar docker** command. A tip worth remembering is that toolbar layouts (tool positions) are by default saved with windows screensets. This makes it easier to switch between using and not using the toolbar docker, or using different toolbar selections in the toolbar docker at different times.

The following table summarizes the main features of the toolbar docker.

In order to do this you need to do this.
Add an open toolbar to the toolbar docker	Right click over the toolbar background area, choose Position toolbar, In toolbar docker .
Remove a toolbar from the toolbar docker	In the toolbar docker, right click over the toolbar's name tab, choose Position toolbar then Close toolbar or one of the display options such as floating or at top of main window.
Replace one toolbar on the docker with another	In the toolbar docker, right click over the toolbar's name tab, choose Switch toolbar then select the required toolbar.
Display toolbar contents	In the toolbar docker, click on toolbar name tab.
Dock the toolbar docker	Click on the ! (exclamation mark) on the left end of the toolbar docker, then choose any one of the four attach docker position options bottom, top, left or right. In the example shown above, this has been docked at the top.
Undock the toolbar docker	Click on the ! (exclamation mark) on the left end of the docked toolbar docker, then deselect the option Attach Toolbar Docker to main window .

16 REAPER Plug-ins in Action

16.1 What Are Plug-ins?

There's a wonderful assortment of plug-ins supplied with REAPER - over 200 of them! These include the Jesusonic and the VST Rea plug-ins from Cockos. In this section we will be introducing you to a selection of these. We will only be covering the very basics, just to give you a feel for what plug-ins are and how they work. Beyond this, you can explore for yourself.

Plug-ins are pieces of software that are used to control and shape the sound generated when you play back the media items in your tracks. Some simple examples of when and why you might want to use a plug-in are:

- To make a vocal recording sound nicer, more lifelike. Perhaps your dry recording sounds a bit thin, even verging on feeble in places. Plug-ins can add body, warmth and sparkle to such a track, not by working magic, but by finding where those qualities are buried in the recording and bringing them out.
- To smooth off peaks and dips in the volume of a track, making the overall track sound more even.
- To add a "live" feel to a track or even a whole mix, making it sound more as if it were recorded in a church or a concert hall, rather than in a boring old studio.

16.2 The Three Laws of Plug-ins

Before you start using plug-ins, study and memorise this mantra. There are no exceptions to these laws!

1. It is better not to use a plug-in at all than to use it badly. A badly used plug-in is likely to make your mix sound worse, not better. If in doubt, underdo the use of plug-ins, don't overdo them.
2. Never judge the quality of a plug-in by how much you like its presets. Presets reflect someone else's idea of how something ought to sound, not the quality of the plug-in, nor its potential. You will almost certainly never learn how to get the best out of any plug-ins, be they EQ, compression, reverb or anything else unless you take the trouble to understand their various parameters. And that takes time.
3. You can't judge the quality of a plug-in by its cost. No, really you can't. Some plug-ins are free. Some cost literally thousands of dollars. Some free ones are pretty awful, some are great. Some plug-ins costing hundreds of dollars are, to be polite, very, very ordinary. Others are excellent.

16.3 The Five Types of Plug-in

Especially when you are new to digital audio, when you start to explore the world of plug-ins you might find yourself feeling overwhelmed, if not utterly confused. Why? Because there is so much choice. *Heaven help me, have I really got to understand all that lot to be able to use this recording caper?*

No, you don't. Learn in steps as you go. In essence there are essentially five types of plug-in (well, there's a major exception to that, which I'll get to shortly). These five types are:

- **Sound Shaping:** these plug-ins affect the frequency (pitch) of your track(s). An example is EQ.
- **Time-Based Effects:** these plug-ins manipulate how your track(s) interact with time. Examples include Delay, Chorus and Reverb.
- **Volume Changing:** these are plug-ins that determine the overall volume or perceived volume of your track(s). Examples are Compressors and Limiters.
- **Routing Plug-ins:** these do not shape the sound of your tracks as such, but are used for tasks such as routing. Routing is generally beyond the scope of this chapter: we'll get to it in Chapter 17.
- **Analytical Plug-ins:** these display information, but don't in any way alter the sound of the track.

And that exception? Well, some plug-ins can cut across more than one of these categories at the same time, performing more than one job. One example of this is a Multiband Compressor, which displays the characteristics of both an EQ and a Compressor.

It would be way beyond the scope of this User Guide to teach you the science between these various plug-ins – that would require an entire volume in itself! Our objective is to give you an introduction to what REAPER offers in this area, and to show you how REAPER's own interface is used to control them.

16.4 Adjusting Plug-in Parameter Controls

Plug-in faders can be adjusted using any of four main methods. These are:

- ◆ Hover your mouse over the fader and scroll the mousewheel. Use **Ctrl** for finer adjustments.
- ◆ Click on a fader and drag the mouse. Hold the **Ctrl** key for finer adjustments. Hold **Alt** for "elastic" auditioning: the control will return to its original position when the mouse is released.
- ◆ Click on the fader then use the **Up** and **Down** arrow keys.
- ◆ Click in the parameter value window (in the first example show below, you can see one of these to the immediate right of each of the three horizontal faders) and type a value.

If you prefer not to use the first of these methods (for fear of making accidental adjustments), you can enable on the Editing Behavior, Mouse page of your Preferences the option **Ignore mousewheel on all faders**.

16.5 Sound Shaping Effects: ReaEQ

Many sound shaping plug-ins fall (in one way or another) into the EQ category. EQ means "equalisation." This is rather strange, since they are used to emphasise (or de-emphasise) selected frequencies. Perhaps they should be called "UnEQ"!

ReaEQ is the main EQ plug-in supplied with Reaper. There are also several JS EQ plug-ins but ReaEQ is the most powerful and flexible. Let's take an example.

1. Open the supplied project file **All Through The Night.RPP** and save it as **All Through The Night EQ.RPP**
2. This example uses only the vocal track, which is an excellent tool for demonstrating EQ. **Solo** the **Vox** track.
3. Display the **FX window**, click on **Add** and add **Cockos VST: ReaEQ**. Notice that by default this has 4 band tabs (numbered 1 to 4).

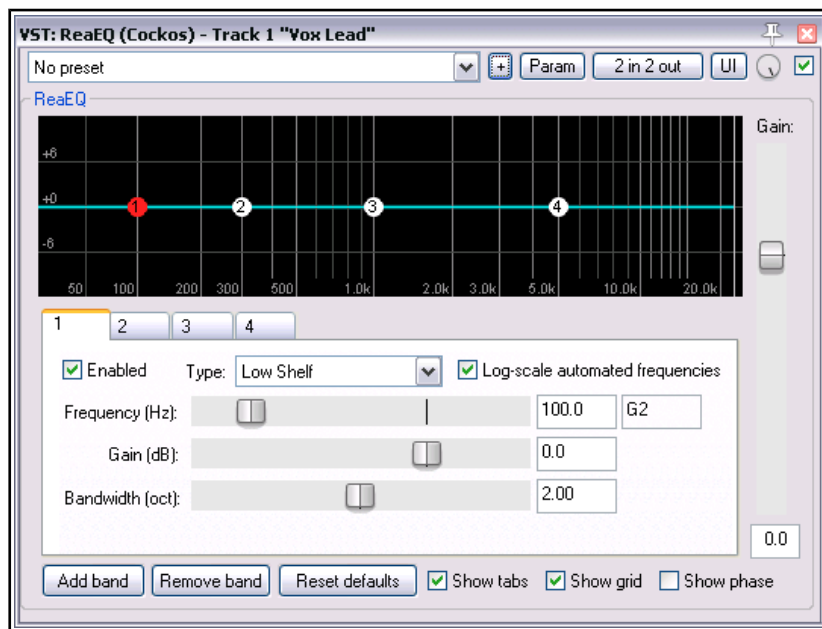

4. Play the song. As you do so, select **Band 4** and fade the **Gain** left to about - 35 dB. Notice how deep the voice becomes. Double click on the fader to return it to the centre.
5. Select **Band 2**. Fade the Gain down to about - 14 dB. Notice how tinny and even disembodied the voice sounds. Double-click to return to normal. Now lift the Gain to about +3 dB. The voice should sound quite pleasantly fuller and warmer. Select Band 3 and set the Frequency to about 4200. Observe what happens as the gain is adjusted between +3.5 and -3.5. When finished, return it to 0.0. Save the file.

What has been happening is that you have been adjusting frequencies This is a huge subject. It is way beyond the scope of this guide to teach everything there is to know about EQ, but here is a brief introduction. Exactly how you divide up the frequency spectrum is to some extent arbitrary. Here's one way that makes sense:

Frequencies	Comments
16 to 60 Hz	Very Low Bass. These frequencies are felt rather than heard.
60 to 250 Hz	Bass. Herein dwell the fundamental notes of the rhythm section. A modest boost here can help make a sound fuller, but too much gain will make it boomy.
250 to 2000 Hz	The Mid Range. Too much gain here makes it sound like you've recorded from the other end of a telephone. If a take sounds muddy, try cutting it here.

Frequencies	Comments
2000 to 4000 Hz	Upper Mid Range. Often a tricky area. Too much can cause listening fatigue. Lower this range a tad on the mix while boosting a tad on vocals can help a vocal stand out.
4000 to 6000 Hz	Presence Range. This is the key range for clarity and presence of instruments and vocals. Some gain here will bring the instrument or voice forward in the mix. A drop here can pull a vocal or an instrument back.
6000 to 16000 Hz	High Range. This is where you find clarity and sparkle. Too much gain here produces a searing, glassy effect. Not enough will sound dull and "heavy".

So ... we know that the frequency is measured in Hz (and kHz), and that we can increase or decrease the volume at any level, to shape the sound. The sound level itself is measured in decibels.

We need to understand two more terms – first, band width. ReaEQ measures bandwidth in octaves. A narrow bandwidth setting means that you will raise or lower the sound over a very small part of the spectrum relative to your selected frequency. A wide setting means that you will be working on a much wider part of the spectrum. An example of the difference in how a narrow bandwidth (top) and a wide bandwidth (bottom) can shape a sound is shown here.

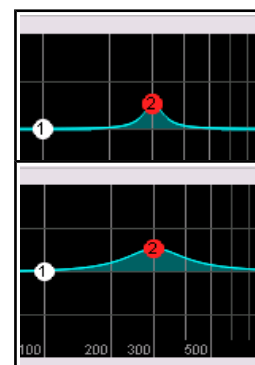

You will also see, if you display the drop down list labelled **Type** that there are several type of band. Some of the most commonly used are:

Band: the volume is raised or lowered either side of the frequency, the range being determined by the bandwidth setting. Sometimes called a "peaking filter."

Low/High Pass: Filters out frequencies above/below the frequency setting.

Low/High Shelf: Causes the gain to be lowered or raised below/above the frequency setting.

Pass and Shelf will in most cases only be used (if at all) at very low frequencies or very high frequencies.

You can add or remove bands using the Add band and Remove band buttons.

Tip: Don't forget that you can create track parameter controls and/or automation envelopes for this or any other plug-in by clicking on the **Param** button in the plug-in window – as explained in Chapter 11.

16.6 Time Based Effects: Delay

These include reverb, delay and chorus. Sound takes time to travel thru any distance, and surfaces like walls and ceilings create reflections which make the sound patterns even more complex, intricate – and alive. Time based FX use a number of tricks and techniques to artificially simulate this, thereby creating a more "live" sound. But be careful. Too much here can ruin an otherwise good sound.

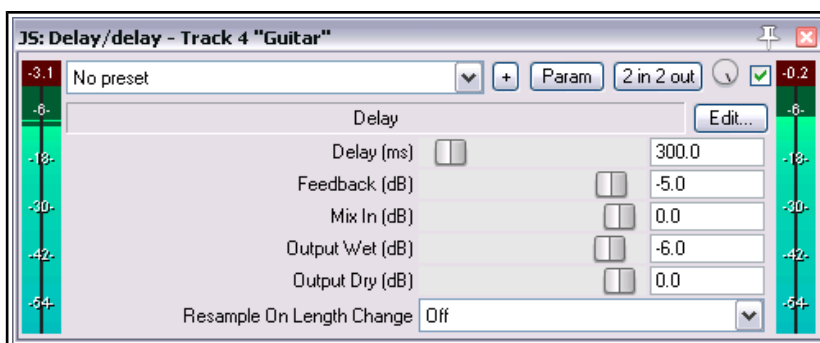

Parameter	Description
Delay (ms)	Determines the amount of time that passes between the original sound and when the delayed sound is heard.
Feedback	Determines the amount of the delayed signal that will be fed back into the delay itself. This helps to prevent the delay from just being an echo.
Mix in (dB)	Determines the overall output level.

Parameter	Description
Output wet (dB)	Determines the Output level of the Post FX signal. Lowering this relative to the dry output will make the effect more subtle.
Output dry (dB)	Determines the Output level of the Pre FX signal

In this example, we will use the **JS: Delay/Delay** to add a touch of delay to the Bouzouki.

Example

1. Unsolo your Vox track and solo the track Bouzouki. Open its FX Window and add the JS:Delay/delay.
2. Play the song. Experiment with adjusting the FX parameters until you have found an effect to your liking. For very small delay settings, such as 0.2 ms, it is easier to type them in the box than to use the faders.
3. Unsolo the track, then continue to make any further adjustments until you are satisfied with the results.
4. Save the file.

Note: The plug-in **ReaDelay** is a more powerful alternative to JS Delay. In particular, it allows you to create multiple delay taps, each with its own delay settings, and to pan each of these individually.

16.7 Volume Changing Plug-ins: the Limiter

In this next example, we will look at an example of one volume changing effect, the JS:LOSER:masterLimiter. This can be added to the FX Window for your MASTER to perform two functions. These may at first appear to be contradictory, but they are not:

- To raise the overall volume of the mix, but at the same time ...
- To prevent the mix from "clipping", i.e. getting too loud at any point.

We will be using the **JS:Loser/masterLimiter** which includes the following controls and parameters:

Parameter	Description
Threshold	Determines the level at which the other limiter settings will be applied. It may seem paradoxical, but the lower the threshold, the higher will be the perceived overall volume. As you lower the threshold, more of the song is lifted to the limit specified.
Look Ahead	Determines how far ahead the limiter looks – this helps smooth out sudden peaks.
Attack	Determines how quickly the limiter kicks in as the signal increases.
Release	Determines how quickly the limiter recovers after a peak is encountered.
Limit	This determines the maximum volume that cannot be exceeded.

Example

1. Display the FX Window for your MASTER and insert the **JS: LOSER /masterLimiter**.
2. Play the song, adjusting the controls.
3. As you lower the Threshold, the volume will get louder, but the maximum (limit) volume is never exceeded.
4. As you lower the Limit, the song gets quieter.
5. The more you lower both Threshold and Limit, the more you squeeze the dynamics out of the song – volume remains almost constant, and there is little or no movement in the VU.

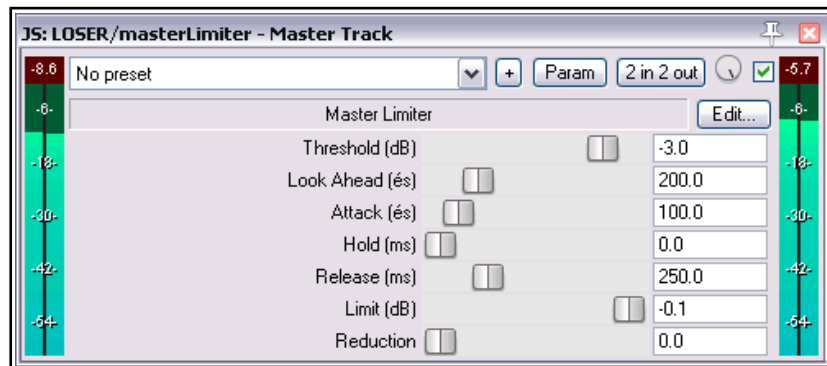

The trick to using a limiter well is to smooth out peaks and dips somewhat, but without adversely affecting the dynamics of the song. And, especially at first, be gentle!

16.8 Analytical Plug-ins: the Frequency Spectrum Analyzer

Shown on the right is a **JS: Frequency Spectrum Analyzer Meter (Cockos)** plug-in.

Insert this into any track's FX chain (or the master's FX chain) and as the project is played you are given visual feedback as to the level of output at different frequencies.

This plug-in is explained in detail in the free **REAPER Cockos Effects Summary Guide**.

Three of the Cockos plug-ins – ReaEQ, ReaFir and ReaXComp - all include an analytical display similar to that shown here as part of their standard interface.

Now that you've had a look some examples of different types of plug-in. We can go on and examine some more.

First, though, another word or two about presets ...

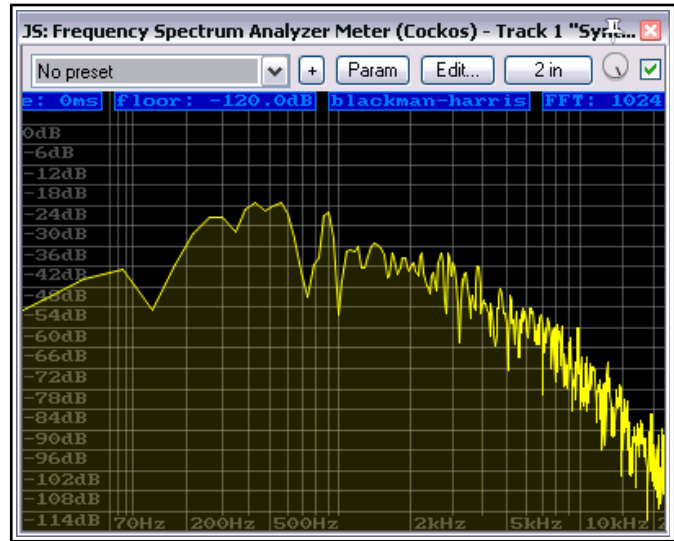

16.9 Using FX Presets

When you are satisfied with your settings for any plug-in, you might wish to save them as a preset, so that you can apply them next time you want to use it on another track:

1. Click on the **+** button just above the JS Delay/delay plug-in when this plug-in is selected.
2. Choose **Save preset** from the menu.
3. Type a name and click on **OK**.

To save these as default parameter settings for the plug-in when it is used in the future, use the **Save preset as default...** command from the same menu.

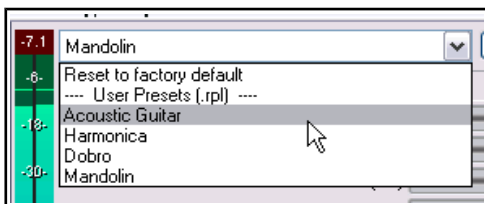
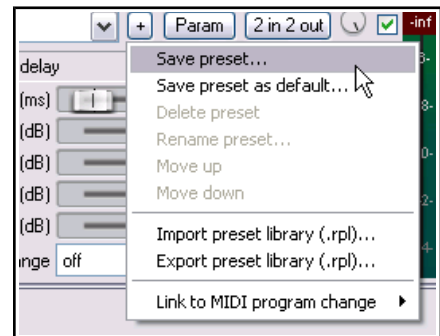

To import an existing preset library (such as you might be able to download from the REAPER web site) you would choose **Import preset library...** To export your presets to a file (for backup purposes, or to use on another computer) you would choose **Export preset library** ...

To choose an existing preset (from those previously saved or imported, or which were supplied with the plug-in), insert the plug-in into that track's FX window, display the drop down list of presets (see above), then select the one that you want.

Within the FX Browser, you can select a preset when adding an FX to the FX chain. Right-click over the plug-in name then from the context-sensitive menu choose **Presets**, then select the required preset from the displayed list.

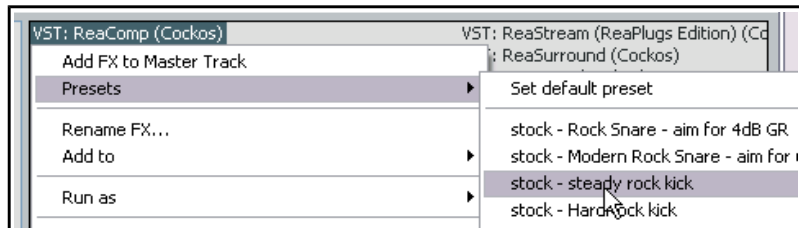

16.10 Time Based Effects: ReaVerb

ReaVerb is a VST plug-in that is supplied with REAPER. Reverb itself is a time-based effect, and ReaVerb uses a type of reverb known as **convolution reverb** to create the illusion of space. This section will introduce you to the basics of using ReaVerb. After that, it has more features that you can explore for yourself.

Most reverbs attempt to simulate the effect that the acoustic environment of, say, a hall or a room would have on sound. However, the mathematics required is complex, so that few come close to sounding like real acoustic rooms. Reverb plug-ins vary not only in their essential quality but also in the scope of their applications.

Convolution reverb can give you realistic reverb on a budget. It uses impulse responses of real acoustic spaces. This is done by first generating a signal in the required environment and then recording the result.

ReaVerb even takes this concept a step further, allowing you to not only use recorded impulses from real environments to create your reverb, but also to use something closer to more traditional reverb methods to then modify that sound further, should you wish to do so.

To be able to use convolution reverb, you will need a collection of impulse wave files. Search the net and you'll find all you want, many free. This example uses files downloaded from <http://www.voxengo.com/impulses/>. In the example that follows, these files have been downloaded and stored in a folder that we have created and named **C:\Program Files\REAPER\Reverb Impulses\Voxengo**

Example

1. Open the file **All Through The Night.RPP** and save it as **All Through The Night REVERB.RPP**
2. Add a new track after the last track, and name it **Reverb Bus**
3. Create Receives into this track from all of the instrument tracks and the Vox track. This will later enable you to feed different levels of signal, panned as required, from different tracks into your Reverb Bus.
4. Display the **FX Window** for the **Reverb Bus**.
5. Add **ReaVerb** into this FX Window.
6. Fade the **Wet** level down to around **-60** and the **Dry** level down to about **-0.5**, as shown above. We will start by adding just a little reverb, then increase it as required.
7. Click on the **Add** button and then on **File**. This lets you add a file at the start of your Reverb chain. Navigate the file browser window to where your impulse files are stored and select one. In this example, we will be using **St Nicolaes Church.wav**
8. Click on **Open** to insert that file into ReaVerb.
9. **Play** the file. In the Track Window, lower the Volume fader for the Reverb Bus to about **-10dB**. Lower the fader on the Master to about **-6dB**. You can bring this up again later if you wish.
10. In the ReaVerb window, now raise the wet signal until you hear a pleasing amount of reverb. This will probably be at about **-10 dB**. If you like, Solo the Reverb track for a while, so that you can discern the effect more clearly.

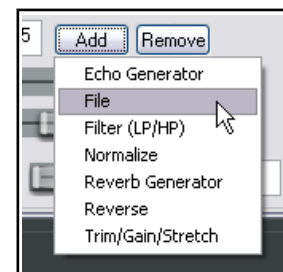
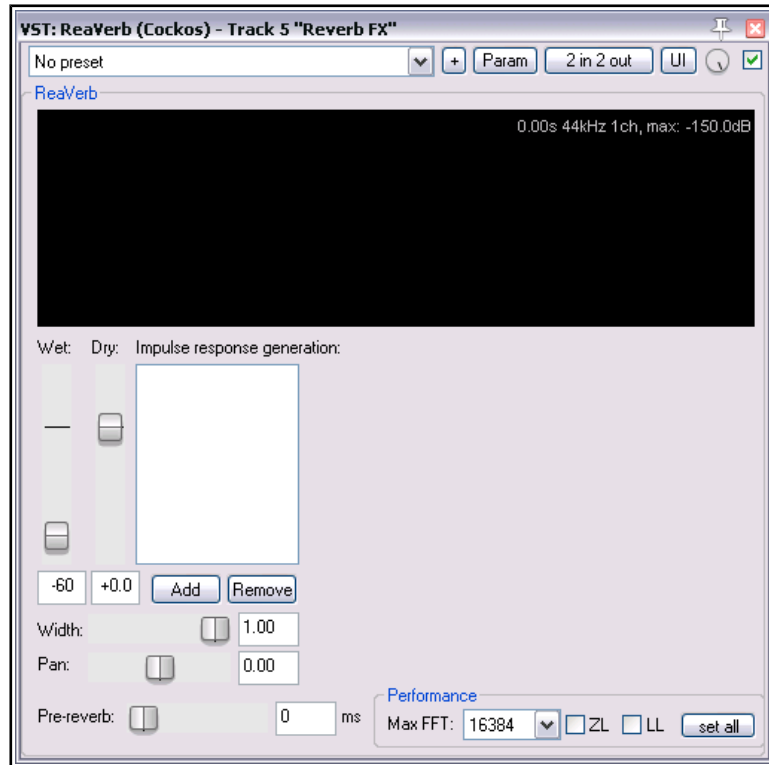

11. We can now use the ReaVerb controls to adjust the Reverb effect. The **Pre-reverb** fader offsets the reverb tail by delaying the signal that is sent to the reverb tail generator. Try it for yourself.
12. To add more controls to the Reverb chain, click on **Add** and choose **Time/Gain/Stretch**. Your window suddenly has all these extra controls. These are used to stretch the impulse (make it longer), add in some graininess, or trim the impulse (make it shorter). The best way to find out is to experiment!
13. Now click on **Add** again and add a **Filter (LP/HP)**. This causes a High Pass Filter and a Low Pass Filter to be added. This can be used to stop the reverb impulse from being added to very low and/or very high frequencies.
14. When you have your sound right, you can save that set of parameters as a named preset that can be recalled for other projects. Click on the + button, choose **Save preset**, name the preset and click **OK**.

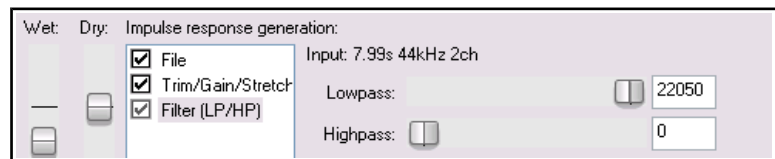
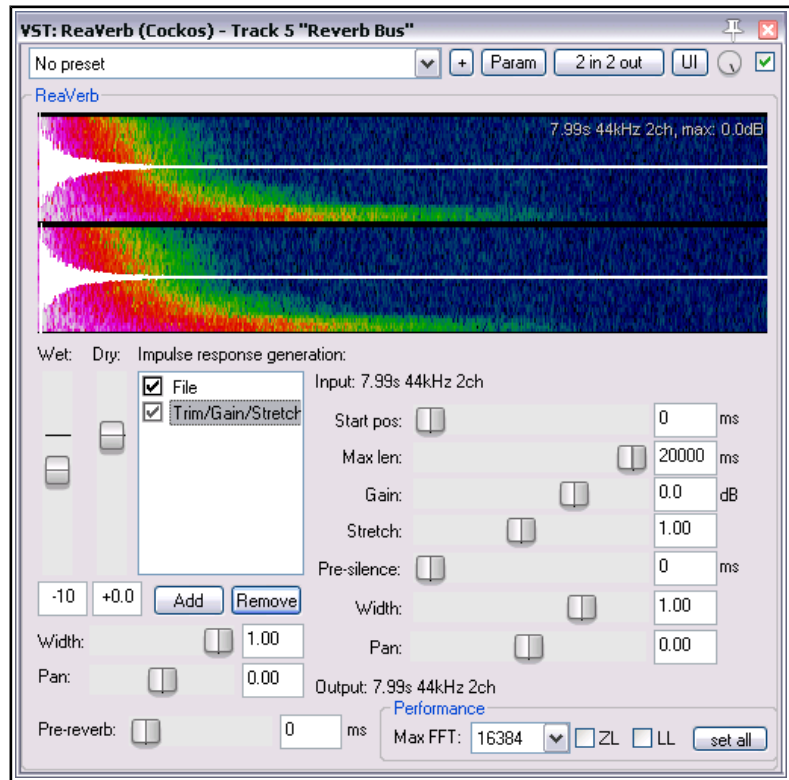

Notice that when you are experimenting with ReaVerb you can:

- Drag and drop to change the order in which modules are positioned in the reverb chain.
- Untick the box to the left of any module's name to bypass that module.

Tip: When making changes to ReaVerb settings it may be necessary to first stop and then restart playback for those changes to be employed.

ReaVerb Features Summary

Echo generator - generates an echo - useful for "filling in the gaps" of an impulse or creating echo-decay.

High and low pass filter - force the impulse not to work above or below a certain point.

Normalize - raise the gain of the impulse to 0dBFS.

Reverse - reverses the Reverb - a nifty effect for vocals, guitar solos and song intros/outros.

Trim/Gain/Stretch - trim or stretch the impulse (make it shorter or longer), add in some graininess.

File - use this to insert an impulse file. You can insert as many files as you want!

Max FFT - FFT filters are a complex mathematical topic. Google to learn more details! Meanwhile, for the rest of us, changing the FFT size changes CPU usage. A lower FFT setting means a higher CPU usage, but spread more evenly. Higher FFT sizes will consume less CPU but result in more latency. FFT size will therefore affect performance and possible dropouts, but it should not affect the sound itself. If unsure, use the default setting.

ZL - option to enable zero latency: useful when tracking while monitoring reverb levels.

LL - option to use an extra thread to improve low latency performance.

You may find when rendering that better results are obtained with both ZL and LL disabled.

Set all - apply these performance settings to all instances of ReaVerb in the current project.

16.11 Volume Control with Compression: ReaComp

Earlier in this chapter, we encountered a **Limiter**. You can think of a limiter as being like imposing a ceiling – it stops the volume of a signal from going above whatever level you set.

Because limiting can be harsh, it is often better to use a compressor on individual tracks. Think of it this way – a simple limiter cuts in suddenly and severely, whereas a compressor can be eased in much more gently. It might help to get a visual picture of what limiting can do to a recording compared to a well applied compressor. The three illustrations show the same waveform first as recorded, then how it might look with limiting (center), and with compression instead of limiting (right).

Notice that on the original waveform the volume varies quite considerably from time to time.

Applying a limiter (near right) can lift the quieter passages, but may make the overall effect too loud. The dynamics have been largely squeezed out of the song.

The illustration far right shows the same waveform after carefully using a compressor instead of a limiter. The track no longer clips, and more of the dynamics of the recording have been preserved.

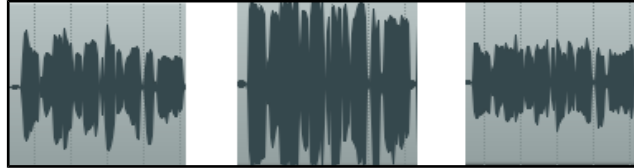

Software compressors vary from the simple to the complex. We're going to concentrate here on understanding just five main terms.

These are essential to understanding how to use compression. There are other factors, but let's just focus on these five for now.

- **Threshold** - This is the volume at which the compressor will kick in. For example, if you set your threshold at, say, -10dB, then nothing below that threshold will be compressed at all.
- **Ratio** – This determines how gently or severely the compression is required. For example, a relatively gentle ratio like 2 to 1 would ensure that for every 2 decibels the volume of the recording goes above the threshold, the sound will be increased by only 1 decibel. A much more severe ratio of 12 to 1 would mean that for every 12 decibels the recording goes over the threshold, the sound will increase by only one decibel.
- **Gain** – This is how the volume of the track is adjusted after compression. Often you will want to raise the overall sound at least a little, to prevent the overall volume of the track from now being too quiet. The gain control in **ReaComp** (above) is labelled **Wet**.
- **Limit Output** – Selecting this option will prevent the compressor output from exceeding 0 dB.
- **Bypass** – this is the small tick box in the top right corner, next to the UI button. You can use this to toggle bypass on and off, enabling you to assess what this plug-in is doing. When this is ticked (as here) the plug-in is active. When unticked it is set to bypass. You'll find one of these in all plug-in windows.

Example

1. Open the file **All Through The Night.RPP** and save it as **All Through The Night COMP.RPP**
2. **Solo** the **Bouzouki** track. Look at its media peaks. You can see that it starts at a steady volume, but over the last 30 seconds or so of the song it gets rather loud.
3. Play the track from the 55 second mark for about 15 secs then stop it. Try applying some compression to kick in at about -12 or -13 dB.

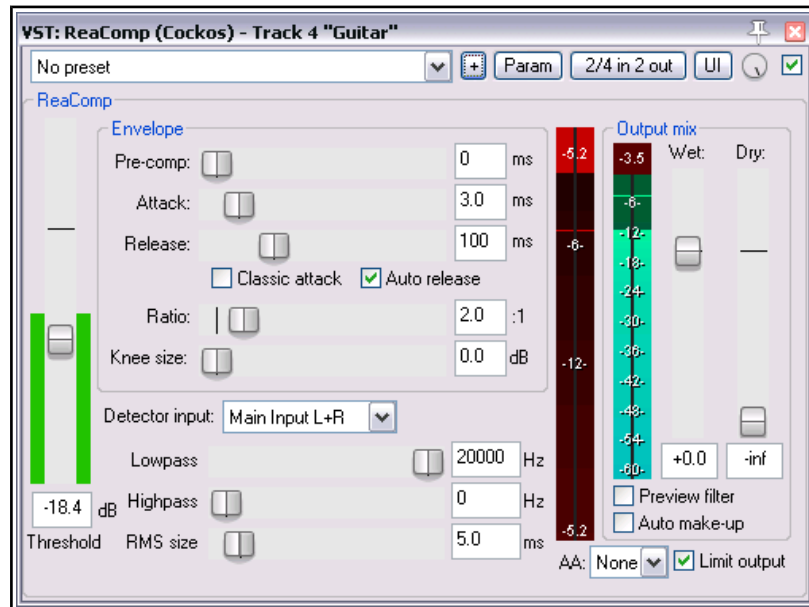

4. Display the FX Window for this track.
5. Insert the **VST: ReaComp (Cockos)**.
6. Create a loop to play over the last 20 secs or so of this instrument.
7. As you do so, experiment with setting the Threshold (vertical fader on the left) and the Ratio. Select the option to **Limit** Output. You'll probably end up with a setting of something like -16 on the Threshold and a ratio around 4:1 or 5:1 (see picture).
8. Now save this file.

16.12 JS Transients Plug-ins

Used well, a compressor can enrich a track or a mix, but used badly it can do more harm than good. If you're not too confident about using a compressor, you could do worse than look at the **JS Transients Killer**. It's a simple compressor (more like a clipper

really) with just two parameters for you to control – Threshold and Ratio. All other settings are fixed. The threshold determines the volume at which compression begins – the ratio determines how much compression is applied.

Feeling a little more adventurous? Try adding the **JS Transient Controller** immediately after this, to add more sustain and/or attack to the track, folder or mix.



16.13 JS De-Esser

The JS de-esser is a specially crafted compressor whose purpose is to remove sibilance from vocal tracks.

It works by combining either a highpass or bandpass filter centred on a specific frequency with a compressor to tame the sibilance.

By turning **Monitor** on you are able to sweep the **Frequency** control to identify where the sibilance is worst, then turn Monitor off again. As a rough guide, male sibilance is likely to be found at around 4500 Hz and female at about 6500 Hz – but these can vary with individual singers.

The **Bandwidth** determines how wide or narrow will be the frequency range to which the compression is applied.

Threshold, **Ratio** and **Gain** work in the same way as in a normal compressor.

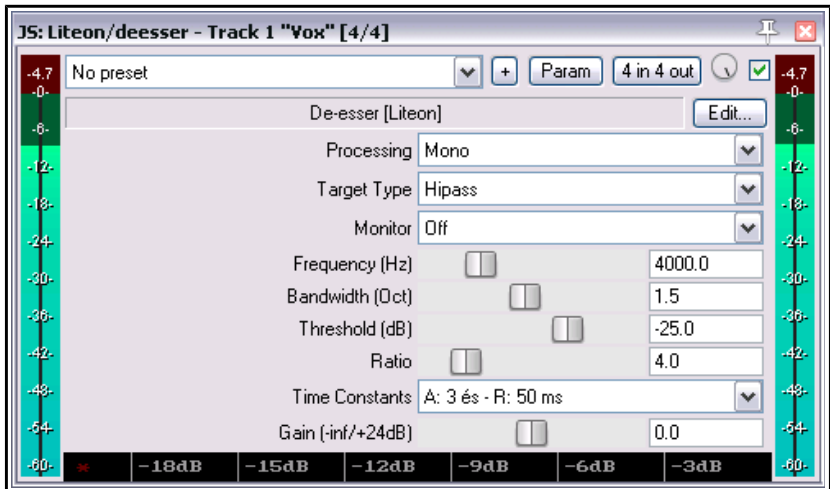

16.14 Volume Control with a Noise Gate

Noise Gates controls sound at the quiet end of the scale. Often when you record a track such as a vocal there will be sections of silence, perhaps between verses. At least, you want them to be silence! However, you might notice on playback irritating sounds have been recorded at a low level during these periods. A noise gate can be set to detect these and filter them out. Like the compressor, the Noise Gate can be quite simple or more sophisticated. For now, we're going to focus on just the basic Noise Gate controls:

- **Threshold** – Used to specify a minimum sound level below which the Noise Gate will kick in.
- **Attack** – Specifies how quickly the gate should kick in. Too short an attack period can cause it cutting out the natural decay of a sound you want.
- **Hold** – This specifies how long the gate remains open after the signal falls below the Threshold
- **Release** – This determines how soon the gate closes after the signal has fallen below the Threshold.

Let's take an example, using the project **All Through The Night COMP.RPP**

Example

1. Solo the Vox track.
2. Play the song from just before the end of the first verse. If you listen carefully (especially thru headphones) you can hear some unwanted sounds during the otherwise silent passage. Certainly you can see this on the track's VU meter.
3. Open the FX Window for this track and add **Cockos VST ReaGate**.
4. Play the song again. Adjust the **Threshold** fader (the first on the left) to a level just above that at which the Threshold's VU meter is peaking during the quiet passages (see below). This will shut out the sound – visual confirmation is given by the VU meter on the right, which should now display no activity.
5. You will probably find that the default settings for Attack, Hold and Release work quite well, but experiment with adjusting them if you wish.
6. Now save this file again.

You have just seen here a simple example of using a noise gate. Noise gates can be used to great effect and for a large number of applications (including with a drum kit to cut out the bleed between mics). Applications like that are more complicated and require a greater understanding of the noise gate's many parameters.

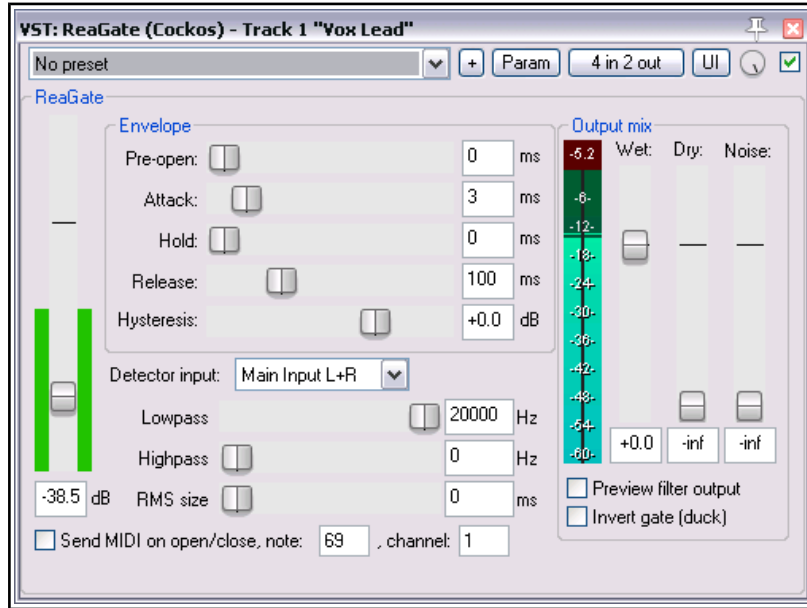

16.15 Stillwell Chorus and Delay Effects

If you have ever owned an acoustic guitar then you probably know what a chorus effect is. You might have used a chorus pedal at some time to make your guitar sound fuller and richer, almost like two or more guitars.

REAPER includes a number of chorus effects. Shown here is **Stillwell's Chorus_Stereo**.

This uses similar principles to the delay plug-in that we encountered earlier. It has a number of additional controls, the most



important of which is **Number of Voices**. Try it and see! This is another plug-in where you'll find the wet/dry mix control and bypass toggle tick box (top right) can be very useful.

Other chorus/delay effects from Sstillwell include a mono **Chorus** effect, **Delay_Pong** (creating a delay effect which can be ping-ponged between left and right speakers), and **Delay_Tempo** (a simple delay effect). For a really unusual delay effect, try experimenting with **remaincalm's floaty delay**.

16.16 Noise Reduction with ReaFir

ReaFir is a multipurpose dynamics plug-in that almost defies categorisation or description. It can act as an EQ, a Compressor, a Noise Gate, and more. In this example, you will see how it can be used for noise reduction. The need for a noise reduction plug-in can arise when an otherwise good track has some unwanted background noise on it. This might, for example, be hiss or rumble, or the sound of an air conditioner.

ReaFir can be used to remove such sounds from your tracks in real time. In order to do this, you must first identify a passage on the track (perhaps a second or two) where you have recorded the unwanted noise by itself. This is likely to be at the very beginning of the track.

Example and Procedure

In overview, the procedure is this:

1. Insert **ReaFir** in the FX window of the track containing the recorded items with the unwanted noise.
2. Position the play cursor at the start of a passage containing just the unwanted noise.
3. Set **ReaFir** to **Subtract** mode.
4. Set Edit Mode to **Precise**.
5. Select the Option to **Automatically build noise profile**.
6. Play the track only for the duration of the passage containing the noise, then stop the playback.
7. You should see that **ReaFir** has built a profile of the unwanted noise. This will be marked with a red line (see above right).
8. Now uncheck the box labelled **Automatically build noise profile**.
9. Return the play cursor to the start of the song and play it.
10. You should now find that as the song plays, the noise that you profiled by following steps 1. to 5. has now been removed from your output..

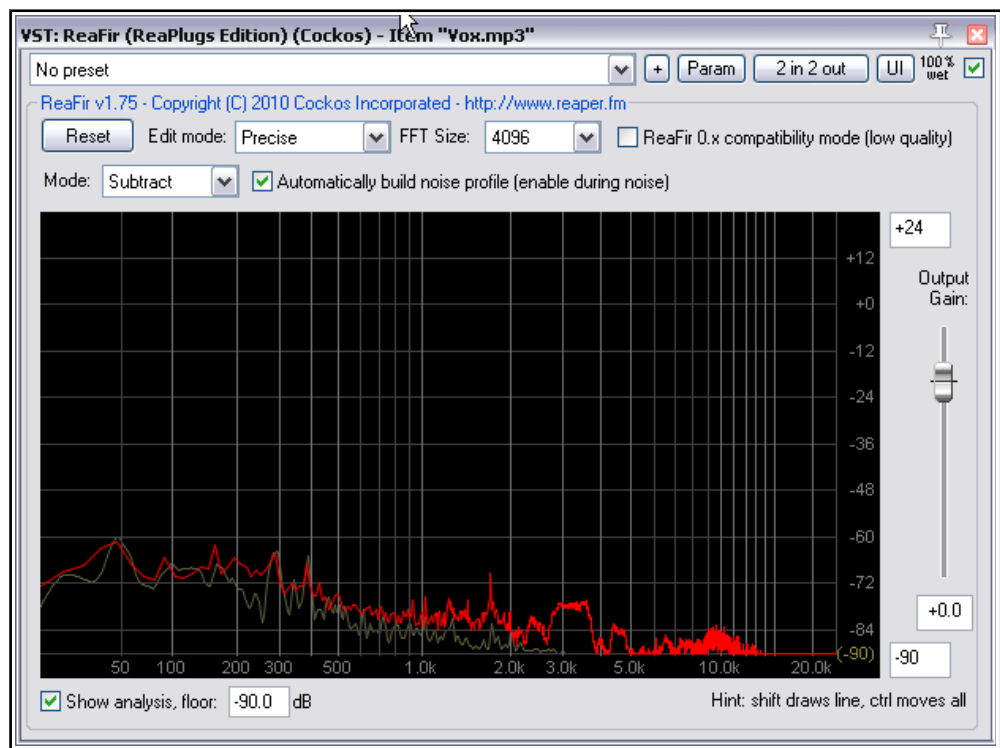

Note: You might be a little puzzled as to when to use a noise gate and when to use noise reduction software such as ReaFir. The answer is usually quite simple. Noise reduction is suitable for removing a background noise that is fairly constant, such as an electrical hum, whereas a noise gate is better at dealing with occasional noise, such as a vocalist's breathing sounds.

16.17 Multiband Compression with ReaXComp

Applied to the Master, Multiband Compression can be a useful tool for adding body, warmth and volume to your final mix. It is outside the scope of this guide to suggest just how heavily or lightly you should apply your Multiband Compressor. Many audio engineers believe quite strongly that the contemporary trend being currently pursued by the major record companies takes multiband compression too far.

Be that as it may, a multiband compressor works by applying different rates of compression to different frequency bands. This lets you shape the sound much more precisely than is possible with a simple compressor.

The ReaXComp default settings include 4 bands. These are 0 to 200 Hz, 200 Hz to 1,000 Hz, 1,000 Hz to 5,000 Hz and above 5,000 Hz. However you can add extra bands or delete superfluous ones. You can also change the band frequencies as you wish. For example, if you increase the top frequency of Band 1 to, say, 250 Hz, then that automatically becomes also the starting frequency for Band 2.

If you have not used a Multiband Compressor before, then you are advised to start cautiously and become more adventurous as you gain in knowledge and confidence. You can experiment on any of the sample **All Through The Night** project files that you have used elsewhere in this User Guide.

Example

1. Open one of your sample project files.
2. Insert **ReaXComp** in the FX window for the Master.
3. Play your project from the beginning.
4. It is quite likely that at this stage ReaXComp will have no effect on the sound. This will be the case if, as shown right, the peak levels (green vertical bars) fall short of the threshold settings (red horizontal lines) for each band (see example above) But you can still learn something!
5. Enable the **Solo current band** feature.
6. As the song plays, select in turn each of the four tabs, 1, 2, 3 and 4. This will enable you to hear separately each of the frequency ranges that you are working on.
7. Now disable the **Solo Current Band** feature. Disable **Auto makeup gain**. This will need to be done individually for each of the four band. If **Auto makeup gain** were to be left enabled, the volume of our mix would be pumped up after we make our other changes.

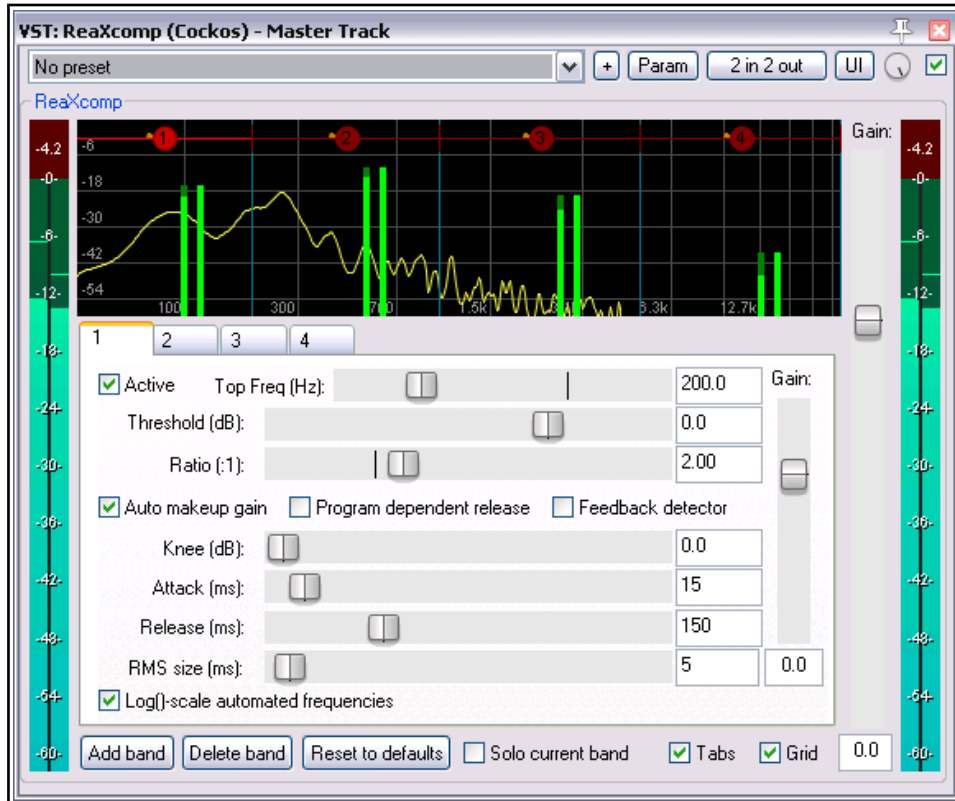

8. As the song plays, adjust the threshold for each of the bands until they come just below the peaks for each band. An example of this is shown here.

9. The default Ratio setting of 2:1 is quite a "safe" level. Try increasing the ratio for each of your thresholds up to around 4:1. If you find this makes the sound too compressed, ease the levels back towards 2:1. Remember, this is an example, not a model!

10. Even now, with these fairly conservative settings, you should notice the difference with ReaXComp enabled and set to bypass. When enabled, the different tracks should bind together better into a mix.

11. If you wish, you can experiment with the various other controls, especially the **Knee**. This setting determines how suddenly or gradually the compression is applied.

12. You can also experiment with the **Gain** controls if you wish, both for individual bands and for your overall mix, but don't overdo it.

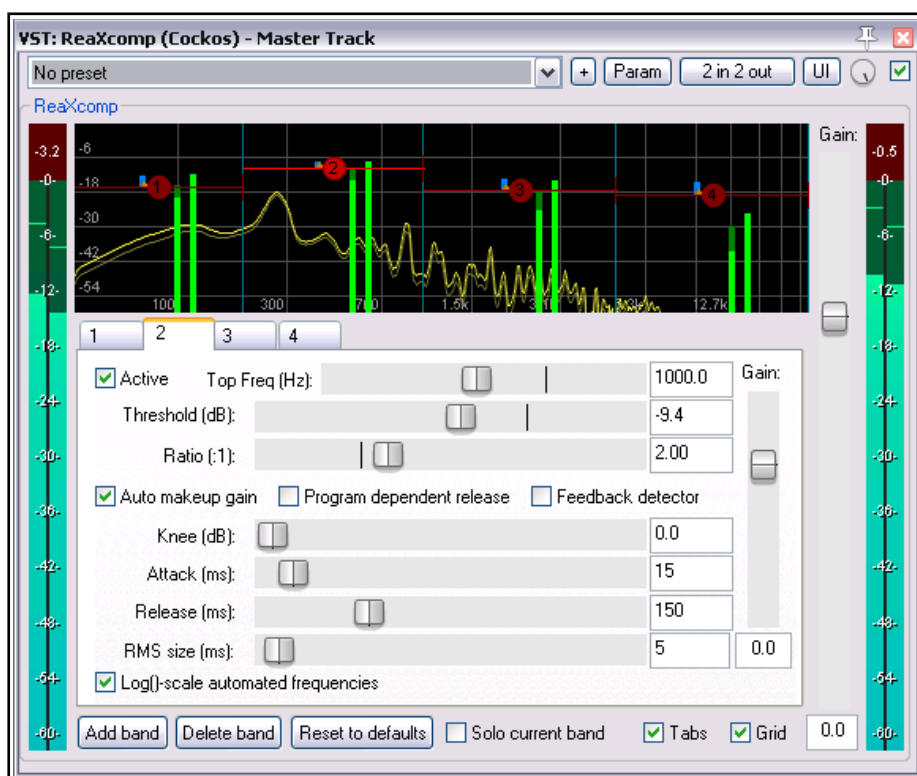

Using ReaXComp: Some Tips

- Don't use too many bands. Too many independently compressed bands can make your mix sound disjointed. Many of the best mastering engineers use only as few as three bands.
- Listen closely to the changes in sound as you adjust the various settings. One affects the other, so it is important to take your time here.
- The Attack settings determine how much time passes after the signal rises above the threshold before the compressor kicks in.
- The Releases settings determine how much time passes after the signal falls back below the threshold before the compressor is released.
- Try to adjust the Attack and Release settings so as to make the compressor come in and out unnoticed.
- Especially when first using a Multiband Compressor in the Master, it is advisable to use the Gain settings only to compensate for loss of volume due to compression, not to pump the signal up. A notable exception here might be where one bandwidth needs to be adjusted slightly relative to the others.
- It is often advisable to place a limiter (such as LOSER's Master Limiter) after the Multiband Compressor in your FX Chain.
- Another, and completely, separate use for a Multiband Compressor is to compress a very specific frequency within a track, for example as a de-esser or de-popper on a vocal track.

16.18 JS: Time Difference Pan

Of the many JS plug-ins that are supplied with (or available for use with) REAPER, the Time Difference Pan definitely merits a mention. It is simple to use, but very effective.

Sometimes you may feel that a track you have recorded sounds rather "thin" or "wimpish". You'll want to fill it out a bit, or fatten it up to make it sound richer, warmer, fuller. One old trick is to duplicate the track and run the duplicate track a few ms behind the original, but panned differently. Fed back into the main mix, this can almost make the one instrument sound like two instruments at times.

The TimeDifference Pan plug-in effectively does all this for you – with much less time and trouble on your part, and with very, very little CPU overhead. If you want to experiment with this plug-in to try out the effect for itself, the **Bouzouki** track on **All Through The Night.RPP** lends itself to this quite well.

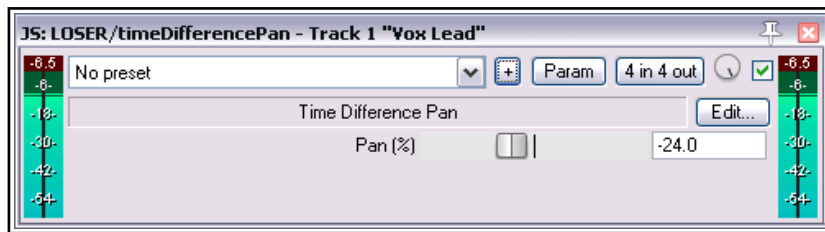

16.19 JS: Exciter

The JS Exciter plug-in is a simple way of putting some high end sparkle back into an otherwise possibly dull mix

Problems with individual instruments should be fixed on their own tracks. However, you might still wish to add some vitality to the overall mix Place the

Exciter at or near the beginning of the Master FX chain and see for yourself. Note these parameters:

Frequency – the frequency above which you want to add the sparkle. Try experimenting in a range of about 2000 Hz to 4500 Hz. Sometimes, you may need to go even higher for the best results.

Clip Boost – the amount by which you wish to boost the volume above this frequency. Be gentle at first.

Harmonics – the amount of Harmonics you want to add to the mix (go easy on this one).

Another plug-in in a similar vein is the **JS: Exciter (treble enhancer)**.

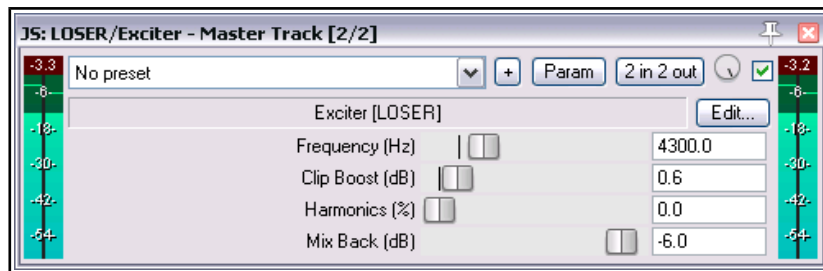

16.20 JS: Huge Booty Bass Enhancer

This is a simple plug-in that can be used to enhance the bass frequencies on any track.

Try setting the required frequency first, then gradually increasing drive and mix until you like what you hear.



16.21 Some Unusual JS Plug-ins

16.21.1 Utility/bufsave

Placed as the first FX chain item (or, for MIDI tracks, immediately after the synth) and at the end of the chain, this adds feedback to the chain (see example below). Up to 100 buffer slots are available. Use the same slot for both instances of bufsave on the same track, and do not use that same slot number on any other track.

The FX In between the two instances of bufsave could be a solitary simple effect (such as a simple delay, or remaincalm's floaty delay) or, as shown here, a whole sequence of effects.

The other four faders manage the audio flow. They determine separately for each bufsave instance the levels of source to buffer mix, buffer to buffer mix, buffer to

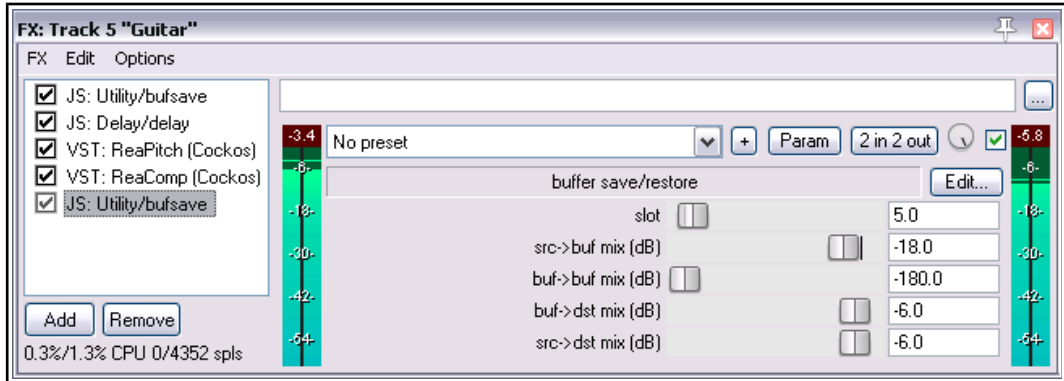

destination mix and source to destination mix. In particular, source to buffer mix acts as a feedback control. When working with feedback, be cautious. As a precaution, initially set both source to buffer mix faders some way to the left. You can then slowly fade these up more as required.

Interesting sounds can be obtained using more than one pair of bufsave plug-ins in an FX chain, with each pair being allocated its own unique slot.

16.21.2 JS: Thunderkick

This one can be positively scary! It adds a bottom end thunder-like sound to a track. You could try using it on a bass drum, or a synth or even an electric bass ... or anywhere where you want to create that atmosphere.

Its four faders are quite easy to work with. You'll likely get the best results without too much experimenting.

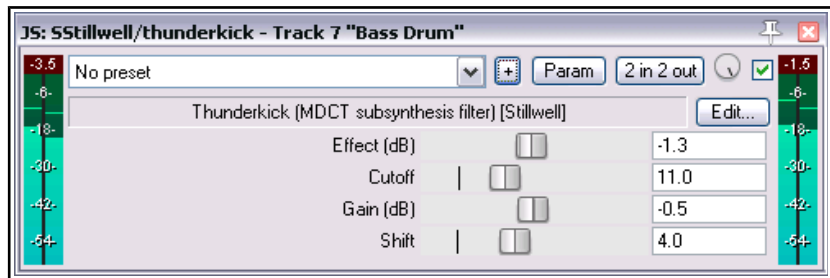

16.21.3 JS: Tonegate

Tonegate is a tone generator triggered off a gate, to add sine, square or noise tones. It is made more interesting by the addition of pitch and fade in/fadeout controls. This plug-in really gives you plenty of opportunity to be creative.

Originally intended for use with kick or snare, it is remarkably versatile. Try it out on your electric guitar, for example.!

Experiment at first with the **Frequency** fader and the **Waveform** options, then let your ears be your guide as you adjust the other controls.

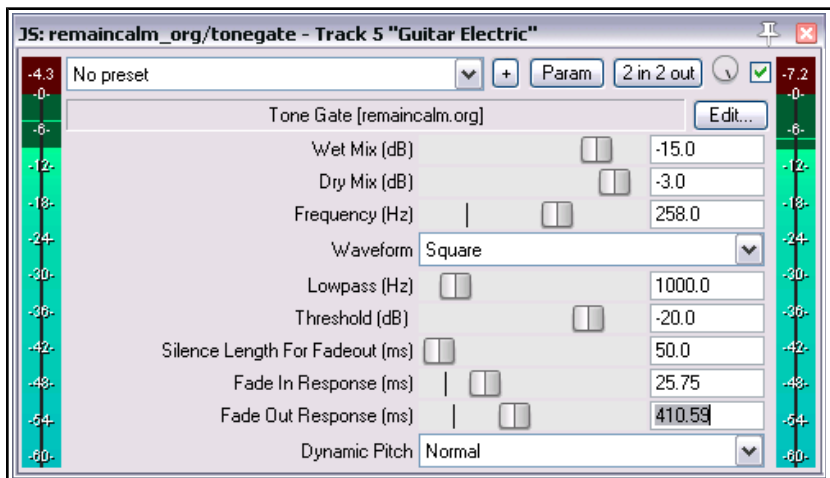

You can learn more about this and other great remaincalm JS plugins by visiting remaincalm.org.

Up and Running: A REAPER User Guide v 5.24

16.22 Some Guitar FX Plug-ins

There's a whole series of Jesusonic plug-ins especially designed to help you shape your guitar sounds. By and large, they work in much the same way as your guitar pedals do. Here is a selection:

Plug In	Description
JS Convolution Amp/Cab Modeler JS Convolution Dual Amp modeler	Lets you select an amplifier to be simulated, such as a Fender or a Marshall. Lots of parameters for you to tweak! The dual version of this plug-in lets you choose different left-right speakers!
JS Chorus	The waveform is fed thru a series of delays whose delay times are slowly modulated. The shape of the chorus sound is moulded primarily by the Length, Number of Voices, and Rate settings.
JS Distortion	This plug-in works by distorting the shape and frequency content of the waveform. The degree of distortion applied is determined principally by the Gain and Hardness settings.
JS Flanger	Flanging is produced when a signal is mixed with a delayed copy of itself, while the delay time continually changes. The flange effect is set by adjusting the Delay Length, Rate and Feedback parameters.
JS 4-Tap Phaser	This four allpass filter stereo phaser effect settings include Rate (Hz), Range (Min and Max), and Feedback.
JS Wah-Wah	The wah effect is a filter effect, produced by the Position, Top Resonance, Bottom Resonance and Filter Distortion settings.
JS Tremolo	Tremelo is produced by low-frequency variation in a sound's amplitude envelope, achieved by setting Frequency (Hz) and Amount (dB).

It is not suggested that you will want to use all these effects at once, but if you do use more than one of these, then the effect is cumulative. The order in which you apply them will determine how the output sounds. As a starting point, one possible order is shown on the right.



This does not mean that you shouldn't hold back from experimenting with other FX ordering, to see what creative sounds you can produce!

Filter (e.g. Wah or Phaser)
Compressor
Distortion
EQ
Pitch Change (e.g. Vibrato)
Modulator (e.g. Flange or Chorus)
Level Controller (e.g. Tremelo or Limiter)
Echo (such as Reverb)

16.23 Some Other REAPER JS Plug-ins

This next part of this chapter will give you an overview of some of the other wonderful Jesusonic plug-ins supplied with REAPER. It is only a small selection, and the fact that any plug-in isn't included in this table in no way implies that it is inferior to any of those that are included.

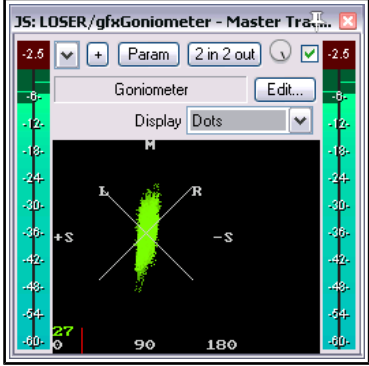
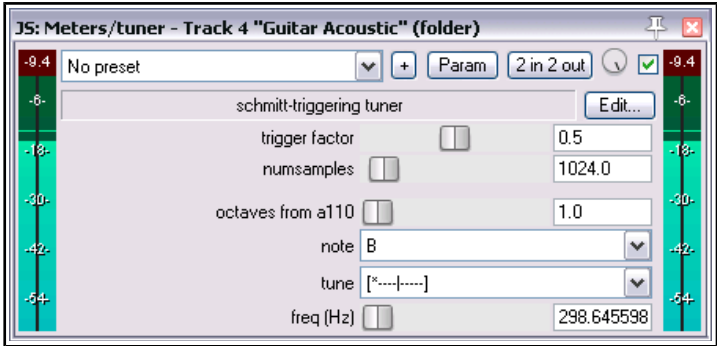
Plug In	Description
JS Channel Polarity Control	Four choices, Normal Phase, Invert Left, Invert Right or Invert Both.
JS Channel Router w/Polarity	A stereo phase inverter with the addition of selectable input and output channels. This can be used, for example, to create a fuller, more vibrant sound from a single mono track.
JS Digital Drum Compressor	A custom designed compressor suitable for use with Digital Drums.
JS LOSER/Simple Peak-1 Limiter	A simple peak limiter with a single control, Threshold. This can be used to prevent an individual track from clipping.

Plug In	Description
<p>JS Goniometer</p>	<p>Place it at or near the end of the FX chain of a stereo track, folder, or the Master</p> <p>You will see a visual representation of the movement of the sound within the stereo field.</p> 
<p>JS Stereo Enhancer</p>	<p>Used to create an enhanced stereo effect in a stereo track, folder, bus or Master. Works by adjusting the width panning of high and low frequencies independently, and to define the crossover point between the two.</p> <p>Other JS stereo manipulation plug-ins include MDA Pseudo Stereo and Stereo Width.</p>
<p>JS Waveshaping Distortion</p>	<p>A delightfully easy to use plug-in that adds distortion to a track.</p>
<p>JS Meters/tuner</p>	<p>Insert this into a new track and arm for recording, then tune your guitar.</p> 
<p>JS Meters/vumeter</p>	<p>Insert this into any track when you want monitor its VU levels closely.</p>
<p>JS Tonifier</p>	<p>An interesting plug-in that creates sound effects by shifting pitch or frequency for audio blocks of a determined size.</p>
<p>JS Ozzifier Chorus</p>	<p>Especially good for fattening or doubling a vocal track.</p> 
<p>JS Downward Expander</p>	<p>The opposite of a compressor! Can restore dynamics to a mix that sounds overcompressed. This works by <i>further attenuating</i> the volume of the signal when it falls <i>below</i> a given threshold.</p>

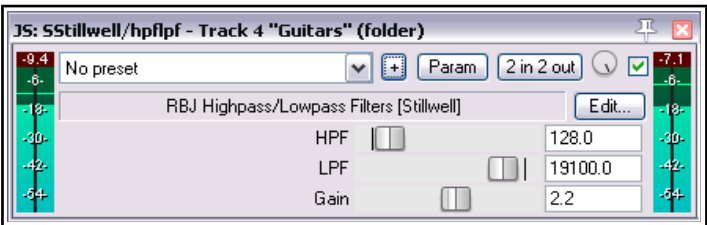
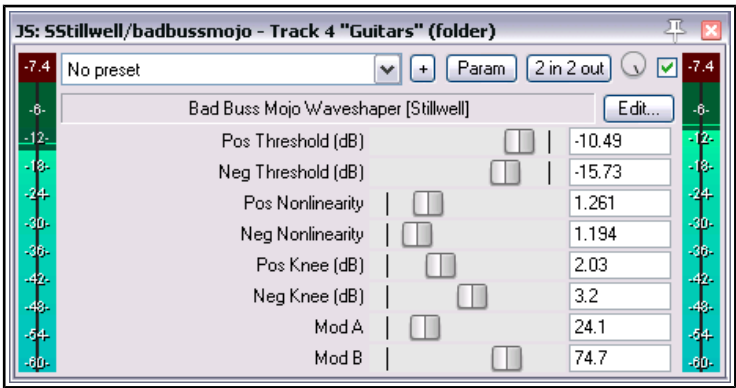
Plug In	Description
JS RBJ Highpass/Lowpass	<p>Adds a high pass filter and low pass filter to a track or Master. Useful, for example, for removing bottom end rumble.</p> 
JS Bad Buss Mojo Waveshaper	<p>A nonlinear waveshaper with a difference.</p>  <p>Use in particular the nonlinearity, knee and mod settings to make a piece sound a little less perfect and a little more "rootsy" and authentic.</p>
JS Louderizer	A simple plug-in with two controls, used to make a track or mix louder.
JS Pitch Shifter 2	One of a number of plug-ins that can be used to change pitch.
JS FFT Peak-Following Filter	A neat plug-in that lets you create autowah type effects, essentially by adjusting center frequencies and filter width. The closer together are the values of the min and max center frequency and the lower the octave width setting, the more dramatic will be the effect.
JS DC Filter	A DC offset removal plug-in.
JS Volume Adjustment	A simple plug-in that increases or attenuates volume. Place it at the start of an FX chain to adjust track or item volume before FX are applied.
JS Phase Rotator	Another very simple plug-in, used to adjust the phase of a track or item.

Over 200 Jesusonic plug-ins are supplied with REAPER. Hopefully, this chapter has given you more than a few good pointers, but it is not possible to document them all in this User Guide. For more information check out REAPER's Wiki – go to wiki.cockos.com/wiki/index.php/Category:Jesusonic,

16.24 Controlling FX Parameters on the Fly

If you have a controller such as (but by no means necessarily) a Presonus Faderport, you can assign a control on the fly to a VST FX parameter. Just do this:

- ◆ In the Action List, find the action **Adjust last touch FX parameter**.
- ◆ In the **Shortcuts for selected action** panel, click **Add**.
- ◆ Twiddle the required knob on your controller.
- ◆ Set other actions as required and Click **OK**.

16.25 Bridging and VST Plug-in Run Mode

If you are running the 64-bit version of REAPER and wish to use older 32 bit plug-ins you will need to use bridging. By default, REAPER will attempt to work out for any plug-in that you use whether this bridging is required (Options, Preferences, Plug-ins, Compatibility). However, for any plug-in you can override this setting by right-clicking over the plug-in in the FX browser and choosing from the context menu Run as, and selecting one of three options which allow you to specify just how a plug-in is to be bridged. These options are:

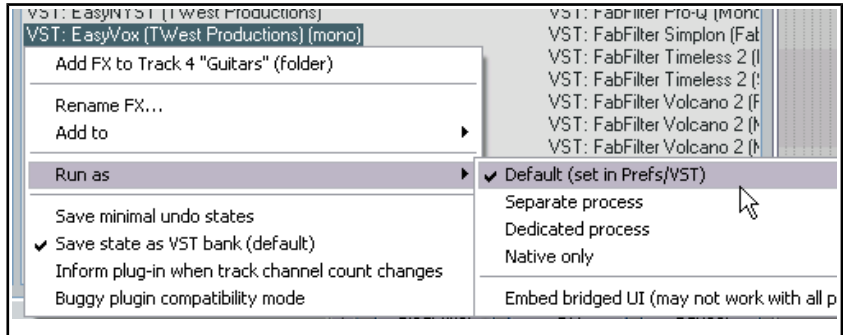

Separate process: all bridged plug-ins for which this option is

selected will be put into a single process, external to the main Reaper process. This has the advantage of minimising the resulting CPU load, but also carries a significant disadvantage: if one plugin is buggy and crashes the bridge process, all the other bridged plugins will die too.

Dedicated process: this puts each bridged plugin into a separate bridge process of its own. This will prevent a buggy plug-in from crashing the entire bridge, but it has the downside of increasing the overall CPU load.

Native only: is the default; the plug-ins are run inside the main Reaper process.

Bridging can serve another useful function. Even though it is primarily intended for use with 32 bit plug-ins, you can if you wish also bridge (most likely in a dedicated process) any 64-bit plug-in. This has the effect of firewalling REAPER against any adverse effects that could potentially arise from a buggy 64-bit plug-in.

A further choice, **Embed bridge UI**, determines whether the bridged plug-in GUI is displayed in the FX Chain wrapper window (or as a floating window) or is displayed in a completely separate (Windows / OSX) window. The choice is provided as some bridged plug-ins behave better in one context than in the other.

Remember! You should not store 32 bit plug-ins in the same directory as 64-bit plug-ins.

16.26 Third Party Plug-in Presets

You can use your favourite third party VST and DirectX plug-ins with REAPER, such as Sonitus, Wave Arts, Sony, and so on. Many of these plug-ins are supplied with a number of Presets. The method of accessing these will vary depending on such factors as the plug-in's native interface and which type of plug-in it is. In this section, we will look at three examples. Armed with this information, you should be able to figure out where to find the presets for any of your plug-ins.

Example 1

This example is of a popular DirectX Sonitus plug-in, Phase. In this case, the plug-in interface includes its own native **Presets** section. Clicking on that (shown above) displays a menu of supplied presets. You can also store your own presets here if you wish, as the Sonitus range of plug-ins includes its own preset manager.

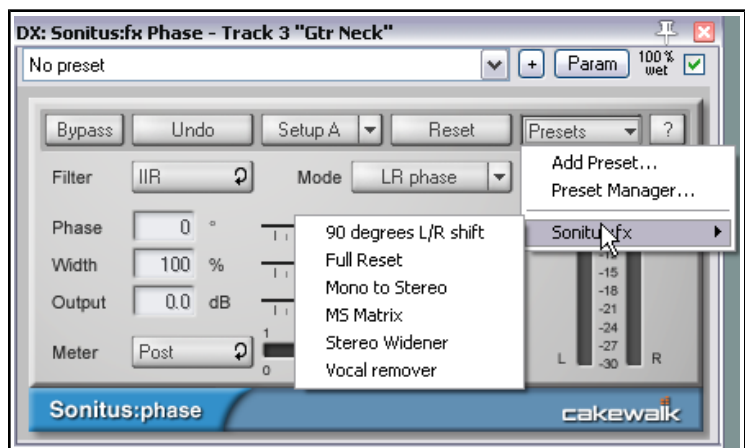

Notice that you can also use REAPER's own Preset Library to store your presets with REAPER rather than with the plug-in. This is accessed by clicking on the small + button shown just to the left of the Param button. This is especially useful when you are working with plug-ins that might not have their own native Preset Manager.

Example 2 (right)

This example shows a TWest VST plug-in, STEADY Pro.

This plug-in does not have its own native preset manager. However, as with other plug-ins you can use the REAPER VST program interface to create and manage your own presets.

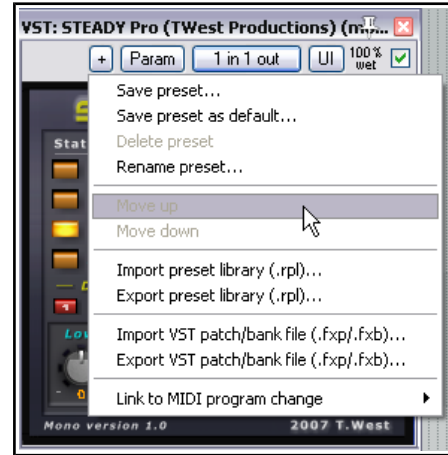

Example 3 (left)

A Direct X plug-in this time, Sony's Vibrato.

In this case, native presets do not appear when clicking on the REAPER Preset drop down arrow. This will only display any presets that you have created yourself.

In this example, right-click over any vacant area of the plug-in's GUI interface to display a list of factory presets.

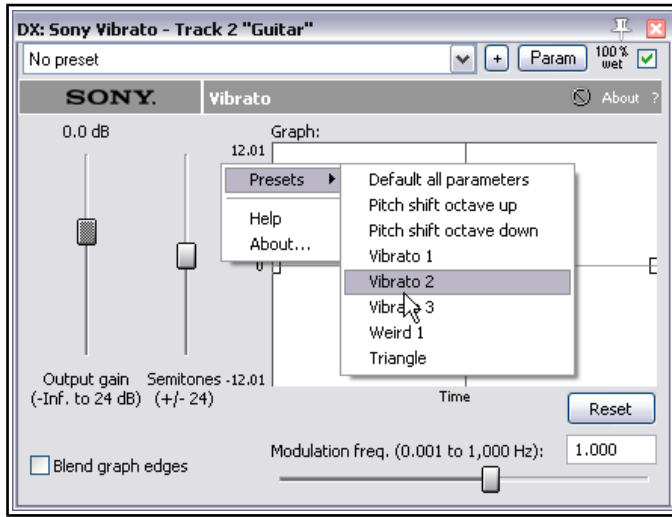

16.27 Losing the Graphic User Interface (GUI)

There might be times when you might want to lose a VST plug-in's graphical user interface (GUI) and instead display its parameters as a simple series of faders. This is when the **UI** button in REAPER's plug-in interface comes in. Clicking this button causes the plug-in and its various controls to be displayed in a simpler format.

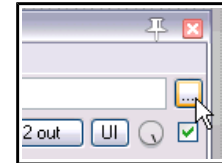

Here's an example, using the Terry West VST Voc-EQ PRO ST plug-in. You might like this plug-in, but perhaps not its rotary controls. Some people find rotary controls quite difficult to control with a mouse.

In that case, you might want to click the plug-in's **UI** button (see position of mouse cursor), and turn that graphical interface into this:

In REAPER's generic interface, every parameter is controlled by a horizontal fader.

There is also an option on the **Plug-ins, VST** page of your preferences settings to **Default VST to generic UI (instead of plug-in UI)**.



17 More REAPER Routing Examples

This section is mainly intended for reasonably experienced users of DAW software, to show you some of the more clever aspects of REAPER's routing that are probably different from anything you've experienced before. But hey, even if you're a complete newb, you might like to have a look anyway. You might find it interesting ... or you might prefer to skip past it for now and come back to this chapter later.

Note: Some of the screen shots used in this chapter use the REAPER 4 default theme. The actions and steps required for the examples, however, are exactly the same in REAPER 5. In addition, the default REAPER 5 theme sports an additional feature on the TCP's track routing button. This displays for each track one, two or three small "lights" each of which will be on or off. The first of these indicates whether the master/parent send option is enabled; the second whether that the track has one or more receives; the third (as shown here) whether that the track has one or more sends. Hover the mouse over the button for a tooltip.



17.1 Controlled Bleed

Bleed is a term used when material intended to be recorded on to one track manages to overflow onto others. This commonly happens:

- When more than one voice or instrument is recorded at the same time, each with its own microphone. For example, you might record a person singing and playing an acoustic guitar at the same time, perhaps one vocal mike, one guitar mike. However, you will find that some of the vocal will bleed on to the guitar mike, and vice versa.
- With layered recording, when the headphones are so loud, or ill-fitting, that the microphone being used for recording actually picks up some of the output of the headphones.

Headphone bleed is bad, period. If, for example, you have an artist who likes to hold one headphone to her ear while overdubbing a vocal, then make sure the mix is sent to that ear only. Happily, REAPER's flexible routing makes this simple.



In the example shown (right), output from the Master is directed to both Speakers, but only one headphone.

The other kind of bleed, which we will call *live recording bleed*, can actually have some benefits. If all microphones are positioned carefully and correctly, it can produce a warmer, fuller more natural sound than is often obtainable from layered recording. (Layered recording is where each track is recorded one at a time). The trouble is, the "all at once" method of recording it also has negatives – serious ones. For example:

- It isn't possible to drop in and overdub a short passage to correct perhaps a vocal phrase or a couple of bars on the guitar. Basically, the whole track has to be recorded again each time. Everything.
- Your mixing options are restricted. For example, if you need to add some presence or compression to the vocal track, then you will also be adding it to the guitar bleed in the same track.

This is where REAPER's routing capabilities can be so useful. They allow you have the best of both worlds – the richer, fuller sound that you can get from adding a small amount of controlled bleed, but without the disadvantages. Here's how it works:

- Use layered recording, to ensure that each track is recorded cleanly.
- Use REAPER's routing to add a little bleed where you want it, before or after any FX in the FX chain.

Example

This example demonstrates a simple use of routing to create a *controlled bleed* effect.

1. Open the file **All Through The Night.RPP** and save it as **All Through The Night BLEED.RPP**
2. Mute the **Bouzouki** track. To keep this example simple, we won't be using it here.
3. Select the **Vox** track, right click over the Volume control and set the number of track channels to four.

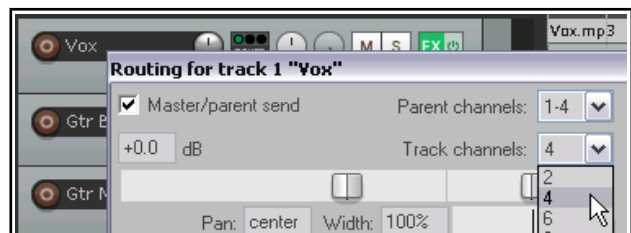

4. Display the **FX Window** for the **Vox** track. Add a Reverb FX of your choice. In this example, we are using **ReaVerbate** which is included with REAPER.
5. After inserting the ReaVerbate plug-in (or whatever you are using), adjust its settings to suit. Click on its 2 in 2 out button and use its pin connector to direct output to Channels 3 and 4 only (see right).
6. Display the routing window for the Vox track. Add **Sends** from the Vox (stereo source Channels 3/4) to both Guitar tracks (channels 1/2), as shown below. Pan these at about 70% left and 70% right respectively, about -15dB , and Post FX. This ensures that the vocal track will be heard crisply and cleanly from the center, whilst its reverb is directed more to the left and right.
7. Play the song, with the Vox track Master/Parent send disabled. Adjust the Send levels of Vox to both Guitar Tracks so that the Vox can only just be discerned in the very background.
8. Enable the Master/Parent send on the Vox and play again. You may need to tweak some reverb parameters and/or send levels. The Vox should sound fuller and richer than before.
9. Save the file.

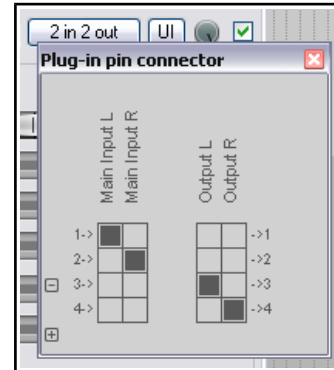

Now try this!

Remove the Reverb FX from the vocal track.
 Remove the sends from the **Vocal** Track to the **Guitar** Tracks.
 Create a new track called **Vox Reverb** and insert a Reverb FX of your choice.
 Create a send from your **Vox** track to this **Vox Reverb** track.
 Create sends from the **Vox Reverb** track to both **Guitar** tracks, Post FX.
 Play the song, adjusting Send, Pan and Volume levels to suit.
 Disable the master/parent send of the Reverb track – you should notice a significant difference.

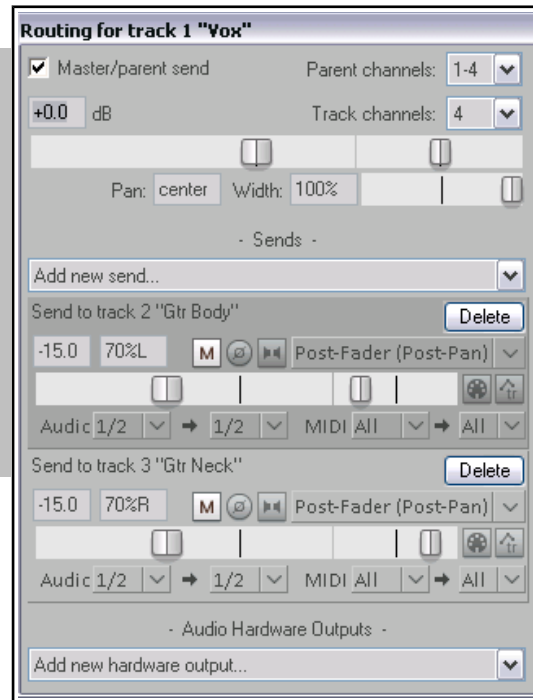

17.2 Splitting Channels

This example will introduce you to a feature in REAPER that possibly delivers you more mixing power than any other single aspect: the ability to create and use multiple channels. Doesn't sound very interesting or exciting does it? It's not an easy concept to understand at first, so, just for fun, we'll take as simple an example as we can to introduce the concept.

You have an acoustic guitar track recorded. You should by now have a general idea at least about how to shape its sound with EQ, or fatten it with a little delay. But in this example, we're going to take it to another level: we can split the recorded track by different frequency bands into, say, three different paired channels, and perhaps pan different frequencies differently, or add some trailing delay just to one channel (i.e., one selected frequency range).

Why would you want to do this? With this particular example, maybe you would, maybe you wouldn't. But being able to create and use channels in this way opens up many creative mixing and editing possibilities. We'll start with this example because it's a fairly simple one to put into practise. After that, we'll look at a more complex case.



Example

1. Open the file **All Through The Night.RPP** and save it as **All Through The Night Channels.RPP**
2. We are (for the purpose of this example) going to work only with the track **Gtr Body**. **Mute** all other tracks except this. To do this, hold the **Alt** key and click on the **Mute** button for this track.
3. We now are going to create three tracks – let's call them *Ghost Tracks* – to mirror each of the three bands that we are going to split our **Gtr Body** track into. Create these three tracks and label them **Low**, **Medium**, and **High**. See illustration on right.
4. Display the **routing window** for the **Gtr Body** track. Set the number of **Channels** (near the top) to **6**, and create sends to each of the three tracks that you have just created.
5. Send Audio from **Channels 1/2 to 1/2** on the **Low** track, **Channels 3/4 to 1/2** on the **Medium** track, and **Channels 5/6 to 1/2** on the **High** track (see illustration right).
6. Getting complicated? Then make sure that your **Routing Matrix** is in view.
7. Now open the FX window for the **Gtr Body** track and insert the **JS LOSER/3BandSplitter**.
8. Set the first frequency fader to about 200 Hz and the second to about 2000 Hz.
9. Solo the **Low** track and play. Notice you hear only the Low frequencies.
10. Hold **Ctrl Alt** and click on the Solo button on the **Medium** track. Notice you hear only the Medium frequencies.
11. Hold **Ctrl Alt** and click on the Solo button on the High track. Notice you hear only the High frequencies.
12. Experiment adjusting the faders in the 3 Band Splitter and playing back. Notice how the sound changes. Set them back to their defaults afterwards.
13. Now select the **Medium** track, open its FX window and add **JS:Guitar/chorus**. Adjust the settings to suit.
14. Now unsolo any solo tracks, unmute any muted tracks to restore all tracks to your mix. You'll probably want to fade down the original Gtr Body track to about -6 dB and the Bouzouki to about -10 dB (or mute altogether).
15. Make any further adjustments you want to your **Delay Chorus** settings. An example (but only an example) is shown above.

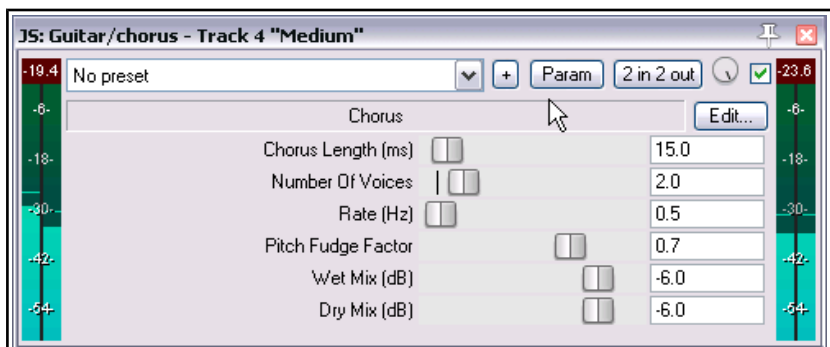
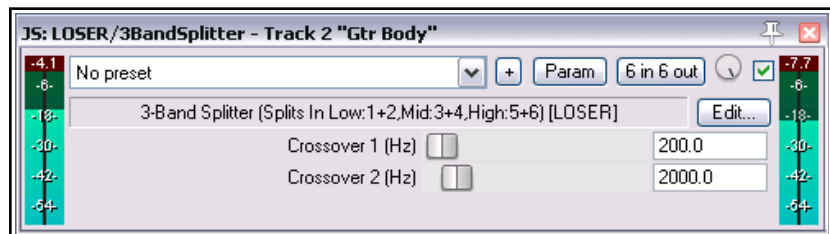
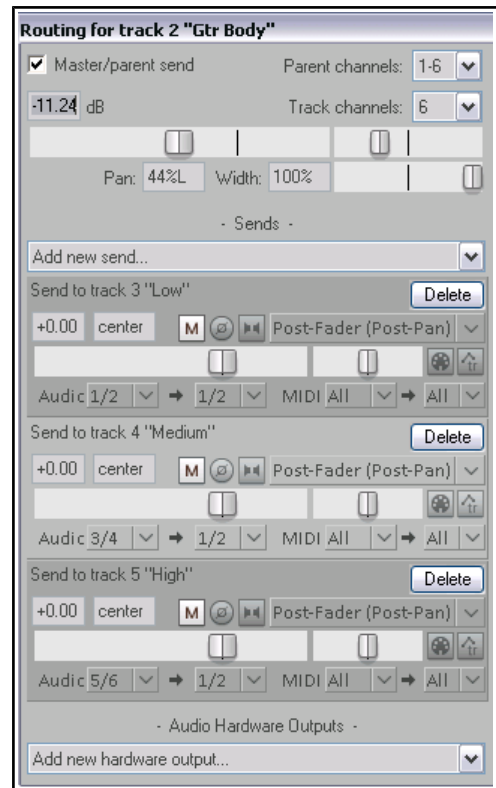

- Experiment with panning the three bands differently, to create a fuller sound.
- Save this file.

The plug-ins supplied with REAPER include several which can be used for channel manipulation, including a four band splitter (shown here) and a five band splitter.

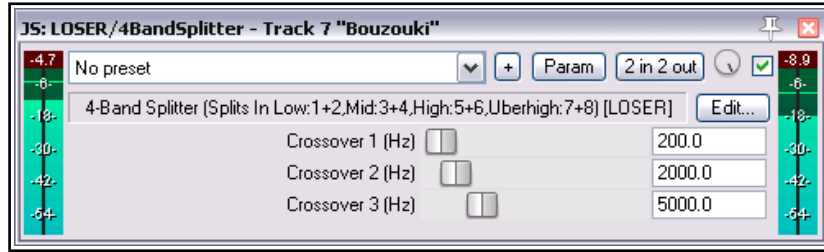

17.3 Full and Fat Vocals with ReaDelay

This next example shows how you can combine REAPER's channel splitting capabilities with the ReaDelay plug-in to create a simple effect for fattening up thin vocals – all on a single track! The flow chart on the right illustrates how this will be done. The signal flow shown has this effect:

- It creates a sidechain which is fed into the ReaDelay plug-in to fatten the original sound and to fill it out.
- It uses ReaComp to apply some compression to the main vocal.
- The delayed signals are then mixed back in with the original signal. Further compression is then applied.

if you wish, you could apply more FX to any of:

- The original dry recording.
- The sidechained and delayed signal.
- The final mix of the dry and sidechained (delayed) signals together.

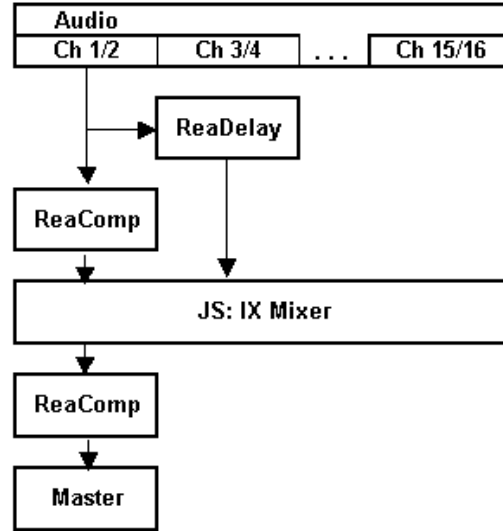

Note that the order of the plug-ins in the FX chain is significant: if you change the order, you change the outcome! This issue will be examined again more closely in later examples.

Example

- Open the file **All Through The Night.RPP** and save it as **All Through The Night READELAY.rpp**.
- Solo the **Vox** track. For the purpose of this example, we will be working with the vocal track alone.
- Display the routing window for this track and set the number of track channels to **4**.
- Open the **FX Window** for this track. If there are any plug-ins already in the chain, remove them.
- Now insert **ReaDelay** into the FX chain.
- Click on the **2 In 2 Out** button to display the connector matrix. Leave the **Inputs** at their default (Channels 1 and 2), but adjust the **Outputs** so that they are **Channel 3** (Left) and **Channel 4** (Right), and *only* these two channels (as shown above).
- Click on the **Add Tap** button to add a second page.
- Set Page 1 to a Delay Length (time) of about 3.5 ms and musical length 0.
- Set Page 1 Pan to about 50% Left. This shows on the fader as -0.5. See the illustration below.
- Set Page 2 to a Delay Length (time) of about 6ms or 7 ms and musical length 0.
- Set Page 2 Pan to about 50% Right. This shows on the fader as 0.5.
- Make sure that both pages are **Enabled** and that neither is soloed.

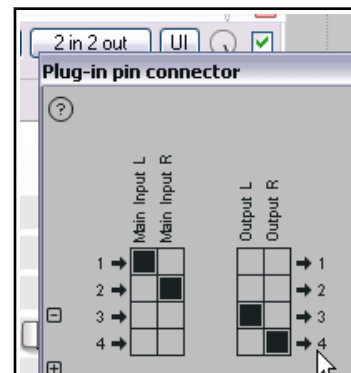

13. Set the **Wet** level to about -9 dB and the **Dry** to about -2 dB. Because we have not yet added a channel mixer you will not yet hear the delay effect.
14. Insert **ReaComp** into the FX Chain. Leave the Main Inputs and Outputs both at their default settings, which are Channel 1 (Left) and Channel 2 (Right).
15. Set the **Ratio** to about **6:1**. Adjust the **Threshold** so that for louder passages **Output** is reduced by about 6 or 7 dB.
16. We can now join our channels back together again, to mix the delayed signal with the compressed signal. Insert the **JS:IX/Mixer_8xS_1xS** into the FX chain (after ReaComp).
17. Fade all but the first two faders all the way down; adjust the other two faders as you wish (see right).
18. Add another instance of **ReaComp** after the mixer. Adjust settings to suit.
19. Play the file, adjusting the track volume faders to suit your ears. Compare the vocal sound with FX alternately enabled and bypassed. With these FX enabled, the vocal should sit above the mix rather more easily.

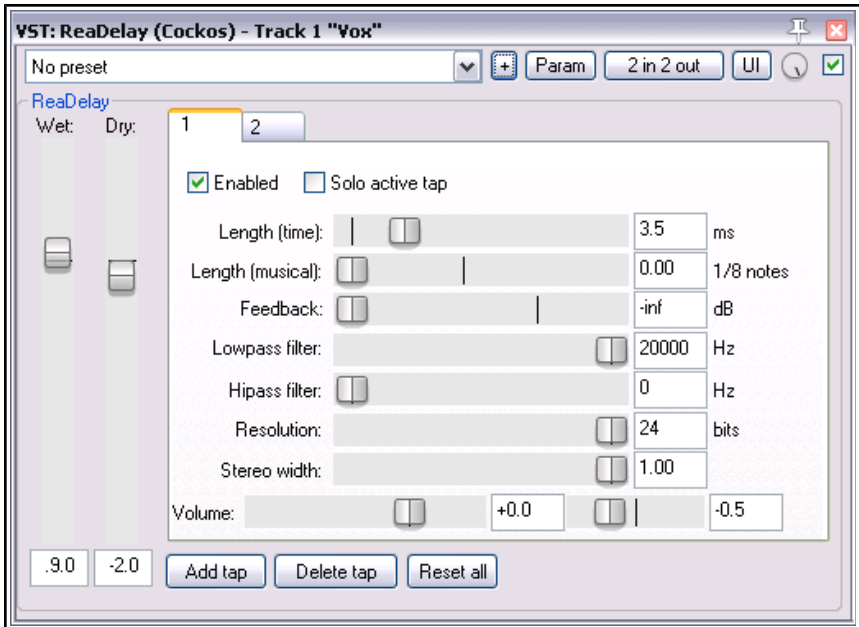

Note: In this example, the order in which the FX are applied is significant. With the order that we have used, the sidechained (delayed) signals do not go thru the compressor, with the result that these signals retain more of their original dynamics.

17.4 REAPER Send Types

Every send is defined as being one of three types - **Post-Fader (Post-Pan)**, **Pre-Fader (Post-FX)**, or **Pre-FX**. The default type is **Post-Fader (Post-Pan)**, but this can be changed in your preferences if you wish (Track/Sends defaults page).

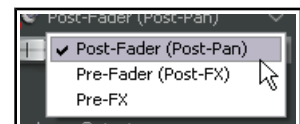

Different send types send the audio at different stages in the audio signal flow. For example, the volume of a send that is Post-Fader (Post-Pan) will be affected by changes made to the source track's volume fader. A send that is Pre-Fader (Post FX) will not. An audio send that is Pre-FX will not be affected by any FX in the source track's FX chain. For more complete information, consult the flow charts at the end of Chapter 6.

17.5 Channel Splitting and Pitch Shifting

You've already seen how ReaPitch can be used, for example, to create vocal harmonies from a lead vocal track. Now you will see how by splitting a vocal track into several channels you can create a whole vocal ensemble, with different FX and plug-ins being applied to different harmony parts.

This is especially useful, for example, if you want to compress your vocal harmonies before lowering them, to make them sit smoothly and subtly behind the lead vocal.

The illustration (right) demonstrates this concept.

In summary, this is what happens:

- The Vocal Track is assigned six channels.
- Two instances of ReaPitch are inserted, and the signal from channels 1 and 2 is fed to both of these.
- The output from the two ReaPitch instances are directed via channels 3 and 4 and 5 and 6 respectively to two separate instances of ReaComp.
- In each case, you will need to specify Channels 3 and 4 (ReaComp 1) and Channels 5 and 6 (ReaComp 2) as the input source for your compressors. Auxiliary Inputs should be set to nothing, and the Output channels should be the same as the Input Channels.
- The output of the two compressors is sent to a single instance of ReaEQ, as is the original signal on Channels 1 and 2. In order to do this, you should make Input 1 for ReaEQ Channels 1, 3 and 5 (see illustration right), and Input 2 should be Channels 2, 4 and 6.
- By sending the three different audio streams directly into ReaEQ we cut out the need for a channel mixer. However, in doing this it makes it more difficult to adjust the relative volume levels of the three audio streams. In this example, you could use separate instances of the JS utility Volume plug-in in each chain to do this.
- The three streams are joined back together at ReaEQ, from which they are fed to the volume fader and then to the Master.

This method can be employed, for example, when you wish to use more than the 16 channels that can be handled by any of the mixer plug-ins. You can in fact use up to 64 channels.

Again, the order in which FX are placed in the chain is important. One possible strategy is to insert them in reverse order of their channels, i.e. highest channel numbers first. The critical factor is to place those FX which both take their input from and direct their output to Channels 1/2 after any FX whose output is directed to sidechain channels (such as 3/4 or 5/6).

Tip: If you forget to create your required track channels before loading your plug-ins into a track's FX chain, then you can still add them "on the fly". To do this, just click on the small + button in the bottom left corner of the Plug-in Pin Connector window - see above.

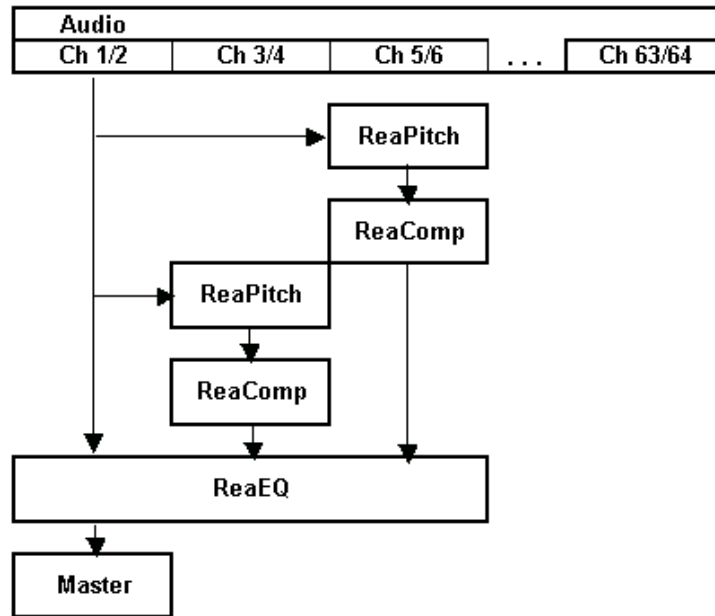

Note: Set auxiliary inputs in both ReaComp instances to none: use Main inputs to drive these compressors

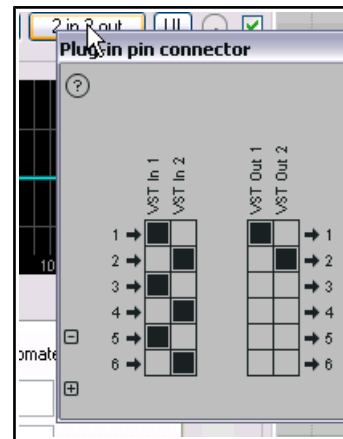

17.6 Audio Ducking

The next example will show you how to use a technique known as **sidechaining** to create an effect known as **ducking**. Put simply, this describes what happens when a compressor is set up to ensure that the volume on one track is automatically lowered whenever the volume on another track is raised.

You might want to do this, for example, when working with a kick and a bass. In this example, we'll use the Bouzouki, Guitar and Vocal tracks in our sample project to show you how it's done. We will use audio ducking to ensure that the overall volume of the instruments are automatically lowered slightly whenever there is a signal on the Vocal track. This helps lift the vocal track slightly above the mix. In order to do this, we use multi channel routing in conjunction with the ReaComp compressor.

This diagram (above right) illustrates the concept of how we use sidechaining to achieve our ducking effect. Let's take it step by step.

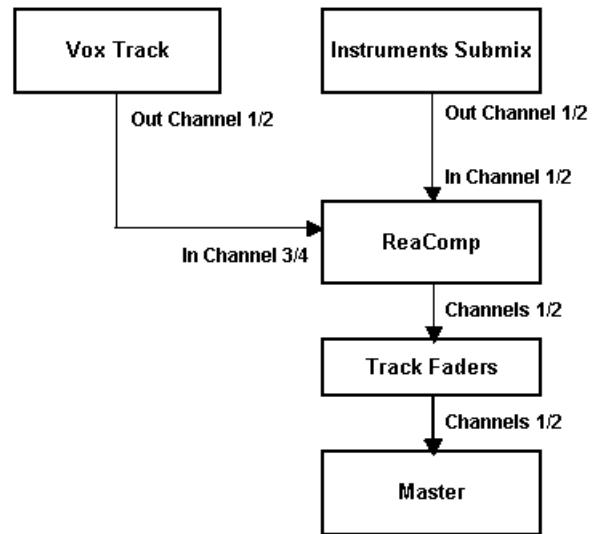

Example

1. Open the project **All Through The Night.RPP** and save it as **All Through The Night DUCK.RPP**.
2. If there are any tracks other than **Gtr Body, Gtr Neck, Vox** and **Bouzouki**, delete them, so that you are left with just these four tracks. Adjust the volume and pan faders of these tracks to get a reasonable mix.
3. If necessary, change track order so that Vox is Track 1, Gtr Body Track 2, Gtr Neck Track 3 and Bouzouki Track 4.
4. In the Track Control Panel, select the **Vox** track and press **Ctrl T** to insert a new track after this. Name this new track **Instrument Submix**.
5. Click on the **Folder** icon to make this track a folder. Make the Bouzouki track the last track in the folder.
6. We need to add two more channels to the **Instrument Submix** so that it can receive a sidechain signal from the Vox. Right click over the Volume fader for this track, then set the number of channels to four (as shown above right).
7. We need to create a sidechain to enable the various instrument and **Instrument Submix** track to detect the signal level of the **Vox** track. Drag and drop from the **ROUTE** button on the Vox track to the **ROUTE** button on the Instrument submix. This will create a send and open the controls window for that send. Accept the default send type Post Fader, Post Pan) and set the destination channels to 3/4 (as shown right).
8. Next, display the FX window for the Instrument Submix Track. Add the **Cockos** plug-in **VST: ReaComp (Cockos)**.

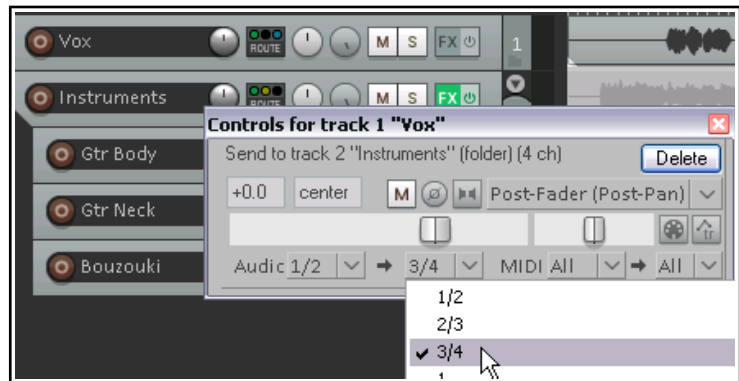
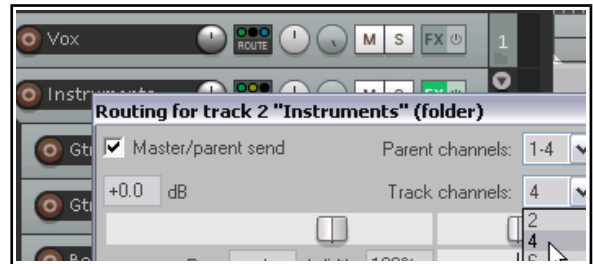

Up and Running: A REAPER User Guide v 5.24

- This plug-in includes a setting called **Detector input**. This is where we tell REAPER that we want the Vox level, not the Bouzouki level to control when the compressor kicks in. This Detector input offers two basic choices – **Main Input** and **Auxiliary Input**.
- We need to ensure that Main Input is defined as the media on the Submix track (Channels 1 and 2), and Auxiliary Input is defined as the stream coming from the Vox track on Channels 3 and 4.
- Click on the **4 In 2 Out** button and if they are not already set, set the assignments as Main Input L - Receive from Channel 1, Main Input R - Receive from Channel 2, Auxiliary Input L – Receive from Channel 3, and Auxiliary Input 4 – Receive from Channel 4. These are as shown on the right: most probably these will be the default settings.
- Now display the **Detector Input** drop down list and select **Auxiliary Input L + R** (below right). This ensures that the compression will be applied to the instrument mix in response to changes in the volume (strength) of the incoming signal on channels 3/4 from the vox track. When the volume of the vox exceeds the threshold setting, the instrument mix will be compressed.
- Now play the song. Adjust the **Threshold** (first vertical fader) downward, so that during Vocal passages the VU meter peaks above the fader level.
- Slide the **Ratio** fader right until you are satisfied with the overall amount of reduction on the Instruments. This will probably be somewhere between 4:1 and 6:1. Observe the flashing red bar to the left of the Output VU. This indicates the amount of reduction that is occurring on the submix track. In this example, this is -2.5 db.
- Notice what is happening here: the volume signal from one track (the vocal) is triggering the compressor on the instruments folder.
- Save the file.

Shown are possible compressor settings that might be appropriate in this case. The trick is not to make the compression too obvious, but to have it just squeezing the peaks of instrument mix down a little to make room for the vocal.

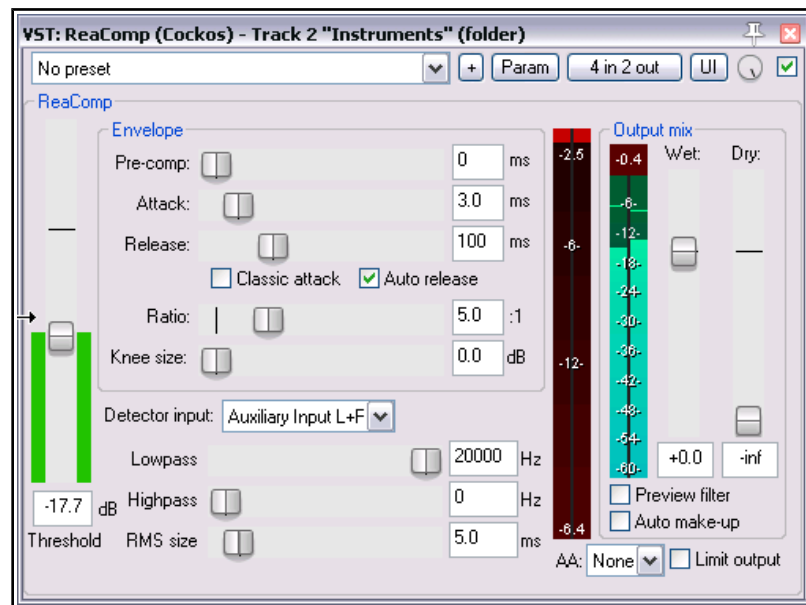
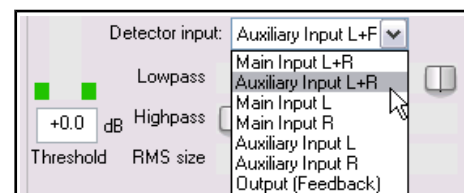
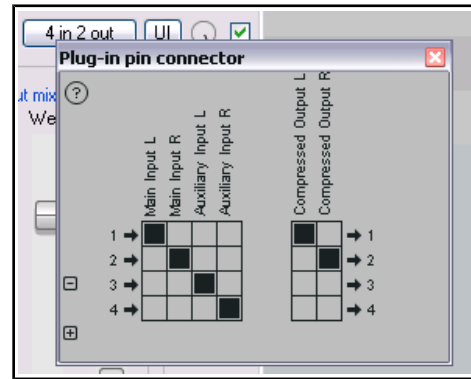

Tip: A quick way to create a sidechain from one track to another is to drag and drop from that track's ROUTING button directly to the window of the plug-in on the receiving track.

17.7 Double Ducking

This example should only be attempted *after* you have completed the example in the previous section **Audio Ducking**. It builds on the work you did there, to apply a further instance of sidechaining, this time to the Master. We will set up another instance of ReaComp, this time in the Master Track, to ensure that another layer of gentle compression is applied to the entire mix during the vocal passages. The same audio stream is used to apply ducking in two different ways – hence the term *double ducking*. As with many of the other examples

17 - More REAPER Routing Examples

included in this section, the main purpose of this example is to help you to understand how to use REAPER's routing capabilities. The example itself is of secondary importance.

In the previous example, we made a send from the Vox track to Channels 3 and 4 on the Instrument Mix track and then used these as Auxiliary Inputs to gently compress the Instrument Mix. Because the Instrument Mix is itself being routed to the Master, that Vox track send will automatically also be sent to the Master on Channels 3 and 4. We can use this to smooth out the mix a little.

Example

1. Open the file **All Through The Night DUCK.rpp** and save it as **All Through The Night DOUBLE DUCK.RPP**.
2. In either the TCP or the MCP, select the **Master** Track. Right-click on the **Volume** fader for the Master and ensure that the number of Channels is set to four (above right). Close this box.
3. Display the **FX Window** for the Master Track and insert **ReaComp**.
4. Open the pin connector window. As before, select **Vox** as the Sidechain receive from channel.
5. Set the **Ratio** to around 2.0 to 1.
6. Display the **Detector Input** drop down list and select **Auxiliary Input L + R**.
7. Play the song.
8. During the vocal passages, adjust the left hand vertical Threshold fader so that the compression kicks in gently. Raise the vertical **Wet** fader by about a decibel or two.
9. Make sure that **Limit Output** is selected. An example of how your settings might look is shown here.
10. That's it! You can now save your file.

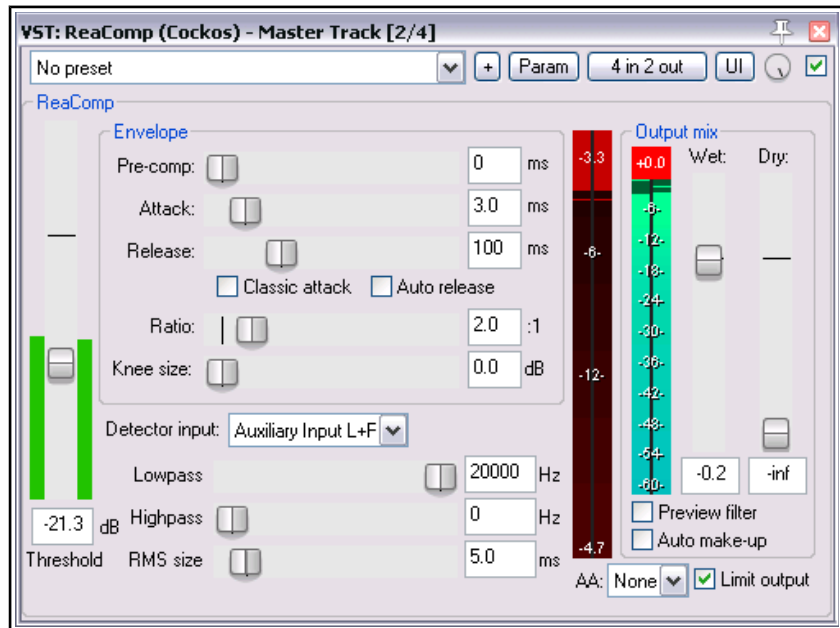

These last two examples have shown how you can use sidechaining for ducking. You can use sidechaining in conjunction with a number of other REAPER plug-ins, including ReaGate, ReaXComp, ReaComp and ReaFir.

17.8 Drag and Drop Routing

The above example uses drag and drop routing. i.e. creating a send by dragging and dropping from the Route button on the source track to the destination track. Let's take a closer look at the drag and drop routing window and its controls.

The two sliders can be used to adjust the send **volume** and **pan** settings, controlling how the output will behave on the destination track. There are **mute**, **phase invert**, and **mono/stereo** buttons, as well as a drop down to select send type (post-fader, pre-fader or post-fx).

You can use the **MIDI** button to send MIDI data rather than audio: in this case you will be able to specify other MIDI settings, such as source and destination channels.

The final button can be used to select a preferred **automation mode** (see chapter 18).

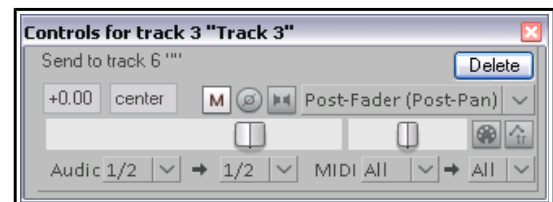

17.9 Using VCA for Track Volume Control

In Chapter 5 we examined REAPER's VCA grouping capabilities in some details. In addition, there are available JS VCA plug-ins that enable you to use one track to control the volume of any other track or selection of tracks. The JS Utility VCA plug-ins allow you to do this, if you wish, without the need for creating groups or folders. They enable you to control the volume of any selection of tracks. They are easy to use and give you great flexibility. Two plug-ins are required – one for a controlling master track, one for each of the slave tracks it controls. You can use REAPER's native JS: Utility VCA plug-ins, or you might prefer Witt's more fully featured variations of these. You can download these at stash.reaper.fm/v/17673/plugins.zip

In this example we will use REAPER's native JS plug-ins. The procedure is as follows:

Example

1. Open the file **All Through The Night** and save it as **All Through The Night JSVCA**. Add an empty track to your project. Name this track something like **VCA Master**.
2. Add the plug-in **JS:Utility/vca_master** to the FX chain for this track. As you can see (right), this has only one parameter, **Volume**.
3. Add the plug-in **JS:Utility/vca_slave** to the first of the tracks whose volume you wish to control, I.e The Gtr Neck track.. This too has a simple interface. This plug-in should be the last in the track's FX chain.
4. You now need to create a send from the Vol Control track to this slave track. The easiest way to do this is simply drag and drop from the **ROUTE** button on the Vol Control track to the slave track's track panel. This causes a send control window (shown right) to appear. Make sure that you select the receiving slave track's sidechain channels (shown here, 3/4) as the destination of the send.
5. Repeat steps 3 and 4 for the Gtr Body track. This track will now be under the control of the vca_master plug-in on the VCA Master track.
6. That's it! You can now use the Volume (dB) fader on the vca_master plug-in to control the volume of all slave tracks. A handy tip is to add a parameter control to the track panel. To do this, within the plug-in window click first on the **Param** button, then on **Show in track controls**. This will allow you to adjust the parameter's level without the FX window needing to be open (see right). Another option is to add an automation envelope for this control.
7. To also display the track parameter control in the mixer panel, simply enable **Show FX parameters when size permits** from the Mixer's context menu. For more information about this, see Chapter 11.
8. Note also that the VCA master's Volume (dB) control can be assigned an automation envelope if you wish. For more information about automation envelopes see Chapter 18.

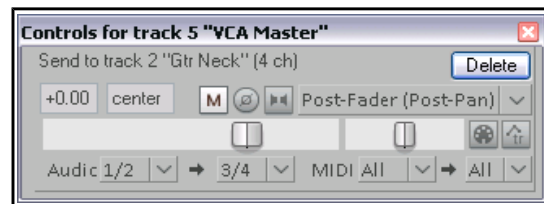
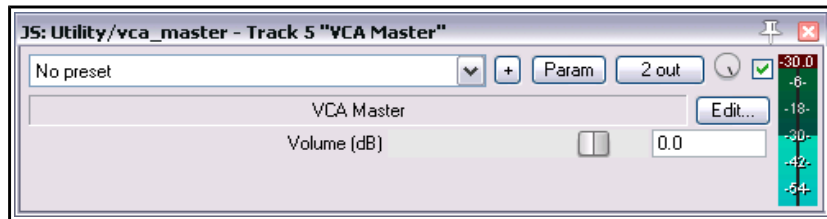

Note: The Witt VCA plugins

The Witt VCA controls plugins are similar to REAPER's native JS versions, the main difference being the addition of drop down lists to enable you to easily select which paired channels are to be used for the sends and receives. By using different permutations of send and receive channels, you are able to set up multiple instances of the VCA master control plug-in. These can be used independently of each other to control the volume on different track selections.

17.10 Multi Output VSTi Plug-ins

You may well use these functions to set up multi output VSTis only once or twice but it's well worth taking the time and trouble. This will give you a much better understanding of the inner workings of REAPER compared with downloading a track template.

Example 1: Paired Audio Tracks

1. Right click over the empty area of the Track Control Panel and from the menu choose **Insert virtual instrument on new track...**
2. When the FX browser window is shown, double-click on the required instrument. This example uses the 8-output version of **Grizzly** (4 stereo channels). You could use any multi output instrument that you wish.
3. You will be asked to confirm whether you want the appropriate number of tracks built for the particular instrument that you have chosen (see right).
4. Click on **Yes**.

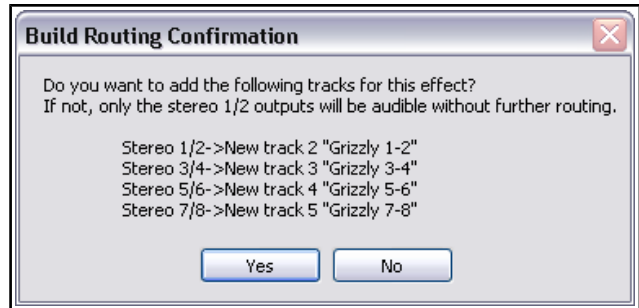

5. REAPER will now insert the instrument into the FX chain for the original track, name it and arm it for recording. It will also create all the additional tracks for you.
6. You now have a single MIDI input track for the VSTi together with

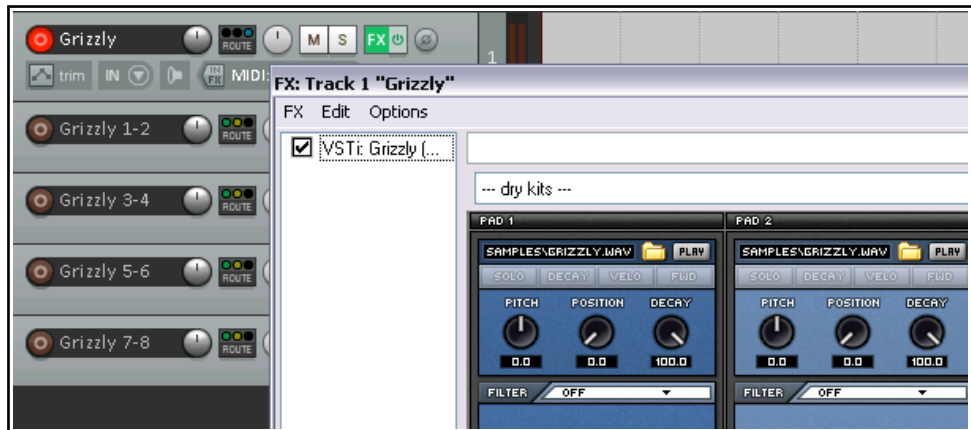

four output audio tracks. Notice that in this example:

- Channels 1/2 from Track 1 are directed to Track 2, Channels 3/4 to Track 3, Channels 5/6 to Track 4 and Channels 7/8 to Track 5.
 - No output is sent directly from Track 1 to the Master.
3. You're now ready to load your instruments (in this example, select a drum kit) and to start playing.

Example 2: Separate MIDI Tracks

If you want a separate MIDI track for each VSTi output channel, you should use this method. Again, for the sake of the exercise, we'll use Grizzly, but you would use the same method for any other multi-output synth.

1. Create a new track and name it. Open the track's FX window and add the required VSTi to the track's FX chain.
2. From the FX window **Options** menu choose **Build 16 channels of MIDI routing to this track**.
3. You now have a separate MIDI track for each channel. The MIDI output of each of these 16 tracks is sent to the track on which you originally inserted the VSTi.



You have a number of options for assisting you with managing this set of tracks. For example, you can put the MIDI Tracks in one folder, name the folder, color the tracks and hide them in the Mixer. To enable keyboard input for the individual MIDI tracks:

- Make sure that the VSTi track is *not* armed for recording.
- Select all 16 MIDI tracks.
- Right-click the Record Arm button and turn Input Monitoring button on for all 16 tracks.
- For each track, set the MIDI input channel, from 1 to 16.

17.11 Using Parent Channels

Parent channels specify the set of channels on a child track to which channels are routed on its parent track. For example, in an eight channel folder track containing two child tracks of four channels each, you could route the output of one of the child tracks to channels 1-4 of the folder and the other to channels 5-8 of the folder if you wished. This would give you audio on all eight channels of the parent.

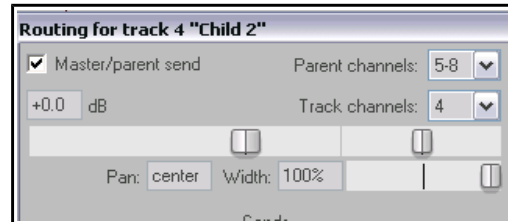

17.12 Parallel FX Processing with the Channel Mixers

Parallel FX processing consists of splitting a signal into separate chains and applying different effects separately to these chains, rather than one after another in a single chain. Earlier in this chapter this technique was used with the full fat vocals exercise. This section takes this idea further, both by allowing more channels and by allowing the pan setting as well as volume level for each channel to be controlled individually.

You'll be using the **IX / Mixer 8xM-1xS** which open up more possibilities for you to split and route your audio thru different channels, then mix them back at the end to produce some truly creative sounds and effects. The main difference between this mixer and the one that you used earlier is that this one works with individual mono channels. The example that follows is designed to show you how this mixer can be set up and used. After working thru it, you should be capable of using it for your own projects.

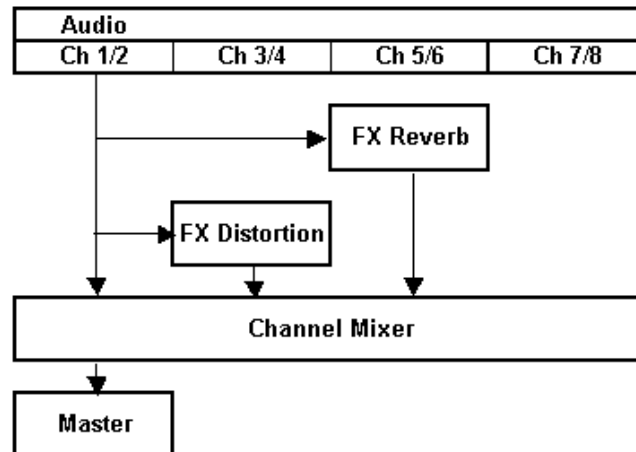

Example

In this example, we will send output from one instrumental track separately to a Distortion FX and a Reverb FX, then mix the wet and dry signals back together, panning as required – all within one single track and without using any busses.

To do this, we'll use the **IX Mixer 8xM** together with a couple of other plug-ins supplied with REAPER. The diagram above illustrates conceptually what we are going to achieve:

We will be running the signal *in parallel* to the two FX. By doing this, we ensure that each effect is processed separately before being mixed. This is different from the normal FX chain, which processes effects sequentially.

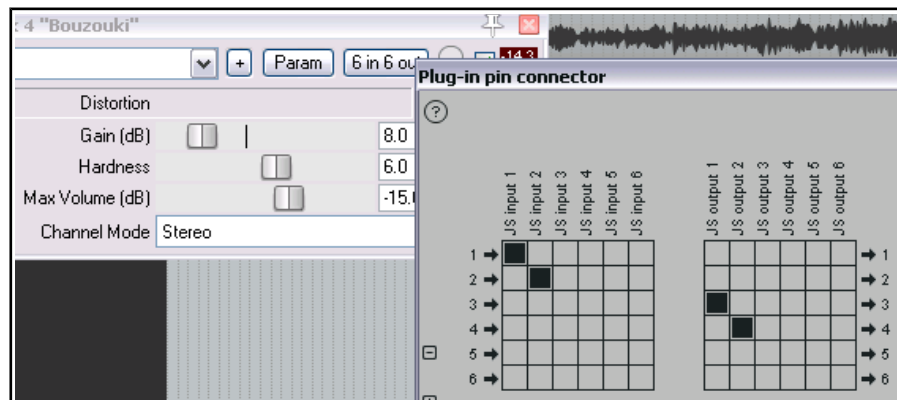

17 - More REAPER Routing Examples

1. Open the file **All Through The Night.RPP** and save it as **All Through The Night IX MIX.rpp**
2. We are going to work on only the **Bouzouki** track. Solo this track.
3. Open the routing window for the **Bouzouki** track. Set the track channels to **6** then close this window.
4. Open the FX window for this track. If any FX are already there, remove them.
5. Insert the FX **JS: Guitar Distortion**. To start with, make the various control settings similar to that shown here (but see note below!).

Note: In this case, at step 5 (above) you should adjust the parameter controls for the plug-in before you open and use the pin connector. This is because you will not be able to hear or monitor any output sent to channels 3 and 4 until later, when you add the channel mixer to the FX chain.

6. Make sure that input is from Channels 1 and 2 only and output is to Channels 3 and 4 only, (see above).
7. Now add **ReaVerbate** to the FX Chain for the Bouzouki.

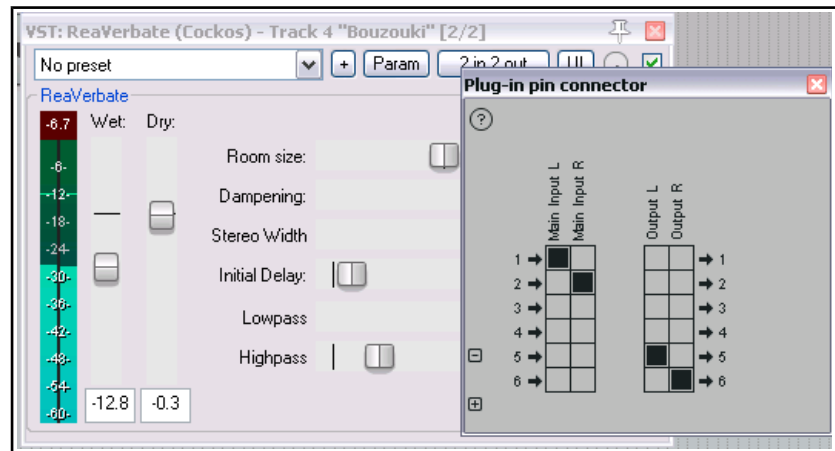

8. Select a preset, adjust wet/dry levels as you wish, then set the Output to Channels 5/6 (see right).
9. Now insert the **JS: IX/Mixer_8xM-1xS** at the end of the Bouzouki track's FX chain.

10. Play the song and experiment with the volume levels and pan settings for your different channels. Experiment with changes also to the FX settings. One suggested possible outcome is shown below.

11. Unsolo the Bouzouki track. Lower the track fader to blend it back into the mix. Save the file when finished.

This is only a simple example. You could in effect have up to four separate FX chains running in parallel within this track. And it's very easy then to move an FX from one chain to another, just by changing its output channels.

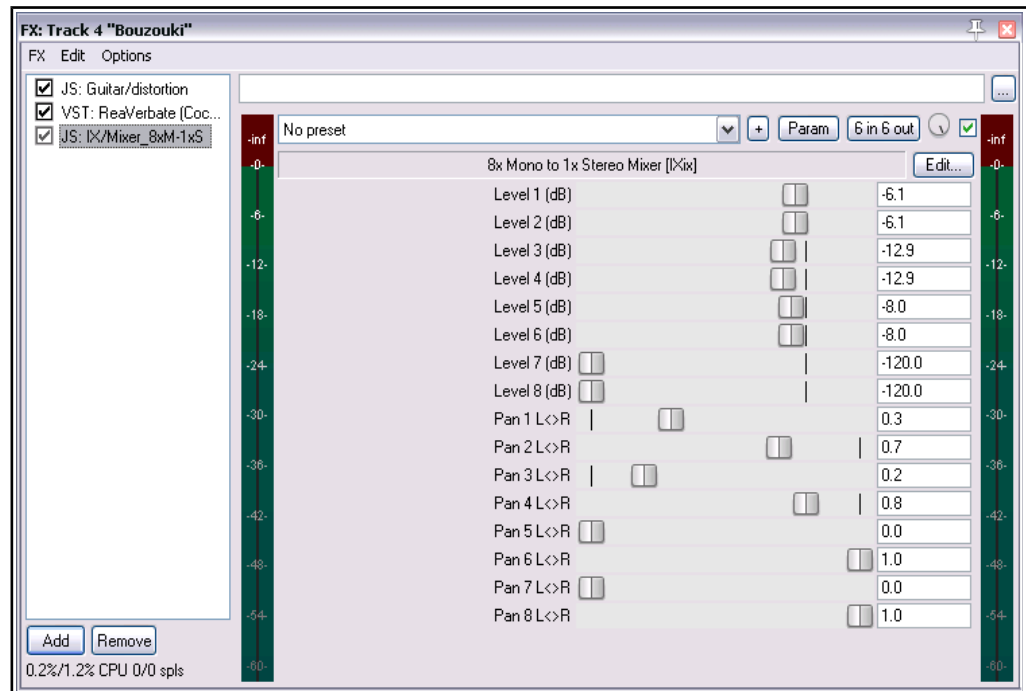

The **IX** series of Jesusonic plug-ins have been developed by Philip S. Considine. A big thank you to Philip for his help in developing this example.

17.13 More Parallel FX Processing

The example you have just considered demonstrates Parallel FX processing at its simplest. By experimenting with this feature you can contour your sounds exactly as you wish. You could for example, add more plug-ins to your chains, and/or use more than 6 channels. All three streams then get mixed back together using the Channel Mixer Plug-in. Example:

- Channels 1 and 2: Dry – the original signal, unprocessed.
- Channels 3 and 4: Distortion then Compression.
- Channels 5 and 6: EQ then Reverb.

17.14 Channel Splitting and Parallel Processing with Item Take FX

The examples used in this chapter have all involved working with plug-ins within track FX chains. Don't forget, however, that any individual media item or take can also contain its own FX chain, specifically assigned to that item or take. Item take FX are explained fully in Chapter 6: in brief, however, you can select any media item and press **Shift E** to create an FX chain for that item. Provided the track that contains the media item has been assigned the necessary number of channels, channel splitting and parallel processing of FX can be applied to individual media items in exactly the same way as explained throughout this chapter.

17.15 Other Channel Routing Plug-ins (Overview)

The list of Jesusonic and Cockos plug-ins for REAPER is an impressive one, and one that is still steadily growing. The following table provides an overview of some of the other channel routing plug-ins that are currently available. You should always check the web sites and the forums for the latest information. This section introduces you to some other plug-ins (not used in these examples) that are specifically designed for use in a multi-channel routing environment.

The information below comes from text files supplied with these plug-ins by their author, Philip S. Considine. Obviously, these plug-ins should only be used on tracks which have more than one defined pair of channels.

Plug-in	Description
IX Switcher	This is a channel switching utility. The Output Source parameter is used to select which one of up to four paired inputs channel is to be monitored. Useful for A/B comparisons.
IX Switcher 2	This is a variation of the Switcher switching utility. The Output Source parameter is used to select which one of up to four paired inputs channel is to be monitored, and the Level faders allow you to adjust the gain independently for each pair. Useful for A/B comparisons.
IX SwitchMitch	This crossfade utility allows you to feed up to four input pairs to two busses then mix those busses to output channels 1+2. The destination for each of the four paired inputs can be set to Off, A, B, or A+B.
IX PhaseAdjustingRouter	Takes the signal from an input channel pair and modifies the phase according to the selected mode. The modified signal is then output on the selected output channels. Only the selected output channels will be modified so, for example, a signal received from inputs 1+2 and output on 3+4 will still be present in its original form at outputs 1+2. The Input parameter selects which paired channels are used for input. The Phase Mode can be set to No Change, Invert Left Channel Only, Invert Right Channel Only or Invert Both Channels. The output parameter selects the output channels.

17.16 REAPER's Routing Interface

If you are using multiple track channels, sends and receives (as do many of the examples in this section), then you should consider keeping the Routing Matrix in view. You can use your routing matrix to make adjustments to any of your sends and receives, or to specify the number of channels required for any track. Some examples are summarised below.

Right click over any track name (as shown above right) to display the Track's Routing Window and change the number of Track Channels, or to adjust the parameters of any Send or Receive associated with that track.

Right click over the Send/Receive signal at any intersection on the Routing Matrix to adjust any of the parameters for that Send or Receive (as shown below right).

Click over any vacant intersection on the Routing Matrix to create a Send/Receive at that point.

Remember, of course, that you can also create, remove and manage sends and receives in the TCP and the MCP. In either case, you can click on any track's **ROUTING** button to display that track's Routing Window, or right-click over the **ROUTING** button and use the fly out menu to easily add a Send or Receive.

Tip: Sends can be copied in the Routing Matrix from one track to another. For example, if you have created a send from (say) track 1 to (say) an effects bus on (say) track 6, then you can create similar sends from other tracks simply by dragging and dropping that send up and down the matrix column.

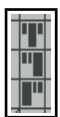
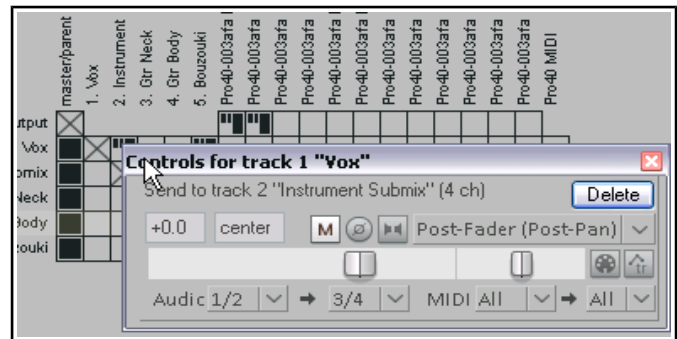
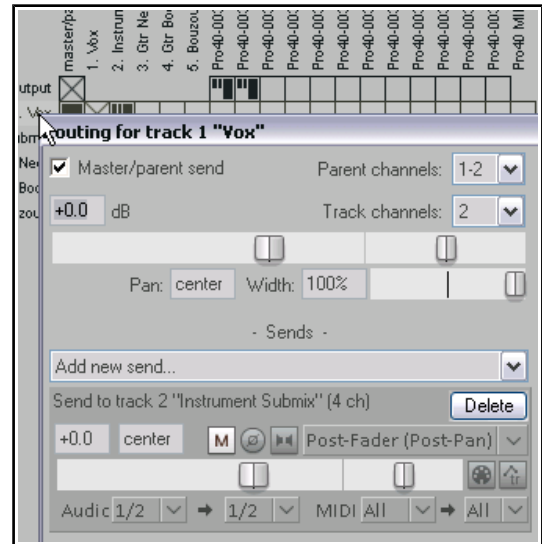

Notice also that the three different types of send are represented in the Routing Matrix by three different symbols, as shown left. As shown, from top to bottom these are **Pre Fader (Post FX)**, **Post Fader (Post Pan)**, and **Pre FX**. In each case, the height of the large thick bar indicates the send volume level. The flow charts in Chapter 6 will help you to understand the differences between these.

17.17 ReaSamplomatic and ReaDrums

This example uses the **ReaSamplomatic** plug-in provided with REAPER in conjunction with the **ReaDrums** track template created by **jamester**. You can download this template from the REAPER Stash on the REAPER web site. To check the current address for this, visit the REAPER Forum and check jamester's signature, or do a search. After downloading, it should be copied into your Track Templates folder. For XP users, this is **C:\Documents and Settings\User Name\Application Data\REAPER\TrackTemplates**

The template does get modified from time to time, so that the version that you download might not be exactly the same as the one used in the description that follows. This should not matter. Also, in the example, we will be using the **MIDI Editor** for demonstration purposes, but if you have a keyboard, you can use that instead.

Example

1. Create a new empty project file and save it as **ReaDrums Example.RPP**
2. Right click over the Track Panel Area and from the menu choose **Insert track from template** then your **ReaDrums** template. Notice that a track will be inserted, with eight individual named instances of **ReaSamplomatic5000** inserted in its FX chain.
3. Notice that each instance of **ReaSamplomatic5000** is set up differently. From top to bottom, these are *Kick, Snare, Perc 1, Perc 2, Perc 3, Perc 4, HH Cl, HH Op*. Near the bottom left corner you can select a MIDI

channel for each sample. The default is 0, which means all channels. Shown here is the Snare, which has been set to use channel 1. In this illustration, an audio sample has also been inserted. That's the next step!

4. Display the Media Explorer – **Ctrl Alt X** – and select a folder where your samples are stored.
5. In the ReaDrums FX window select the item Kick. From REAPER's media explorer window you can drag with your mouse the required sample file and drop it into the ReaSamp window, in the black area above the Browse button.

Alternatively, you can either use the plug-in's **Browse** button to make your selection, or select any existing item in Arrange view and click on **Import item from arrange**. Another option is to click on the **[list]** button to open a window to build up a list of samples. This can be sorted by file name, or by peak or RMS values.

6. Now repeat this process in the other seven ReaSamp instances, one at a time, for each of the other seven instruments, each time inserting a different appropriate sample. If you wish, rename any of the ReaSamp- Omatic5000 instances to reflect the sample name.

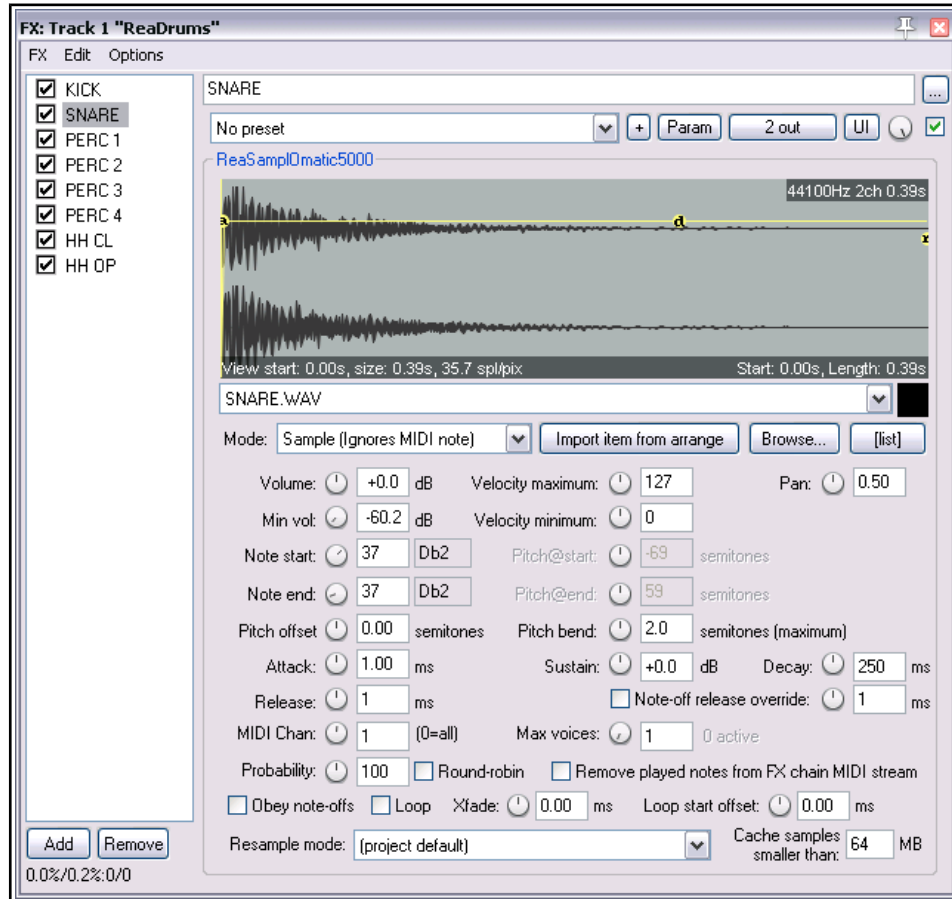

7. Notice that each instance of ReaSampOmatic5000 uses different **Note start** and **Note end** settings. This makes allows the notes (and any other events) for the different instruments to share a single MIDI item.
8. Make sure the ReaDrums track is not record armed. Save the file.
9. Along the timeline select the first 10 seconds or so. With your ReaDrums track selected, choose the **Insert, New MIDI Item** command to insert a MIDI item.
10. Double click on this item to open the MIDI Editor. From the menu choose **View, Piano Roll Notes, Triangle** and **View, Mode, Named notes**. If necessary, scroll up or down to display your samples. For each sample, its row number will correspond to its ReaSampOmatic5000 note start/end setting. For example, in this case the snare (shown above) will be row 37.
11. Compose a few notes, similar to the concept shown below. Don't copy this pattern, make a simple composition of your own.
11. Close the MIDI Editor and save your file.
12. If you wish, you can also use REAPER's channel routing to send different parts to different tracks, where you can add FX, adjust panning, volume, etc. Let's suppose we wish to apply some FX to the kick and the snare individually. Right click over the Volume fader for the ReaDrums track and set the number of channels to four. We'll start with just one or two.

13. Press **Ctrl T** twice to add two more tracks. Name the first of these tracks **Kick**, the second **Snare**.

14. In the **ReaDrums** track set the number of Channels to 4, and create a send to the new **Kick Track** (using channel 3) and the **Snare Track** (using channel 4).

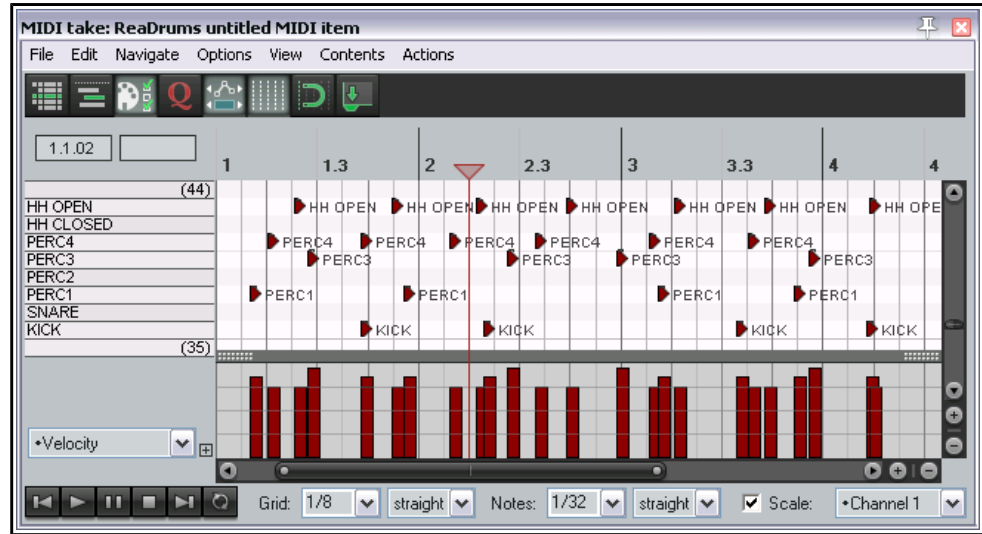

15. Open the **FX Window** for the **ReaDrums** track.
16. Select the first **ReaSamploMatic5000** instance, the **Kick**. Set both of its VST Outs to Channel 3.
17. Select the **Snare ReaSamploMatic5000** instance and set both of its VST Outputs to Channel 4.
18. Now play the music. Notice that the Kick and the Snare have been rerouted to their respective tracks. You could now place any FX that you wish in the FX windows for those tracks. Save the file.
19. If you add more channels to the original ReaDrums track, you can now repeat this effect for any other of your Drum parts.

Tip: If you download the track template **ReaDrums Rack** from the REAPER forum, you will find that in this template all the individual tracks, along with their routing, have already been set up for you.

ReaSamploMatic5000 is a very powerful and flexible piece of software. Its many capabilities and applications extend well beyond the simple example outlined above, and beyond the scope of this User Guide. They could well command an entire manual in their own right! For example:

- ◆ Each instance of ReaSamploMatic5000 has its own independent set of controls (volume, pan, pitch bend, attack, sustain, release, decay, etc).
- ◆ Changes made to the attack, delay, sustain and or release settings will be represented on the graph (envelope) that is superimposed on the sample waveform in the ReaSamploMatic5000 window.
- ◆ The **Max Voices** rotary can be used to select any number between 1 and 16. However, if you need more than 16 you can type in any number up to 128. This, for example, allows ReaSamploMatic5000 to be used with long cymbal rides. Notice too that the number of active voices is shown during playback next to the max voices value.
- ◆ For most of the controls you can create arrange view automation envelopes and/or control them using parameter modulation. These topics are explained in Chapters 16 and 17.

ReaSamploMatic5000 can be challenging for inexperienced users and requires a sound general understanding of MIDI and sampling concepts. Another example follows below. For more information about the various ReaSamploMatic5000 parameters and controls, see the free REAPER Effects Guide, available at <http://www.cockos.com/~glazfolk/ReaEffectsGuide.pdf>

17.18 Round-Robin Multisampling

The round-robin option can be used in conjunction with the probability setting to determine whether any given instance will produce a sound from any given note. For example, at 100% it will play every note. At 50% it will ignore every other note. This can be used to introduce variation into your sampled sounds. Consider an example where you use a separate track for each percussion instrument – kick, snare, etc.

Up and Running: A REAPER User Guide v 5.24

Shown here is a simple arrangement for the snare track, with two instances of ReaSampleOmatic5000, each containing a separate and subtly different snare sample.

For both instances **round-robin** and **Remove played notes from FX chain MIDI stream** have been enabled. For Snare 1 probability is set to 50%, for Snare2 100%. This ensures that during playback each of the two instances (and therefore two samples) will be used alternately, in rotation. If in this example you had three samples rather than two, probabilities would be set at 33% (1 in 3), 50% (1 in 2) and 100% (1 in 1) respectively. Four four samples, these settings would be 25% (1 in 4), 33% (1 in 3), 50% (1 in 2) and 100% (1 in 1), and so on.

More complex variations are possible. For example, a JS: MIDI/midi_choke plug-in is available which can be used in conjunction with

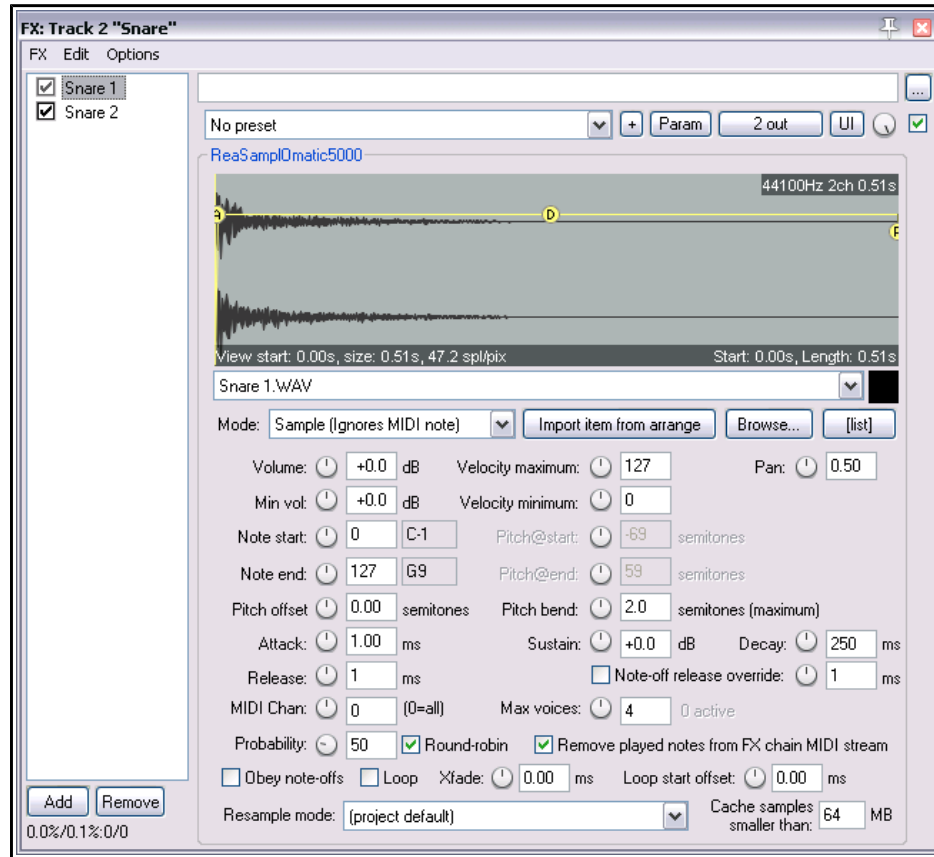

ReaSampleOmatic5000 to help control whether any sound will be produced from a given note. An example showing how this can be used can be seen here: <http://forum.cockos.com/showpost.php?p=1278385&postcount=28>

The chart on the right (courtesy of Tod) shows the various probabilities when different numbers of samples are used.

The option **Remove played notes from FX chain** should in each case be enabled on all but the last RR.

Make sure Remove played notes from FX chain is checked on all but the last RR.

# RRs	1	2	3	4	5	6	7	8	9	10	11	12	13	14	15	16
1	100	50	33	25	20	17	14	13	11	10	9	8	8	7	7	6
2		100	50	33	25	20	17	14	13	11	10	9	8	8	7	7
3			100	50	33	25	20	17	14	13	11	10	9	8	8	7
4				100	50	33	25	20	17	14	13	11	10	9	8	8
5					100	50	33	25	20	17	14	13	11	10	9	8
6						100	50	33	25	20	17	14	13	11	10	9
7							100	50	33	25	20	17	14	13	11	10
8								100	50	33	25	20	17	14	13	11
9									100	50	33	25	20	17	14	13
10										100	50	33	25	20	17	14
11											100	50	33	25	20	17
12												100	50	33	25	20
13													100	50	33	25
14														100	50	33
15															100	50
16																100

Round Robin Probability chart for ReaSampleOmatic5000

17.19 Multichannel Track VU Meters

When a track consists of more than 2 channels, you can choose whether to have all channels or only channels 1 and 2 displayed in the track's VU meter (track panel and mixer panel). Select (in TCP or MCP) the track or tracks required, then then from REAPER's main menu choose the **Track** then **Multichannel Track Metering**. This is a toggle command: to remove multichannel metering from a track, simply select the track and give this command again.

In the example shown here, this option has been disabled for the first of the tracks shown and enabled for the second.



17.20 Surround Panning with ReaSurround

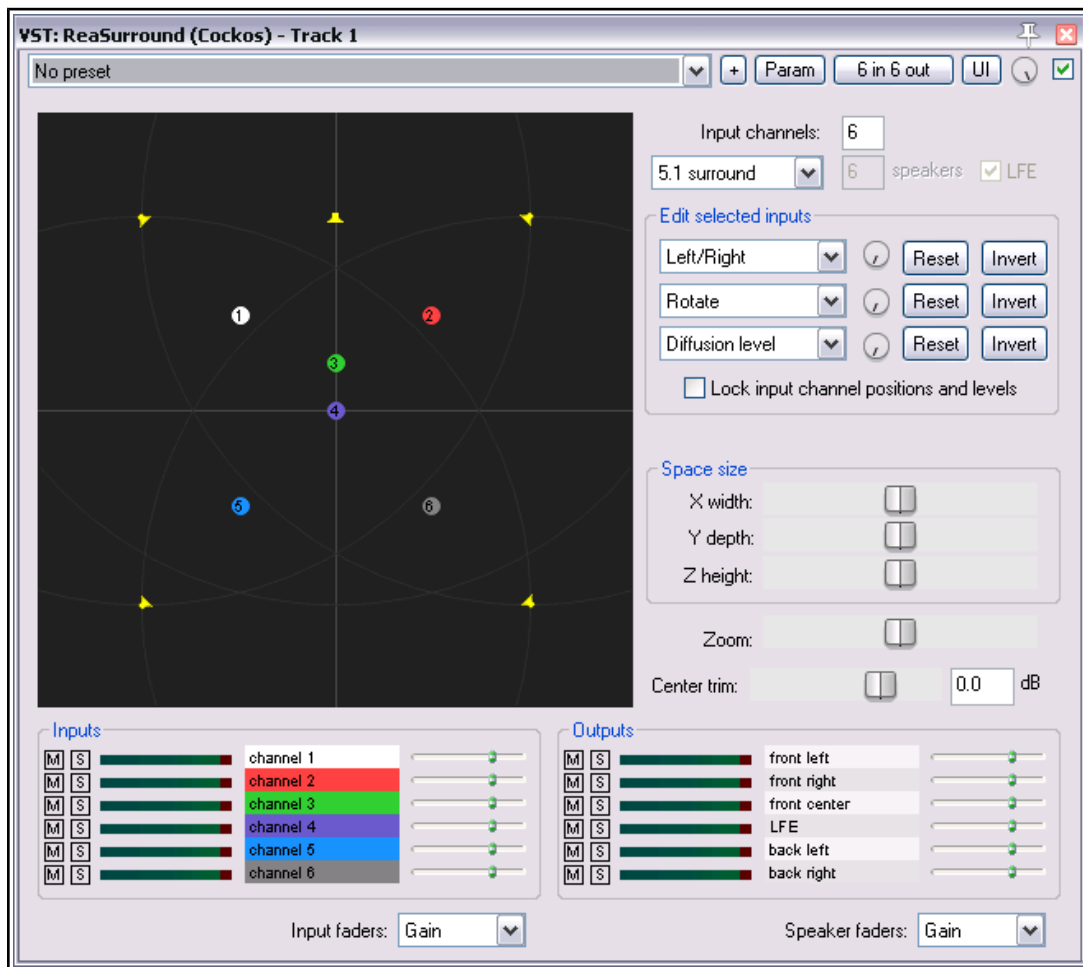

Surround sound production is a complex topic. It would be beyond the scope of this User Guide to attempt to cover the principles, theory and practical issues that it involves. Whole books have been written on the subject: you can also consult various web resources, such as "The Recording Academy's Producers and Engineers Wing Recommendations for Surround Sound Production" (available as free PDF download).

REAPER's surround sound production capabilities can be found in three main areas:

1. The ability to record in multichannel format. The method for doing this is explained in Chapter 3.

Up and Running: A REAPER User Guide v 5.24

2. REAPER's channel routing capabilities.
3. The ReaSurround surround panner.

Thus, the REAPER-specific issues that you need to be aware of for surround sound production are:

Recording

Record each track using the settings most suitable for that track. For example, for a lead vocal you might use a two channel track with a single mono input (one mic). For a piano, you might record in stereo with two mics. For ambient sounds you might prefer a four channel track with four mic inputs.

Routing

REAPER offers you various routing options. For example, you can insert ReaSurround into each track individually, with each track directly routed to the Master. Another option is to create sends from all tracks to a single Surround Mixing Bus and use a single instance of ReaSurround there, disabling direct sends from individual tracks to the Master. The former method gives you greater flexibility and more control.

You will also need to set up the necessary routing for your Master outputs to ensure the correct signal flow from your Master to your surround speakers. A possible example of this for 5.1 surround sound is shown here (right).

ReaSurround

ReaSurround, like any other plug-in, can be inserted into a track's FX chain from the FX Browser. Here we are assuming that you are opting for the method of inserting ReaSurround into every track. Note that:

- ◆ You should place ReaSurround in the track's FX chain. Often you will want this to be at the end of the chain. However, this might not be the case if, for example, you are using a multi-channel delay effect, which most likely you will want to be after ReaSurround.
- ◆ After inserting ReaSurround, select one of the options from the setup drop down list (above left). Select the same option for all tracks. Input levels and positions can be set and locked.
- ◆ When you select a setup, the correct number of output channels are automatically added to the track. In the example here, 5.1 surround is selected, so the track is allocated six channels.
- ◆ In the example shown below (next page), a track with two channels and a mono media item (Vox Mix) displays two channel inputs, each with its own fader(which can be set to Gain or LFE) as well as solo and mute controls. Double-click on any input to rename it.
- ◆ Because 5.1 surround has been selected, there are six channel outputs. Notice that these can be soloed and/or muted in any combination. Each also has its own fader: these can be set to Gain or Influence.
- ◆ Use the pin connectors on other track FX to direct the outputs of those FX to the various channels, as required. Refer back thru this chapter for numerous examples of selecting FX pin connectors.
- ◆ You should also insert ReaSurround at the end of the Master FX chain.

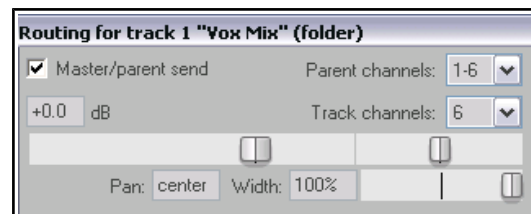
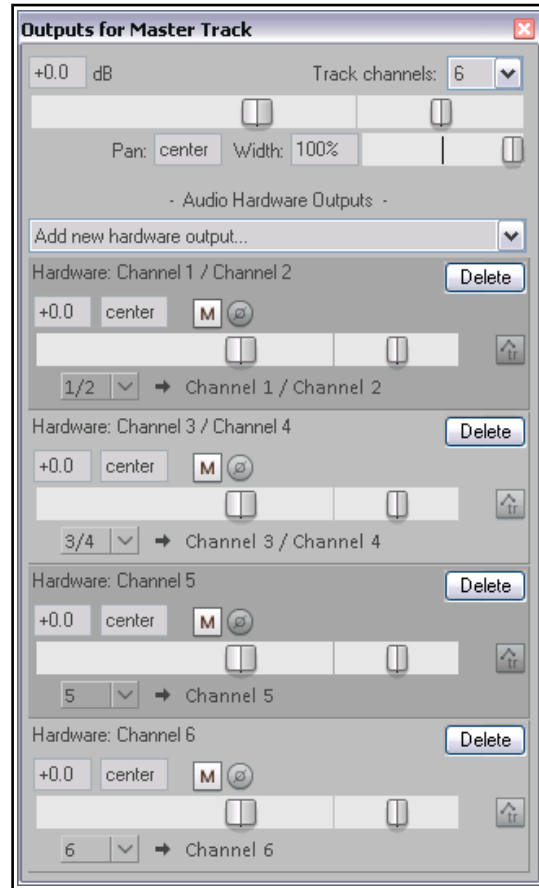
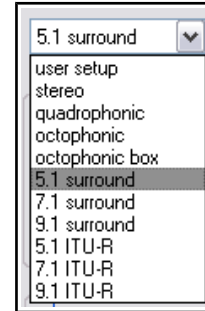

Channel inputs can be positioned by clicking and dragging them across the display. In addition, there are two further sets of controls in the ReaSurround window.

The three **Edit** drop down lists and their accompanying rotaries can be used as controls with any three of the available items shown (right). These include Left/Right, Back/Front, Low/High, Back Left/Front Right, Front Left/ Back Right, Expand/Contract, Rotate, LFE Send, Diffusion Level and Diffusion Bias. There is also an option to **Lock input channel positions and levels**.

The three horizontal **Space size** faders can be used to adjust the three dimensions of the surround environment, width, depth and height, with the fourth fader acting as a zoom control.

The various **Inputs** and **Outputs** controls can be used to mute, solo and or adjust the levels for Gain or Low Frequency Effects (inputs) or Gain or Influence (Outputs).

In the example shown here, the Surround Panner has been inserted into a "normal" two channel track with a mono recorded media item. The Surround Panner therefore finds – and displays – only two inputs this time.

Because 5.1 surround has been selected as the surround mode, the input from the two channels can be directed to the six channels shown.

See also Chapter 21, Rendering in Surround Format.

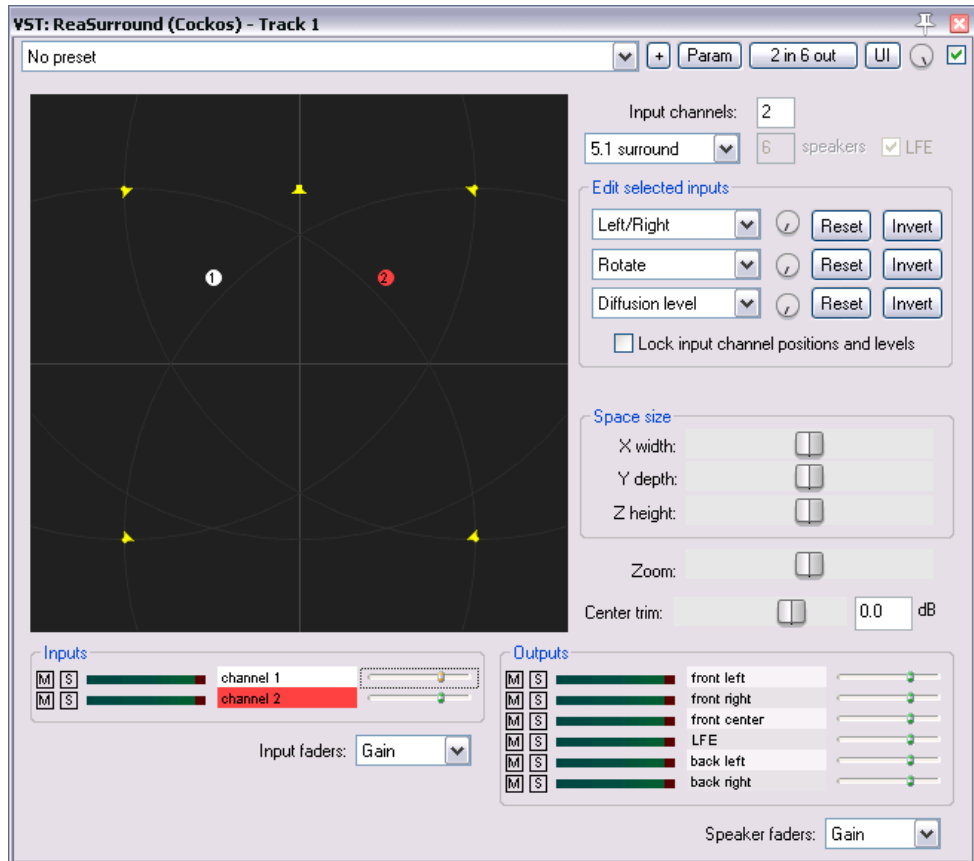
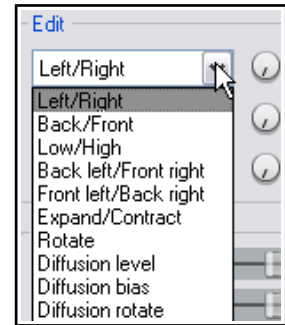

17.21 Routing to/from Other Applications with ReWire

All of the examples that we have looked at up to now have involved routing audio or MIDI data within REAPER. We're now going to take a look at how your music can also be routed to and from other applications.

Users of ReWire will be pleased to know that REAPER supports ReWire (2.6). ReWire is a technology jointly developed by Propellerhead Software and Steinberg to allow applications to share audio, MIDI and synchronization data. Audio and MIDI data are transferred between the two applications in real-time, allowing you to use the features in each application as if they were one.

ReWire functionality is automatically installed along with REAPER on the OS X. Windows users need to make sure when installing REAPER that they have ReWire selected and enabled on the **Choose components** page of REAPER's Install wizard under **Additional functionality**.

Up and Running: A REAPER User Guide v 5.24

In a ReWire session, the first application acts as the host, and the second application acts as the slave. The slave receives and sends signals via the host application. REAPER can be used as either host or slave.

For more comprehensive general information and documentation about ReWire, visit <http://www.propellerheads.se/technologies/rewire/>

The ReWire system uses mixers, panels, and devices. Mixers are the host applications which typically do the sequencing at one end and the final mixdown at the other end. A device is a dynamic link library that only generates sound but has no user interface of its own. A panel is a graphical interface for setting the parameters of one device. For example, you might use REAPER as your mixer and Propellerhead Reason as your synthesizer. In this case Reason would provide device and panel to REAPER, which could then send midi commands, sync timing and mix Reason's output into its own effects chains.

ReWire can be used with any track(s) within a REAPER project. Display the track's FX chain and select ReWire from the list of plug-in categories (left column). This will display (in the right column) a list of all ReWire enabled applications that have been installed on your computer. Select the application ("slave") that you wish to use – for example, this might be ReWire Ableton Live, Rewire Reason or (as in the example shown here) ReWire FLStudio.

In a ReWire session, the first application acts as the host and the second application as the slave. The slave receives and sends signals via the host application.

Selecting your ReWire enabled application will cause the application to be opened. You can use ReWire to send MIDI data to the slave application (as shown in the example above), to route audio from the slave application into REAPER, or to route MIDI data from the slave application into REAPER.

By default, the tempo for both applications is set by the ReWire host. However, there is an option in REAPER's ReWire window to allow the slave application to set the tempo.

Note: REAPER can be opened in slave mode from the Windows Start, All Programs menu, or by first opening the host application and by selecting REAPER as the slave application there. You can also (in both OSX and Windows) ReWire REAPER to itself by choosing Rewire REAPER from the Add FX window.

Further information about using ReWire with REAPER can be found in the REAPER Wiki at '

wiki.cockos.com/wiki/index.php/ReWire

17.22 Introducing ReaRoute

ReaRoute is a feature unique to REAPER that offers you other ways of sharing data (audio and MIDI) in real time with other applications. ReaRoute is covered in detail in its own chapter, Chapter 24.

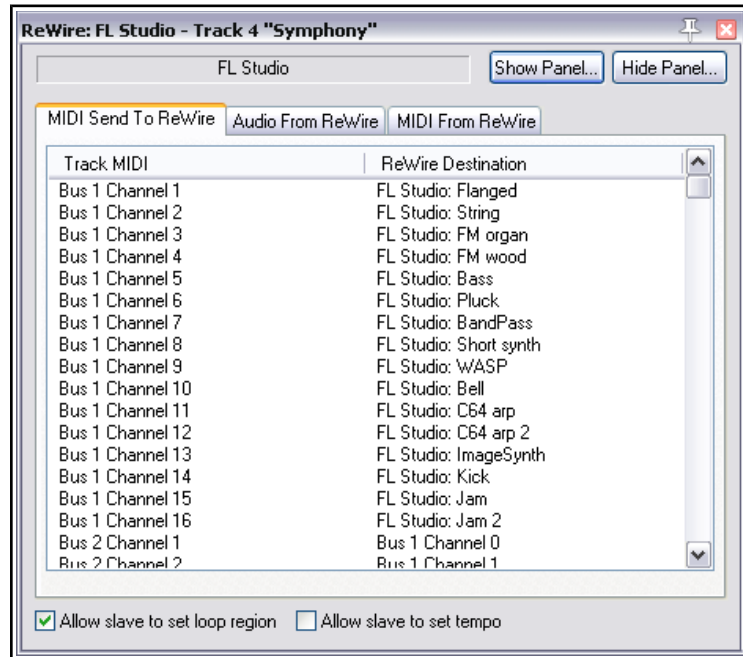

18 Automation with Envelopes

18.1 Understanding Automation

Automation is used to ensure that when your tracks are played, recorded changes in such things as volume level or panning can be recalled with the music in real time. At its simplest, for example, automation can lift the volume of a lead instrument during a particular break or passage, or add a little presence or warmth to the odd phrase here or there on a vocal track, to make it stand out in the mix a touch more.

An example of a simple envelope (for Volume) is shown here. The envelope is in this case displayed below the media item. In the TCP you can see an envelope panel with its own envelope controls, just below the track controls. When the track is played, the volume of the track will rise and fall, following the shape of the envelope.

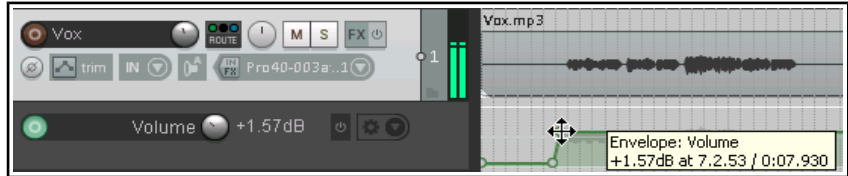

In this second example (below) the same envelope is displayed this time not in its own lane but on top of the media item. Both methods have their advantages and disadvantages. The first makes it easier to work with the envelope, but uses more screen real estate.

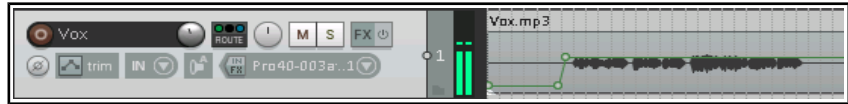

The second takes up less space, but makes tasks such as editing that little bit trickier. Whether your envelopes are initially created in separate lanes or over the media item will depend on your Editing Behavior Envelopes Preference Settings. Keep in mind that you can change the display mode of an existing envelope at any time. REAPER features two main types of automation – one method uses *envelopes* alone, whilst the other uses a rather more complex (and powerful) technique known as *parameter modulation*. This chapter will deal with creating and using envelopes. Parameter modulation will be covered in Chapter 19.

18.2 Automation Envelope Methods

REAPER's various automation modes essentially make available to you two main ways of using envelopes for automating your projects. These are writing automation and manually creating envelopes.

- Writing Automation:** When writing automation, you instruct REAPER to remember your actions – such as fading a volume control up and down – as your project is played. These actions are used to create an envelope which is then reproduced when you play back the track. There are three different methods that you can use to write such envelopes – write, touch and latch (including latch preview). We'll get round to explaining the differences shortly.
- Manually Creating Envelopes:** As an alternative to using your faders to create envelopes, you can shape them manually. This gives you a very fine degree of control over your project. You can draw your envelope curves freehand, add points to them at will, and use your mouse to manually move these points up or down. Envelopes created in this way will behave in exactly the same way as if actual fader movements had been recorded. Trim/Read mode is used when you are creating or editing envelopes in this way. If you wish, you can write envelopes in, say, latch mode then edit them in Trim/Read mode.

Trim/Read (default, faders are active for trim but not recorded) Read (play faders with armed envelopes) Touch (record fader movements to armed envelopes) Latch (record fader movements after first movement) Latch Preview (allow temporary override of armed envelopes but do not write) Write (record fader positions to armed envelopes)
--

Whichever mode is currently selected is displayed on a track's envelope button. We'll explore the different automation modes in detail in the sections that follow. Both have their advantages and you can use any combination of modes on different tracks in your project. With both recorded and manual envelope automation, it is perfectly possible (and quite easy) to edit the automation instructions afterwards, or to remove them altogether if that's what you want to do.

18.3 The Track Envelopes Window

Any track's envelopes can be managed from the **Envelopes Window** for that track. This is opened by clicking on the track's **Envelope** button in either the TCP or MCP. You can use this window, for example to:

- Set the **Automation mode** for the track.

Up and Running: A REAPER User Guide v 5.24

- Create an envelope (e.g. for Volume, Pan or Mute for a track or send).
- To show or hide an envelope from view.
- To Arm an envelope or Disarm it.

This envelopes window includes buttons that can be used for such global options as showing or hiding all envelopes on that track. These issues will be explained and explored in the pages that follow.

The **Highlight** box can be used to help you find what you are looking for more easily. For example, type *volume* in the highlight box and all items whose name includes *volume* will be highlighted.

Any plug-ins that have been placed in the track's FX chain will also be listed in this window. In this example, we have ReaComp. Click on the small **+** symbols next to the plug-in's name to open up a list of plug-in parameters for which you can also create envelopes. We'll see some examples of this soon.

Checking the option to **Show last touched FX parameters only** can help prevent screen clutter.

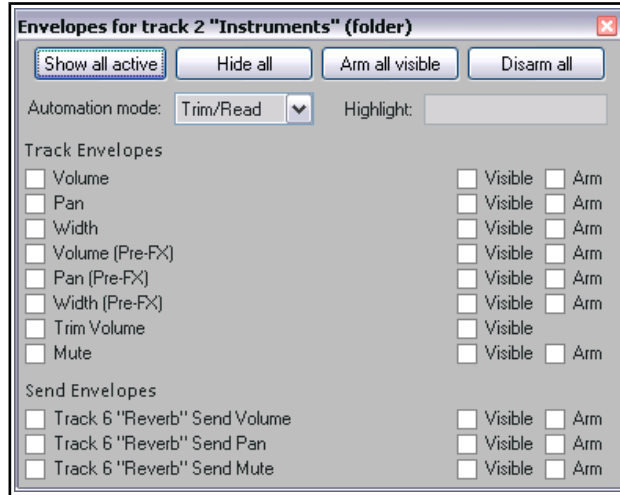

Tip: By default, the shortcut keys **V** and **P** can be used to toggle the display of **Volume** and **Pan** envelopes

18.4 Available Track and Send Envelopes

The following are the automation envelopes that by default are available for all tracks and sends. Envelopes for plug-ins and FX will be discussed later in this chapter.

Envelope	Description
Volume	Adjusts the volume of the Track's Output, after, for example, any item or track FX have been applied. This sets the level of the signal that is sent to the Master Track.
Pan	Moves the balance pan control more towards the left, right, or dead center: the signal that is sent post FX from the track to the Master Track.
Width	Moves the width control more towards the left, right, or dead center: the signal that is sent post FX from the track to the Master Track.
Volume (Pre FX)	Adjusts the volume of the track signal that is fed to the track's FX chain. This is generally equivalent to the Gain control that you can find on some desks and mixers.
Pan (Pre FX)	Similar to Pan control but before track FX or track faders are applied.
Width (Pre FX)	Similar to Width control but before track FX or track faders are applied.
Trim Volume	A rather different type of envelope that can be used to modify the track volume envelope. This will be considered later in this chapter.
Mute	This envelope has effectively only two states – On and Off. It is used to mute passages of a track.
Send Volume	Adjusts the volume of the track signal that is sent to the destination track. Can be used for Post Fader (Post Pan), Post FX and Pre FX sends.
Send Pan	Adjusts the panning of the track signal that is sent to the destination track. Can be used for Post Fader (Post Pan), Post FX and Pre FX sends.
Send Mute	This envelope has effectively only two states – On and Off. It is used to mute passages on a send.

18.5 Writing Automation

To create automation envelopes using the **Write** feature, use this method:

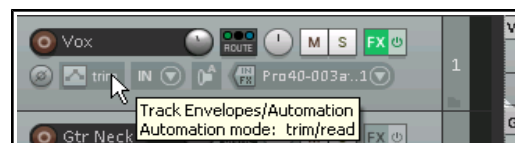

- ◆ In the MCP or TCP, click on the **Envelopes** (Automation) button (right) to open the track's envelopes window. The envelope button displays the currently selected automation mode for that track. In the example shown, this is Trim.
- ◆ Select the item you wish to automate, and make sure to also select the options **Visible** and **Arm**.
- ◆ Set Automation mode to **Write**.
- ◆ Close the Envelopes window.
- ◆ Position the Edit Cursor where you wish to start.
- ◆ Play the song. As you do so, adjust the on screen control which controls the parameter that you are automating. Stop play when finished.
- ◆ Right click over the Envelope button for that track and select **Trim/Read** or **Read**.
- ◆ Play the song. Listen and look! If you selected **Read** mode, the faders will move up and down as the automation is applied.

Note that if you prefer, instead of opening the envelopes window, you can right-click on the track's envelope button and make your choices from the context menu (see right).

Tip: If you enable **Automatically add envelopes when tweaking para in automation write modes** (Options, Preferences, Automation), then when write mode is selected you can create any envelope automatically simply by adjusting the required track or FX parameter control during playback.

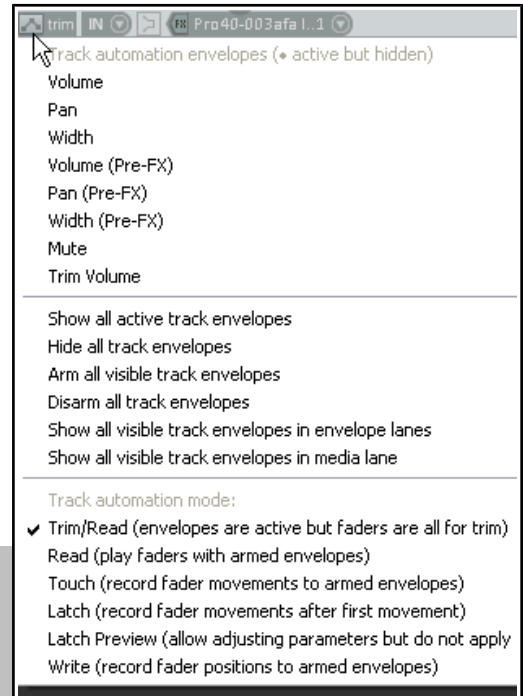

Automation Write Example

1. Open your file **All Through The Night.RPP**. Save it as **All Through The Night AUTO.RPP**. We are going to add an automation envelope to the Bouzouki track to fade this track up a little in the passage between the first and second verses of this song.
2. Use your mouse to increase the height of the **Bouzouki** track. This isn't absolutely necessary, but makes it easier to see what you are doing.

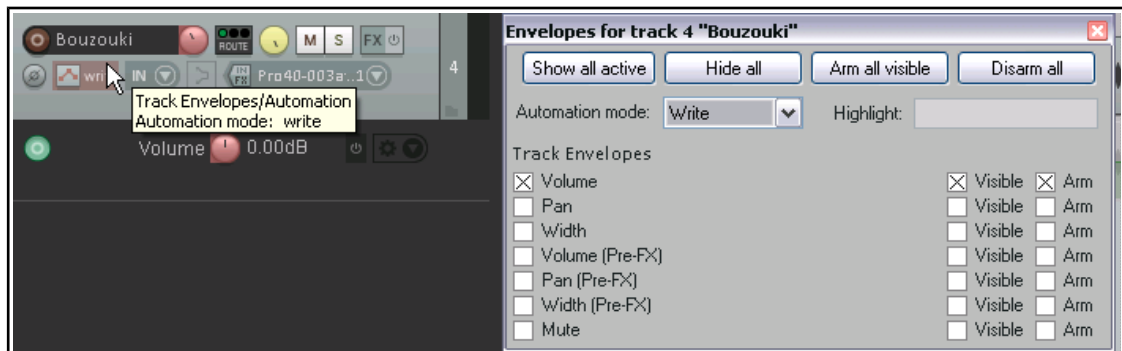

3. Insert the **JS: Utility/Limiter** plug-in to the master track and set its threshold to **-2.0**. This is a precaution against clipping. Position the play cursor just before the end of the first vocal passage at about the 40 second mark.
4. Now click on the **Envelopes/Automation** button for the **Bouzouki** track. Select **Volume** and make it both **Visible** and **Armed**. Select the automation mode **Write** for this track (see above).
5. Close the Envelopes window. Notice that the Volume fader for this track is now colored red and a Volume envelope has been created. The Envelope button now reads **Write**.
6. Play the song from about the 48 sec mark for about 15 sec. At the instrumental break, use your mouse to raise the track fader for the Bouzouki volume (not the envelope volume fader) by about a three decibels. Hold it there, then at the end of the instrumental break lower the fader to its original position. Stop play.

Up and Running: A REAPER User Guide v 5.24

7. Right click over the Envelope button for the Bouzouki track and choose **Automation Mode: Read** from the context menu. Zoom closely into the part of the song that goes from about 45 secs to about 65 secs.
8. The fader area for the Volume control on this track will now be green, and your automation envelope should be clearly visible (see right).
9. Play the song. The volume faders for this track (in both arrange and mixer views) will automatically move to show changes in volume in accordance with the movements that you recorded. Save this file.



Note: You do not need to select Automation Read mode in order for the automation to take effect. Trim/Read mode, for example, will also do this, but without moving the faders. In the above case, this would allow you to tweak the track's volume during playback by manually adjusting its volume fader. You'll find a more detailed explanation of the various automation modes later in this chapter.

Modifying the Envelope

It's very likely that you won't get the exact settings for your automated faders 100% correct first time. To fix this, either use Automation Touch mode to write changes to your envelope, or edit the envelope by hand.

18.6 Envelope Points Options

Right click on the envelope button on the main toolbar for a number of options that will help determine envelope behavior. These are also available on the **Options** menu (**Envelope points** command).

The option to **Move envelope points with media items** should be enabled if you wish an envelope to follow its media item when that item is moved.

Be careful how you use **Envelope point selection follows time selection**. This enables you to move all points within a time selection by clicking and dragging on any one of them. If you want to move only one point (or a selection of points) within a time selection, make sure that this option is disabled.

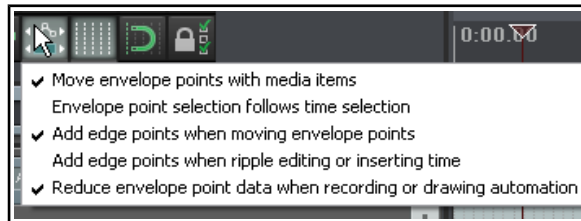

Edge points can be used to make it visually easier for you when you are moving a group of points within a time selection: enable **Add edge points when moving envelope points**, make the time selection, choose **Select all points in time selection**, then click and drag (left or right) any envelope point within the selection.

The option to **Reduce envelope point data when recording or drawing automation** should be enabled if REAPER is creating more points than you want when, for example, you write automation data, using either your mouse or a control surface.

To reduce the number of points on an existing envelope that has already been recorded:

1. Select (click on) the envelope.
2. Define the required time selection. All envelope points in that selection will be selected. You might want to zoom in.
3. Right-click over the envelope.
4. From the menu, choose **Reduce Number of Points**.
5. Select (probably) **Points in time selection only** or (possibly) **All Points**.
6. Adjust the fader until the number of points shown looks about right. An example is shown above.
7. Click on **OK**.

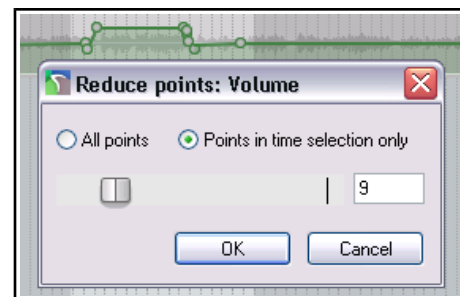

18.7 Writing Mute Automation

One special way of using automation is in conjunction with a track's **Mute** button to automatically mute unwanted passages of a track. The procedure for doing this is outlined below:

- Click on the track's **Envelopes/Automation** button to display the envelopes window.
- Select the **Mute** envelope and set the mode to **Write**. Then close the Envelopes window.
- The Envelopes/Automation button will read **Write** and the armed mute button will be highlighted in red. Notice (above) how this is displayed when set to this mode.
- Now play the track. As you do so, click on the track's Mute button at the start and end of any passages that you require to be muted.
- When finished, stop playback. Automation mode for this track should automatically change to Trim/Read (unless this default setting has been changed in your Editing Behavior, Automation preferences).



In the example (right), a vocal track is muted when it is not intended to be heard. **Read** mode has been selected. When the track is played back, the color of the Mute button changes to red during the muted passages.



18.8 Automation Modes

Automation mode can be set as already shown from inside the Envelopes/Automation window or by right-clicking on the track envelopes/automation button. In fact, there are a number of ways that this can be done:

- Select the required mode from the Envelopes window.
- Right-click on the Envelopes/Automation button and select the required mode from the context menu.
- In the TCP, right click over any automation lane and select the required mode from the context menu.
- From the main menu, choose **Track, Set track automation mode** (or right-click over the track number and select this from the context menu).

The following table summarizes the six available automation modes.

Automation Mode	Description
Trim/Read	Existing envelopes are applied, but on-screen controls do not move. Trim/Read mode might seem strange at first, but it does bring you a useful benefit. You can use a track's controls for overall changes. Fader movements are not recorded. For example, adjusting a track's Volume fader in this mode will raise or lower the volume for the whole track relative to the envelope.
Read	Applies envelopes and moves controls for armed items, but does not write or remember any changes that you make to them.
Touch	This is similar to Latch, but stops making changes to envelope points when you stop adjusting them. If using a MIDI controller, however, you may find that Touch mode functions in the same way as Latch mode.
Latch	Writes and remembers any changes that you make to settings, and creates new points on existing track envelopes. Changes commence when you first adjust a setting, and continue to be remembered until playback stops.
Latch Preview	This mode enables you to try out changes to parameter values (e.g. volume level or pan position) without actually writing them to envelopes. When you are happy with your parameter settings you can then use an action to write them to your envelope(s). Because this concept can be difficult to grasp at first, it will be considered in a section of its own, after this section.

Up and Running: A REAPER User Guide v 5.24

Automation Mode	Description
Write	Writes and remembers current settings as edit points, along with any changes that you make to settings for armed items during playback. <i>In this mode, previously written envelopes for armed items will be over written.</i> REAPER's Automation preferences include an option to automatically switch to another mode immediately after recording automation in Write mode. By default, it will switch to Trim/Read.

When you are in Latch, Touch or Write mode, an envelope can also be armed by clicking on the **Arm Record** button in its automation lane (where one exists). Remember also after using Write, Latch or Touch mode to change to Read or Trim/Read mode, to prevent further automation from being accidentally recorded.

A number of **actions** are available in the Actions List for smart editing existing envelopes after first setting the envelope(s) to **latch**, **touch** or **write** mode. These allow you to copy the value of an envelope (or envelopes) at the current cursor point all the way to the start of a project or all the way to the end of a project, or to a time selection. To see a full list of these actions, enter **auto write** into the Actions List filter box. Some of these will be examined in the next section, Latch Preview Mode.

Here is an example.

This track has a volume envelope, currently in trim/read mode. Note the cursor position. Suppose we want to set the last part to this same volume level.

In the second picture, we have selected write mode and marked as a time selection the part of the envelope that we wish to change.

Finally, we run the action **Automation: Write current values for all writing envelopes to time selection.**

The envelope in this section is now set to the desired level.

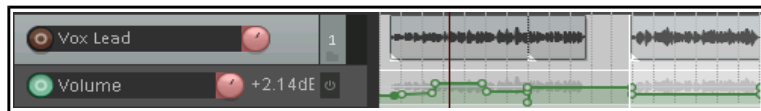
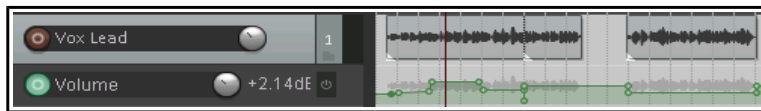

18.9 Latch Preview Mode

This mode enables you to try out changes to parameter values (e.g. volume level or pan position) without actually writing them to envelopes. When you are happy with your parameter settings you can then use an action to write them to your envelope(s). Let's start by working thru a relatively simple example, before introducing some of the other options that are available.

Example

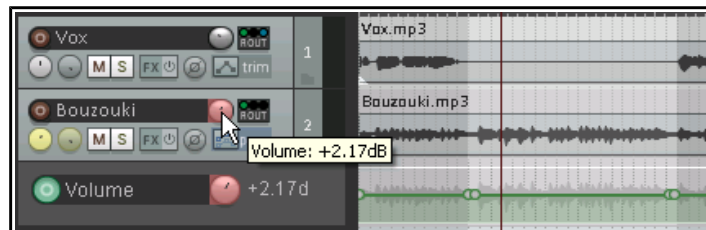
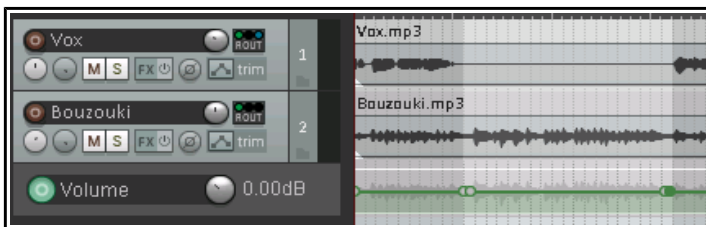

1. Here we have a song with an instrumental break. We want to increase the volume of the featured instrument during the break, but by how much? (For ease of illustration, other instrument tracks are not shown).

We have added a time selection and a volume envelope to the track and inserted two points at both the start and end of the break.

2. We play the song, adjusting the volume control until we are happy with the level (in this case at +2.17dB). We can keep adjusting this until we are happy with the level: notice, however, that the envelope is not yet adjusted.

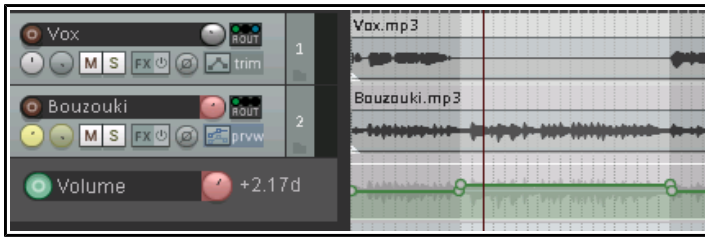

3. We now display the actions list (**Actions, Show action list**) and run the action **Automation: Write current values for actively-writing envelopes to time selection**. The envelope is now adjusted. Finally (not shown) we can reset the track automation to trim/read mode.

You might want to work using latch preview mode on more than one envelope on a track, or indeed on more than one track. You might want to use “write to” options other than to time selection. Keeping this in mind, here is a summary of the main actions available. Remember that these can be assigned to keyboard shortcuts, toolbars, and/or menus (see Chapter 15).

Set automation mode actions:

- Automation: Set track automation mode to latch preview**
- Automation: Set all tracks automation mode to latch preview**
- Global automation override: All automation in latch mode**

Automation write actions:

- Automation: write current values for actively-writing envelopes to [entire project or time selection]**
- Automation: write current values for actively-writing envelopes from cursor to [entire project or first touch position or start of project]**
- Automation: write current values for all writing envelopes [from cursor to end project or from cursor to start of project or to time selection]**

Latch clear actions:

- Automation: Clear [track or all track] envelope latches**

These options together should provide you with all you need for your latch automation preview requirements.

For a greater in-depth understanding of this and other advanced automation features, go to <http://wiki.cockos.com/wiki/index.php/AdvancedAutomation>

18.10 Global Automation Override

The Global Automation Override (**Global Auto**) button on the transport bar can be used to apply global options to your envelopes. Right click on this button to display the menu which can be used to:

- Toggle bypass on/off for all envelopes.
- Select a single automation mode (such as Trim/Read or Read) for all tracks.
- Toggle display of all active envelopes.

A global option can be removed by the **No global override** command. Each track will then be returned individually to its former state, with its previous individual automation mode and bypass settings restored.

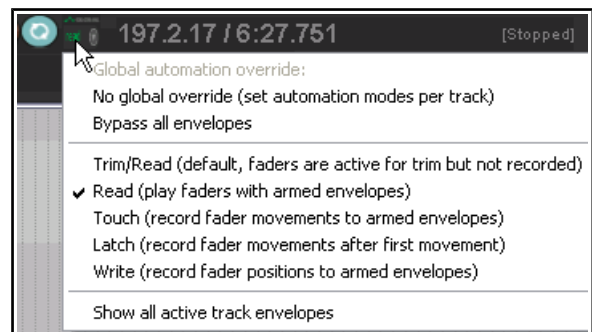

18.11 The Envelope Panel Controls

The envelope panel's fader is used to write automation (write, latch or touch modes), show automation changes (read mode) or adjust the parameter value for the entire track or selected envelope segment (trim/read mode). In the default theme this is a rotary control. When a track has other envelopes that are not displayed in lanes, you can click on the envelope name (in the example shown this is Volume) and choose from the list a different envelope to display in its place.



Up and Running: A REAPER User Guide v 5.24

Other controls are the **Bypass** toggle and next to that the **Hide/Clear** button (used to hide an envelope, move it to the media lane, or clear it altogether). FX parameter envelopes may also have some additional controls, for example to enable parameter modulation or learn mode (see later in this chapter and Chapter 19).

18.12 Manually Adjusting Envelopes

As an alternative to writing automation to define and shape your envelopes, you can use your mouse directly within the envelope lane. This is especially useful, for example, when you can see from observing the waveform that there is a peak that needs adjusting. Amongst the actions that you will commonly use for this are:

- **Shift Click** for adding points to an envelope.
- **Ctrl Click Drag** for freehand drawing of envelope points and curves.
- **Click Drag** for moving envelope segments freely up or down or envelope points in any direction.

The first of these actions is executed by holding **Shift** while clicking on the envelope, the third by simply clicking. These can be swapped in your Mouse Modifier (Envelope segment) preferences if you wish. In this example, we will assume that **Click Drag** is used to adjust segments, and **Shift Click** to add points.

In the example that follows, you will use the mouse to raise the volume of your Bouzouki volume envelope a little for the duration of the short instrumental break that occurs between the second and third verses. You will then draw an automation curve over part of the vocal track. This example assumes that the default mouse editing behavior settings are as shown above.

Example

1. Hover your mouse over the envelope, just before the start of the second instrumental break. This will be at or near 1 min 36 seconds. The mouse will change to a vertical double-headed black arrow.
2. Hold **Shift** while you click the mouse on the envelope to create a point.
3. Repeat this three times as shown (right), so that you have two points just before the break and two points just after it.
4. Now hover the mouse anywhere between the second and third point. Click and hold down the mouse, then drag upwards to raise the volume of this envelope a little, as shown in the second illustration. Save this file.
5. Display the track's Envelope Window and make sure that automation mode for this track is set to **Read** and that the **Volume** envelope is selected and set to **Visible** and **Arm**.
6. Play the song. The Bouzouki volume will now be faded up for both instrumental passages and then down after them.
7. Now select the **Vox** track and press **V** to display the Volume envelope for this track. Zoom to the passage from about 1 min 0 sec to 1 min 19 secs. We are going to make this passage a little louder.
8. Hover the mouse just above the envelope at 1:00. Hold down the **Ctrl** key. The mouse cursor will change to a pencil. Still holding **Ctrl** drag the mouse along to about the 1:19 mark (see above right) then release the mouse. This will draw changes to the volume envelope.
9. Remember that any excessive points that have been inserted by this action can be removed (as in the earlier exercise) using the **Reduce number of points** command. Save the file.

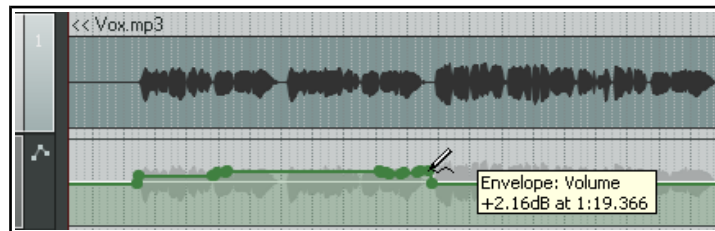
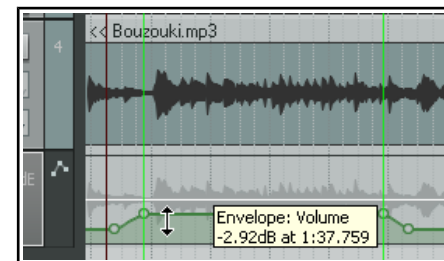
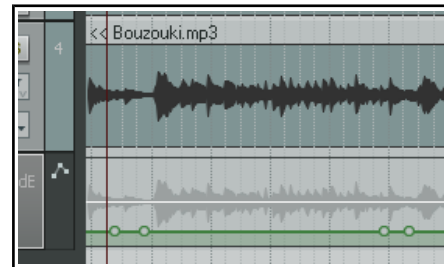

Note: Amplitude vs Fader Scaling

Right-click over a volume envelope for a context menu which includes **Volume envelope scaling** (under the **Envelope defaults** option). Available options are amplitude scaling (the default) and fader scaling, each of which will produce different results. With amplitude scaling, half as high, for example, is half as loud, whereas with fader scaling the envelope height corresponds to the track fader. Fader scaling can make editing the

envelope at low levels of volume easier. Changing your preference on an envelope after points have been added will affect the sound level produced by that envelope.

You can change the default setting from amplitude scaling to volume fader scaling on the **Options, Preferences, Project, Track/Send Defaults** page. You should also familiarise yourself with the various options under **Preferences, Editing Behavior, Envelope Display** (see Chapter 22)

18.13 Using the Mouse with Envelopes

The above exercise has introduced you to some examples, but there are many other techniques and mouse tricks that can be used for manipulating and managing envelopes and their nodes. This table is a summary of the most important. For a fully comprehensive list, consult the Mouse Modifiers page of your Preferences.

In order to do thisyou need to do this
Select all points on envelope inside time selection.	Click and drag in envelope lane (not on envelope itself) to create time selection.
Draw and shape envelope in freehand mode.	Ctrl Drag anywhere on, above or below the envelope
Add a point.	Shift Click on envelope
Delete envelope point.	Alt Click on any envelope point
Select multiple envelope points.	Hold Ctrl and click on envelope points one at a time
Select all points in an envelope.	Click on any point in an envelope, then press Ctrl A
Select all points within the lasso area.	Click on a point, then use right-click-drag to lasso (marquee) a portion of an envelope. Release mouse
Apply an envelope command to a selection of points.	When you have several points selected, right click over any selected point
Move a point or selection of points freely.	Click and drag any point in the selection.
Finely adjust a point's vertical position.	Ctrl Alt Drag on any envelope point
Allow an envelope point to be moved vertically or horizontally only.	Click and hold mouse on any envelope point, hold both the Ctrl and Shift keys while then dragging any envelope point either vertically or horizontally.
Reset point to center (default value).	Double-click on envelope point

Most of these defaults can be changed in your **Editing Behavior, Mouse Modifiers** preferences settings.

18.14 Envelope Edit Mouse Modifiers

This probably won't be the very first thing you'll want to do, but after you have been working with envelopes for a while you might wish to consider changing some of the default mouse modifier settings so as better to suit your personal workflow. There are several contexts relevant here – Envelope lane (left click) , Envelope segment (left drag), Envelope point (left drag), Envelope segment (double-click) and Envelope point (double-click).

For example, if you manually add points to envelopes a lot, you might wish to consider changing the default behavior for Envelope double-click from *Reset point to default value* to the action *Envelope: Insert new point at current position*.

If horizontal adjustment of envelope points is important to you, consider assigning *Move envelope point horizontally* as one of your envelope point modifier instead of just *Move envelope point*.

Also, by default, double-clicking on an envelope's control panel will cause all points on the envelope to be selected. This too can be changed. There's more about mouse modifiers in Chapter 15.

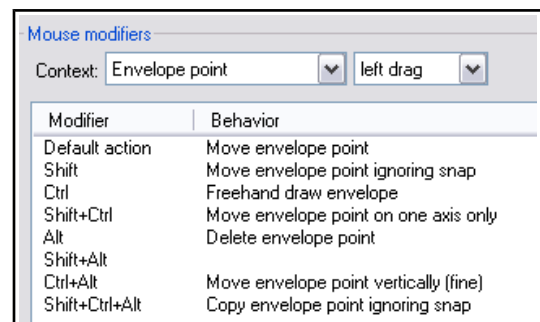

18.15 Managing Automation Envelope Display

REAPER offers you a flexible range of options to determine how you display your automation envelopes. For any track or track you can choose to:

- Display all automation envelopes in separate lanes, or
- Display all automation envelopes over the media items, or
- Display some envelopes in lanes and others over the media items, or
- Display some envelopes and hide others, or
- Hide all automation envelopes.

In the example shown here, a track is displaying three envelopes. – one each for Pan, Track Volume and the volume of a send to an FX bus. One of these – Pan – is displayed on top of the actual media items. The other two each have their own lanes. The Peaks/Waveforms preferences option to **Draw faint peaks in automation envelope lanes** has been enabled. The summary table explains how you use these options.



You should also check the preference (Editing Behavior, Automation) **When adding volume/pan envelopes, apply trim to envelope and reset trim**. Your safest option is to set this to **Never** to ensure that the envelope will be placed in the vertical center of the automation lane, thus leaving adequate room both above and below the envelope for manual editing.

In order to do this you need to do this
Hide an individual envelope	Right click over the envelope and choose Hide Envelope from the menu, or ... In the envelope panel, click on the Hide/Clear button and choose Hide Envelope .
Display a currently hidden envelope	Click on the Envelopes/Automation button in the TCP and check the Visible box for that envelope.
Change the envelope displayed in a particular lane	In the TCP, right click over the envelope name and choose another parameter from the list.
Move an envelope from its own lane to over the media item(s)	Right click over the envelope and disable the Show envelope in lane option, or ... Click on the Hide/Clear button in the envelope panel and choose Move to media lane .
Move an envelope from over the media item to its own lane	Right click over the envelope and enable the Show envelope in lane option
Show all visible envelopes in individual lanes	In the TCP, right click over the envelope button and choose Show all visible track envelopes to envelope lanes from the menu.
Show all visible envelopes over their media item(s)	In the TCP, right click on the envelope button and choose Show all visible track envelopes to media lane from the menu.
Show all active envelopes	In the TCP, right click over the envelope button and choose Show all active track envelopes , or ... Open the Envelopes/Automation window and click on Show all active .

In order to do this you need to do this
Hide all envelopes	In the TCP, right click over the envelope button and choose Hide all track envelopes , or ... Open the Envelopes/Automation window and click on Hide all .

18.16 The Envelope Panel Controls

An envelope displayed in a lane can have its behavior and characteristics modified from within the TCP, using its fader, its buttons and its context menu. For example:

- In **Trim/Read** mode, use the horizontal fader to raise or lower envelope for its entire length or for a particular time selection. For example, with no time selection active, sliding a pan envelope's fader control left would cause panning for the entire track to be moved further to the left (maintaining the relative movement between existing points). If a time selection is active, then the envelope would be adjusted only within that time selection.
- Use the **BP** button to toggle bypass on and off.

Right clicking over the envelope name in the TCP produces a menu which includes the following:

- A list of all available envelopes for this track (standard track and send parameters plus any FX parameters). Choose one of these to change the envelope displayed in this lane.
- Various show/hide envelope options.
- A list of automation modes: this is one way to change a track's automation mode.

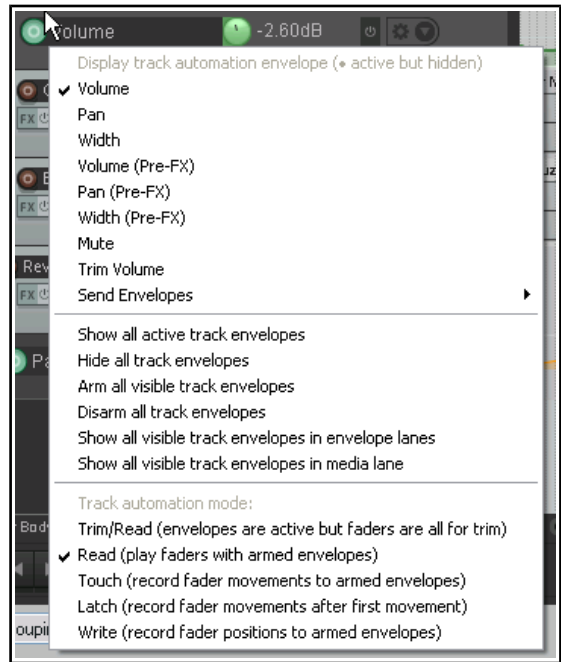

18.17 Managing and Manipulating Envelopes



The Envelope Point and Envelope Segment right-click context menus both contain commands and options that are there to help you manage and manipulate your envelopes. Which of these two menus will appear depends on whether your mouse is hovering over an actual point or over a segment when the right button is clicked.

In the table below, those commands which are on the Envelope Point menu only are indicated by **(P)**.

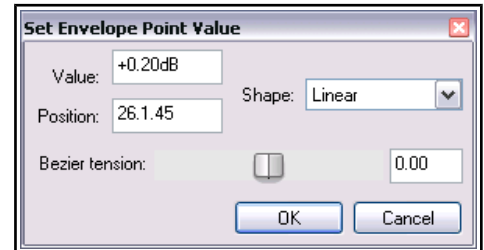
Command	Explanation
Envelope defaults, Default point shape	Sets default shape for new envelopes. The available shapes are Linear, Smooth, Fast Start, Fast End, Square and Bezier. These are explained in more detail shortly.
Set point value ... (P)	Displays the Set Envelope Point Value dialog box. Can be used to changes the value, position, and/or shape of the current point. Optionally, you can assign Double Click (under Preferences, Mouse Modifiers, Envelope Point) to Open envelope point editor .



Up and Running: A REAPER User Guide v 5.24

Command	Explanation
Set point shape (P)	Changes the shape of the current point. The six available shapes are Linear, Square, Smooth, Fast Start, Fast End and Bezier. These are explained in more detail shortly.
Set shape for selected points	Allows you to choose a shape for multiple envelope points. The six available shapes are Linear, Square, Smooth, Fast Start, Fast End and Bezier. These are explained in more detail shortly.
Select all points	Selects all points in current envelope.
Unselect all points	Unselects all points in current envelope.
Select all points in time selection	If a time selection is currently active, all points on this envelope that fall within the time selection will be selected.
Copy points	Copies all points in current selection into clipboard. Note: To apply a command to an existing selection of envelope points, you should hold Shift while you right click over the envelope. This ensures that the selected points remain selected when the context menu is displayed.
Cut points	Cuts all points in current selection into clipboard.
Delete point (P)	Deletes the envelope point.
Delete selected points	Deletes all envelope points in current selection.
Delete points in time selection	If a time selection is currently active, all points that fall within the time selection will be deleted. Shown here is a selection of points before and after using this command. 
Invert selected points	Causes all selected points to be inverted relative to their neutral position. For example, a point on a Pan envelope set at 50% left would be changed to 50% right. When items such as Volume use a logarithmic scale, the calculation is less obvious.
Reset select points to zero/center	Sets all selected points back to a neutral position. Shown here is a selection of points before and after using this command. 
Reduce number of points ...	Reduces the number of envelope points within a time selection or for the whole envelope. This has already been explained in detail.
Arm envelope for recording	Toggles armed status of envelope on and off.
Show envelope in lane	A toggle command which moves the envelope into or out from its own envelope lane.
Hide envelope	Hides the envelope but keeps it active.
Bypass envelope	Toggles an envelope's bypass status.

Command	Explanation
Clear or remove envelope ...	Clears all points on an envelope, restores it to a straight horizontal line. You will be asked if you wish also to remove the envelope.

18.18 Envelope Shapes

Envelopes can be any of six shapes – **Linear**, **Square**, **Slow Start/End**, **Fast Start**, **Fast End** or **Bezier**. To change the shape of an existing curve, right click over the envelope point, then choose **Set Point Shape**, then the required shape from the menu. The examples below illustrate the different shapes:

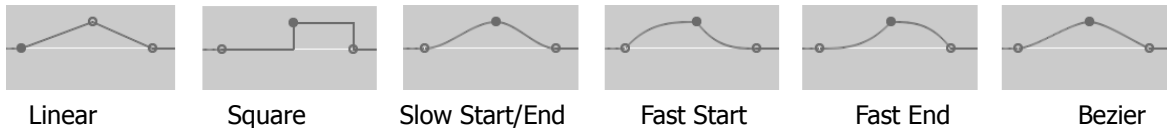

Shapes other than Square are usually best used for graduated parameters, such as volume and pan. Square envelopes are best used for items with on/off parameters (such as bypass or mute), to ensure an exact transition at the required point.

You can specify your preferred default envelope point shape type from the **Options, Preferences, Project, Track/Send Defaults** window, as shown on the right.

18.19 Envelopes in Track Templates

Whenever you save a track (or selection of tracks) as a track template (**Track, Save tracks as track template** command) there is an option in the dialog box to **Include envelopes in template**.

18.20 Envelope Preferences

REAPER's envelopes preferences fall into several different categories within your **Options, Preferences** window. These are explained in more detail in Chapter 22. Meanwhile, it's worth taking note of the following.

The **Appearance** pages of your **Options, Preferences** window includes a number of useful options for determining how your envelopes are presented on screen. Turning these options on can improve clarity. In particular, pay attention to the options to:

- Show solid edge on time selection highlight (Appearance page). Makes the boundaries of the time selection more obvious.
- Show guide lines when editing (Appearance page). Facilitates editing.
- Draw faint peaks in automation lanes (Peaks/Waveforms page). Helps to relate an envelope's position in its own lane to the track's volume level.
- Fill automation envelopes (Appearance page): this faintly colors the area below the envelope.

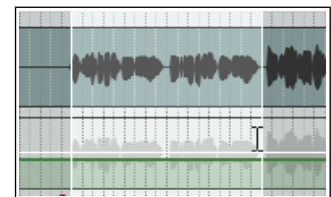

The **Editing Behavior, Automation** page (see Chapter 22) is another important place to go to. It gives you the option, for example, to

Automatically add envelopes when tweaking parameters in automation write mode.

This enables you to create envelopes on the fly without having to select the required parameters from any menu. Be careful when enabling this: you can end up with any number of envelopes that you didn't want!

Finally, a number of the options on the **Project, Track/Send Defaults** have something to say about envelopes. These include:

- Whether to have any envelopes (such as Pan and Volume) automatically displayed for all new tracks.
- Your choice of default envelope shape for new points.
- Your choice of default automation mode for new tracks.
- Whether new envelopes are to be automatically armed.

18.21 Using an Envelopes Toolbar

Chapter 15 explains in detail how to create custom toolbars. If you work a lot with envelopes then this is one area where you can achieve real productivity benefits. Shown here is an example of a simple Envelopes toolbar that you could create. Listed below are the actions attached to each of the icons in the example shown.

- Automation: Set track automation mode to trim/read
- Automation: Set track automation mode to write
- Automation: Set track automation mode to touch
- Automation: Set track automation mode to touch/read
- Envelope: Insert 4 envelope points at time selection
- Envelope: Delete all points in time selection
- Envelope: Clear envelope
- Envelope: Unselect all points
- Envelope: Toggle display of all visible envelopes in lanes for tracks
- Envelope: Show all envelopes for all tracks
- Envelope: Hide all envelopes for all tracks
- Envelope: Show all envelopes for tracks
- Envelope: Hide all envelopes for tracks
- Global automation over-ride: No over-ride (set automation modes per track)
- Global automation over-ride: All automation in trim/read mode
- Global automation over-ride: All automation in read mode



Keep in mind that this is only an example. The same commands and actions that are most useful to one person might not also be most useful to another. In the end, you must decide for yourself.

18.22 Moving and Copying Envelopes with Items

You can choose whether or not to move and copy automation envelopes with media items by setting the option to **Move envelope points with media items** on or off. This is accessed by right clicking on the Envelope tool on the main REAPER toolbar, or by choosing **Envelope points** from REAPER's Options menu. You can use the Actions editor to assign a shortcut key to toggle this action on and off.

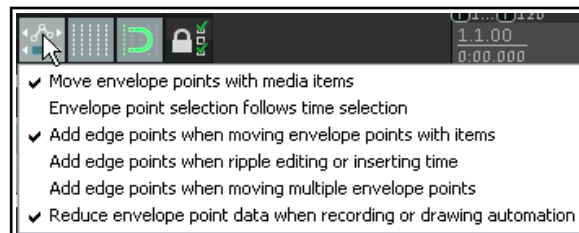

- If this option is turned off, then envelopes will *not* be moved or copied with the media items.
- If this option is turned on, then the envelopes *will* be moved or copied with the media items.

An example of this is illustrated on the right. A selected portion of the media item on the top track is being copied to the track below it using the **Ctrl** drag and drop method.

You can also specify options for **Add edge points** (at the start and end of the time selection) when moving envelope points with items, ripple editing or inserting time, and/or moving multiple envelope points.

In the example shown, not only is the envelope copied with the media item, but also (because the option to show guidelines is also on) there are guide lines displayed which can help you when positioning the item that you are copying.

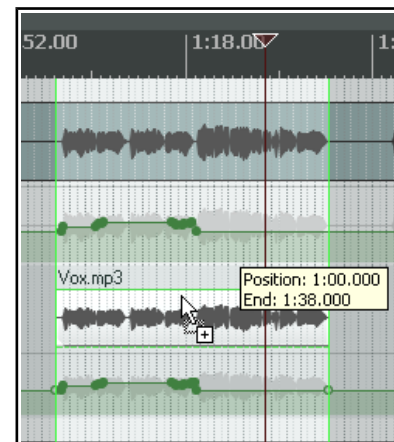

18.23 Automation with Trim Volume Envelopes

The Trim Volume is a special kind of envelope that can be used to fine tune or "tweak" a track's volume envelope. This might be the case, for example, if you wish to experiment with different volume levels before committing them to the volume envelope. Some points to note about trim envelopes are:

- ◆ It is not a track parameter control envelope: it does not correspond to any track control and hence cannot be armed or written in write, touch or latch mode.
- ◆ While it is possible to use a trim envelope on its own, i.e. without also having a volume envelope, this practice is not generally recommended.

As with other automation features, the trim volume's purpose and use can be better explained if we consider a simple example.

Example

In this first illustration, a volume envelope has been added to lower the vox level during part of the song.

On playback, however, we find that perhaps the occasional phrase or word seems to be slightly buried behind an instrumental mix. However, we are happy with this mix and don't want to change it or compress it.

A trim envelope has been added which further adjusts the volume of this track (as shown).

At this stage you could say. "Job done!", but you might instead want to take it one step further, for example, to cement the trim changes on to the track's volume envelope.

REAPER includes the following two actions:

- Track: Apply trim envelope to volume envelope, clear trim envelope,** and
- Track: Apply volume envelope to trim envelope, clear volume envelope.**

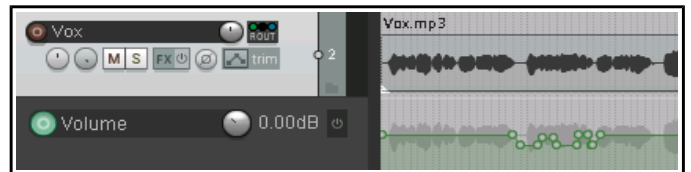
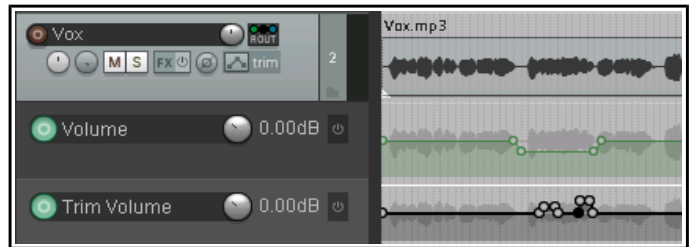
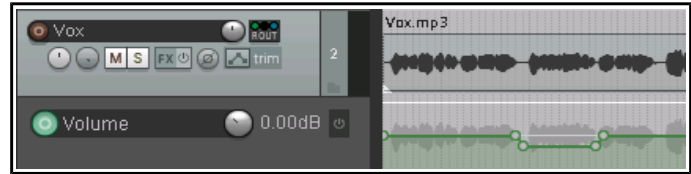

In the above example, you could run the first of these actions to produce the result shown above. The trim envelope could then either be removed altogether, or used to again make further changes to the volume envelope.

18.24 Locking Envelopes

When you are satisfied that your envelopes have been finalised, you can lock them all in order to prevent any accidental changes or deletions from taking place.

Pressing **Shift L** (or right-clicking on the Lock toolbar button) will cause the **Lock Settings** window to be displayed (see right).

You should then select the **Item envelopes** and/or **Track envelopes** options, along with any other aspects that you also require to be locked. You can reverse these settings at any time.

Note that even with your envelopes options selected, locking will only be applied if you also select the **Enable locking** option. The keyboard shortcut **L** can be used to toggle lock enabled status on and off.

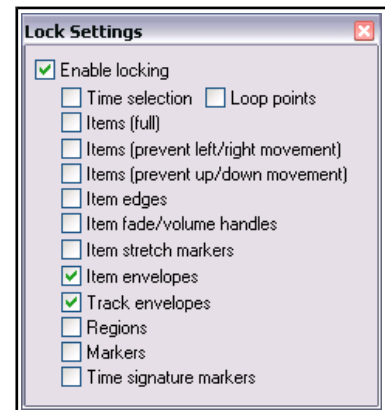

18.25 Automation with Grouped Track Parameters

If you have created track groupings in which you have defined relationships between various parameters, you can ensure that those relationships are maintained (or not, as you wish) when automation envelopes are being written. This is done using the group **Automation Mode** column on the Track Grouping Matrix.

As when the track parameters themselves are grouped, the automation mode status for each track in the group can be set to master, slave, or both master and slave. Here are examples. In each case, the grouping is similar to that used in

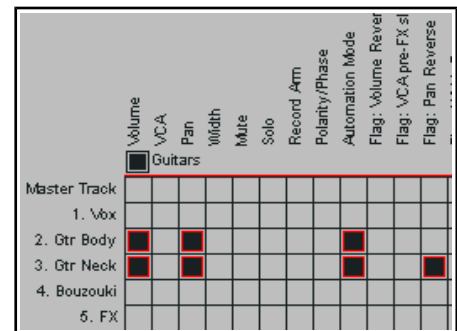

Up and Running: A REAPER User Guide v 5.24

the exercise file **All Through The Night GROUPS.RPP**. If you completed those examples it might help you to open that file now.

Example

In this example, both guitar tracks are set to act as both master and slave in automation mode and both volume envelopes are armed (indicated by the colored circular button to the left of the envelope name, Volume).

You can set either track to write, touch or (as in this example) latch mode and the other will change with it. Any automation movements will then be written to both tracks (see above).

Had the automation envelope been armed on only one of the tracks then the automation would have been written to that track only and not to the other.



18.26 Automation with Track Sends

Automation can be applied to other controls beside Volume and Pan, such as Sends and FX parameters. In this example, we will create a Send, then use an envelope to control it.

Example

1. First, we are going to create an FX Bus Track, then we will use an envelope to vary the level sent to that FX Bus Track from each of the guitar tracks.
2. Create a new track and name it **FX Bus**. Display the FX Chain for this track, and add the FX JS Guitar/chorus. Close the FX window.
3. Select the track **Gtr Body** and drag and drop from its **ROUTE** button to the FX Bus to create a send. Set send volume and pan levels as shown (above).
4. Select the track **Gtr Neck** and display the routing window for this track. Create a send to the FX Bus as a send and set send volume to -10dB and pan to 65% Right.
5. Now display the Envelopes window for the **Gtr Body** track. Set mode to **Trim/Read**. Notice that envelopes are available for your sends. Make sure that **FX Bus Send Volume** is selected, visible and armed.
6. Close this window. An envelope lane for this send will now be visible just below track.
7. Hover the mouse over any part of the envelope, click and drag down until the envelope is set to about -12dB .
8. We are now going to increase the chorus effect, starting just before the second verse.
9. Add a point at about the 60 second mark (Shift Click). Add another point at about 2:30.
10. Hover the mouse over the envelope just after this second point. Click and drag up until the envelope is set to about -7dB . Release the mouse. This is shown below.

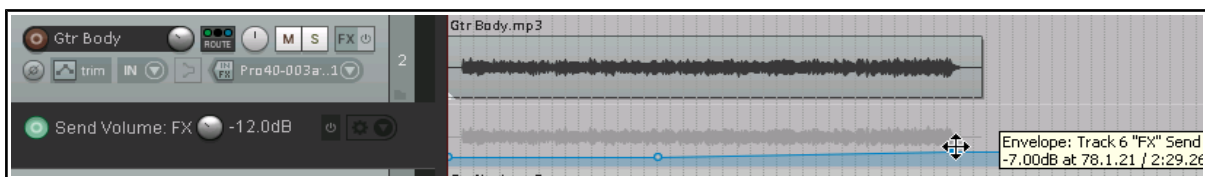
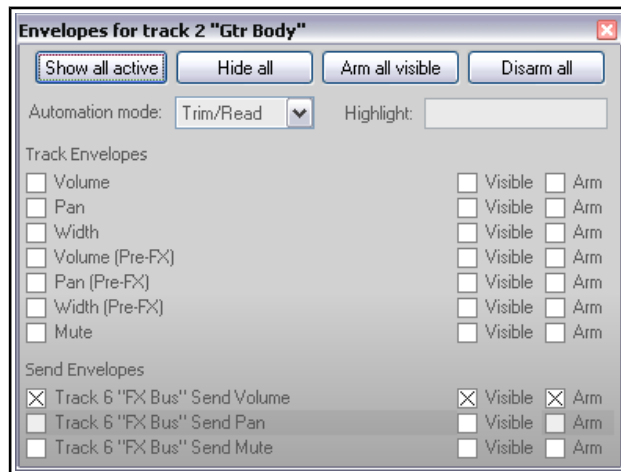

11. Set automation mode for this track to **Read**. Play the song. If you think the Chorus effect is too much, hover the mouse over the envelope, round about 1 minute 30 secs, then click and hold the left mouse button while you drag the envelope back down a little.
12. Now repeat steps 5. to 10. for the track **Gtr Neck**.
13. Don't forget to save the file.

18.27 Automation with FX Parameters

You can create automation envelopes for any parameters for almost any JS, VST, VSTi, DX or DXi plug-in that has been added to any track or item take FX chain. This section focuses mostly on track FX, though the same techniques can also be applied to take/item FX. For example, you can use automation envelopes to vary the level of compression applied to a drum track, or to add more warmth to a vocal take at those times when it is needed. There are three main ways of creating envelopes for your FX parameters:

- Select those parameters for which you wish to add envelopes from the Envelopes window. You may need to click on the small **+** button next to a plug-ins name to display a list of its automatable parameters.
- Right click over background area of any existing envelope lane in the TCP and select the required item from the FX parameters menu. All automatable parameters for all plug-ins in the track's FX chain will be listed on the menu (see right).
- The third method is to create the parameter envelope from within the plug-ins own

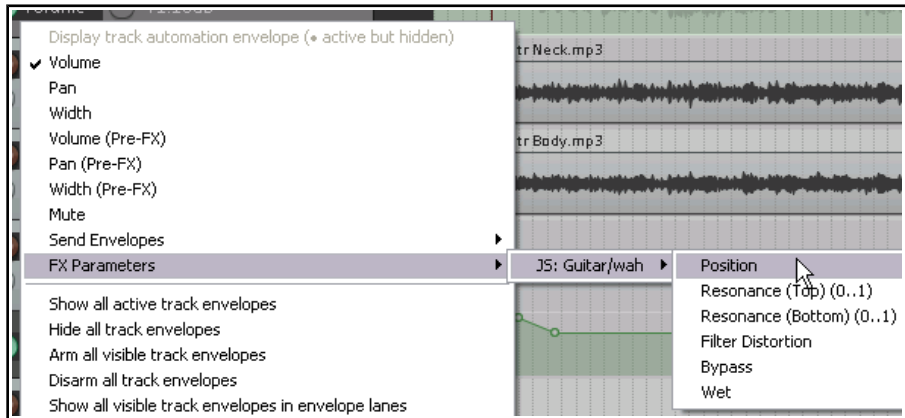

window This is probably the most useful method because in many cases, this will be the environment in which you are likely to find yourself working when you decide that you would like to create the envelope. The standard procedure for doing this is quite simple:

1. Touch the required parameter with your mouse.
2. Click on the **Param** button then choose **Show track envelope** from the menu.

Most FX can be automated in this way, but be warned that especially with some older plug-ins this might not be possible.

Example

1. Open the **FX Chain** window for the track **Vox**.
2. Add the **JS LOSER/4BandEQ** to this chain. Set the first Frequency level to 180 (as shown).
3. Solo the **Vox** track and play the song.
4. As you do so, hold down the **Alt** key and gently increase the Low volume level (the top fader). Notice how the sound changes and becomes warmer. Release the mouse, and the level will snap back to 0.0.
5. We are going to add an automation envelope to increase this level for the phrase *All Through The Night* at the end of the song, from about the 2:14 mark. This will warm up that phrase, but also make it louder. Therefore, we will also need to add use another envelope to lower the volume to compensate.
6. Adjust the horizontal and vertical zooms of the Vox track, so that you can clearly see the area that you are working with.
7. Click on the **Low dB** fader in the EQ then click on the **Param** button. Choose **Show track envelope** from the menu (see right). The envelope will be shown. Unless you have changed the default preferences, this will be shown in its lane.

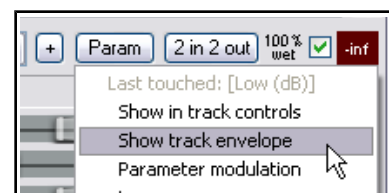
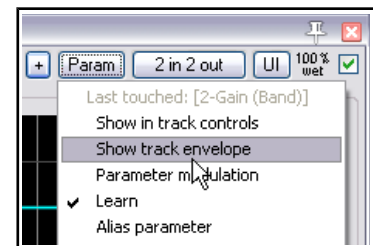

Up and Running: A REAPER User Guide v 5.24

8. Mark as the time selection the last part of the song. Use the rotary fader for this parameter (in the TCP) to raise this envelope in the time selection by about 6 dB.
9. With the time selection still active, use this same technique to lower the fader for the volume envelope by about 2 dB (see below).
10. Play the file. Save it.

Tip 1: To automatically create an envelope for any FX parameter adjusted on the fly during playback, enable the **Preferences, Editing behavior,**

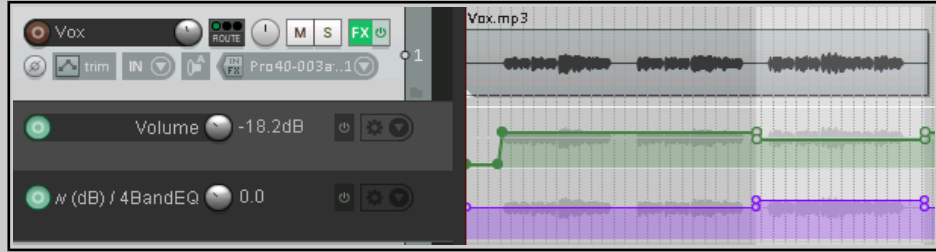

Automation option

Automatically add envelopes when tweaking parameters in automation write modes, then set track automation mode to touch, latch or write.

Tip 2: To add a parameter adjust/control button for any FX parameter to the track's control panel simply select the **UI** box in the track's envelopes window. This allows you to create or modify envelopes on the fly without needing to open the FX window.

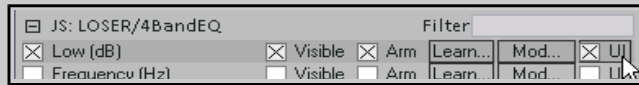

18.28 FX Parameter Automation in Learn Mode

If you are using REAPER with a control surface, such as a Behringer BCR2000, you can use it in Write, Latch or Touch mode to create automation envelopes for FX parameters. You can use the device's rotaries, faders or buttons (as appropriate) for this purpose. Each device is different, but here is an example:

1. Within the plug-in window, click on the parameter, then on **Param** then on **Learn**.
2. Tweak the button, knob, or fader on the control device. A confirmation message will appear in the Command field.
3. Select a CC mode: usually this will be absolute or one of the relative options. Consult the device's documentation: if in doubt, try **Absolute** to begin with. For smoother operation, choose **Soft takeover**. Toggle mode is also available: this allows FX parameters to be toggled on/off with a single mapping.
4. Optionally, select **Enable only when effect configuration is focused**. This allows you to assign the same control to another parameter in a different plug-in.
5. When the **MIDI/OSC Learn** dialog box is shown, tweak the control on the external device, select the option **Arm envelope for selected parameter** and click on **OK**. Depending on the parameter

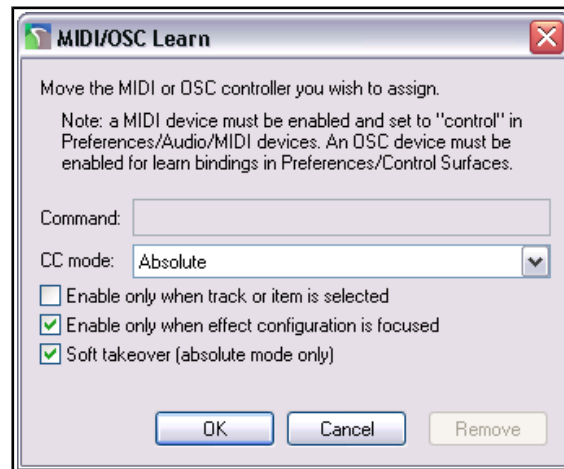

You can now use the control device to write your parameter changes to the envelope during project playback. In Trim/Read mode you can still use the control device to manually adjust the parameter - see Chapter 12.

18.29 Automating a VST with MIDI CC Messages

Depending on what gear you have, there are two other further methods you can possibly use to send MIDI CC messages to automate a VST's parameters:

1. Send MIDI CC from a MIDI source (such as a MIDI keyboard controller, a MIDI track, ReaControlMIDI, or an FX which outputs MIDI CC messages) directly to the VST. In some VSTs MIDI CC messages are hard-wired to specific controls (e.g. LinPlug's Alpha), in others (e.g. AmpliTube, SampleTank 2 and Kontakt) the mapping is assignable.

- Send MIDI CC from a MIDI source to **MIDItoReaControlPath (S&M)**. This injects the MIDI CC messages into the Reaper automation path and onwards to a track VST Parameter Envelope for which MIDI Learn has been used to map the CC message to that envelope. To learn more about (and download) this plug-in, go to forum.cockos.com/showthread.php?t=43741.

18.30 Automating FX Parameters on the Fly

If you turn on the Editing Behavior, Automation preferences option to **Automatically add and arm envelopes when tweaking parameters in automation write modes**, then for any track set to write, latch or touch an automation envelope will be created for you as you tweak the parameter settings during playback.

This feature can be used in conjunction with your control surface. Note that any changes to these parameters that are made on the screen with your mouse will still be applied, as will any changes made using your control surface. Be careful, though, or you could end up creating a whole heap of unwanted envelopes!

Note: When you finish recording automation envelopes in this way, change Automation mode to Read or Trim/Read, otherwise every parameter you tweak will create another envelope, whether you want it to or not.

18.31 Automation with Item Take and Take FX Parameters

Individual media items and takes can be given their own **Volume, Pan, Pitch** and **Mute** envelopes. One way to do this is to right click over the item, choose the **Take** command, and then select your required envelope from the menu. Alternately, click on the item's envelope button (if visible) and make your selection from there. Item buttons can be selected to be displayed from the **Appearance, Media** page of your Preferences window.

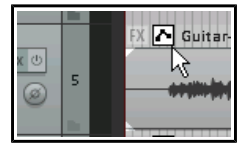

Envelopes with Media Items

In the example shown on the right, a pan envelope has been added to our media item, using the **Take, Take pan envelope** command. The item is panned first away from the center then back towards it.

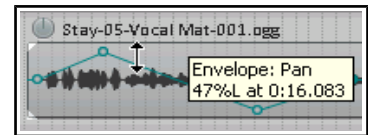

The envelope can be edited with points added, moved, and so on, just like any other. You can right-click over any point or segment of a take envelope to access the context menus. You can also create different envelopes for different takes of the same item.

Envelopes with Multiple Takes

In the example shown here, separate Pan envelopes have been added to the both takes for the last verse of a song, with different FX. The combination of the different panning and the touch of ReaVerbate added to one of the takes can make for an interesting vocal effect when the **Play all takes** option (media item properties) is enabled for this item.

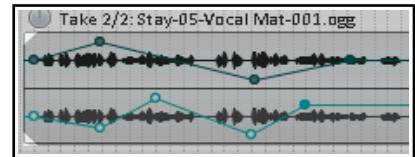

Envelopes with Per Take FX Parameters

Parameters on FX that have been added to individual takes can also be automated. These can be edited manually, with points being added by hand in trim/read mode, or recorded in write, latch or touch mode. The procedures for manually editing or write/recording item/take FX parameter envelopes is essentially the same as those used with track FX parameters. Parameters can be selected for automation in either of two ways:

- From the media item's Envelopes for takes window. This is displayed by clicking on the automation envelopes button (if visible), or by choosing **Take, Take envelopes...** from the take's right-click menu, *or*
- Display the track's FX chain (**Shift E**), select the required FX, then select the required parameter envelope from the **Param** button menu. Note that **Learn** mode is also supported.

Tips: Any FX chain can be copied from one media item to another by dragging and dropping the FX from the first item's FX chain to the second item. An entire chain can be copied by dragging and dropping the item's FX button. Envelopes can then be copied from one media item to another by dragging and dropping the envelopes button.

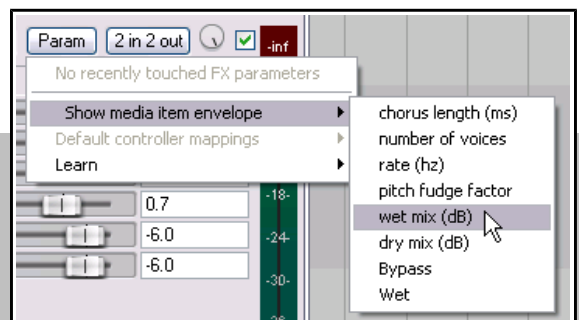

Up and Running: A REAPER User Guide v 5.24

Reminder! You can choose which item buttons you do or do not want to be displayed from the **Appearance, Media** page of your **Options, Preferences** settings.

18.32 Automation with Hardware Output Sends

If you are using hardware output sends with any of your tracks, you will find that you can automate the Volume, Pan and Mute parameters for these sends. These items will appear in the track's envelopes window as shown on the right.

In the example shown, we have a send from Track 1 to an Audio Hardware Output. We can now create an envelope to control the volume of this send.

We can go one better than this. We might wish to use fader movements to shape this envelope, but without using Write mode for any other envelopes that we may also have created. This can be done from within the track's routing window.

Take a look at the screen shot below. The Automation mode has been set to Touch from within the routing window, just for that one envelope.

You could now play your track, adjusting the audio hardware output send fader in the window shown above to adjust the send volume level and create your envelope.

You can also do this with Track Send envelopes.

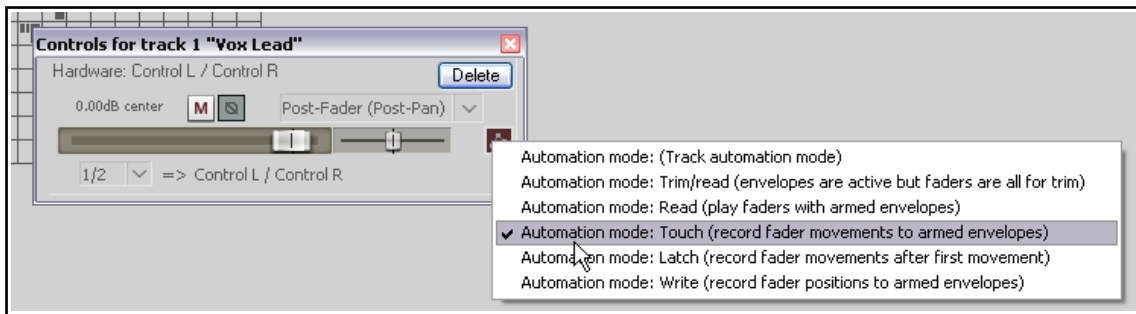
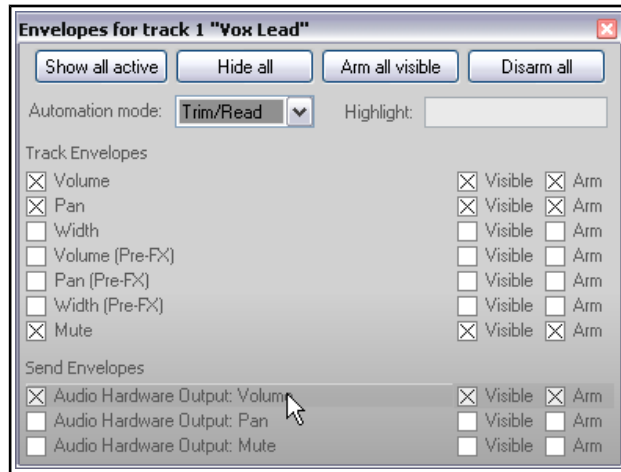

18.33 Automating Automation

Don't forget that REAPER's **Action List** capabilities really do put a lot of power and control at your fingertips. For example, if there's an automation task or sequence of tasks that you use frequently, you can allocate a keyboard shortcut to that sequence.

For example, suppose that you often need for the current track to display and select, ready for automation, a volume envelope, and then select Write automation mode for that track.

You could use the **Actions, Show action list...** command to open the Actions window and create a custom action similar to that shown. You could then assign a keyboard shortcut to that custom action, or add it to one of your toolbars. Refer back to Chapter 15 for more information about custom actions, keyboard shortcuts, and custom toolbars.

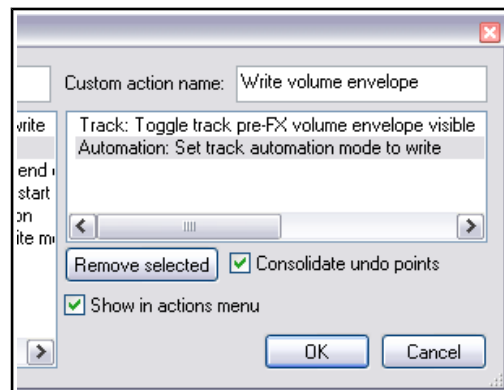

18.34 Actions for Managing Envelopes

In Chapter 15 you were introduced to some of REAPER's actions, and how you can use the Actions Editor and Actions List to assign these actions to keyboard shortcuts and/or custom toolbars.

This list includes very many actions for managing envelopes, including locking/unlocking envelopes, toggling the active status of various envelopes, and selecting specific envelopes. Explore the Actions List for more!

18.35 Automating the Metronome

You can automate the Metronome behavior – for example, to get it to play only at the exact times that you require. To do this, simply create a new track and use the command **Insert, Click Source** to insert a media item into your file. You can then treat this click track like any other track – for example, add a mute envelope to mute certain passages, and so on.

To modify any of the click track properties, right click over the track and choose **Source Properties** from the menu.

For example, you can change the BPM setting, or use your own sample files to create the beats.

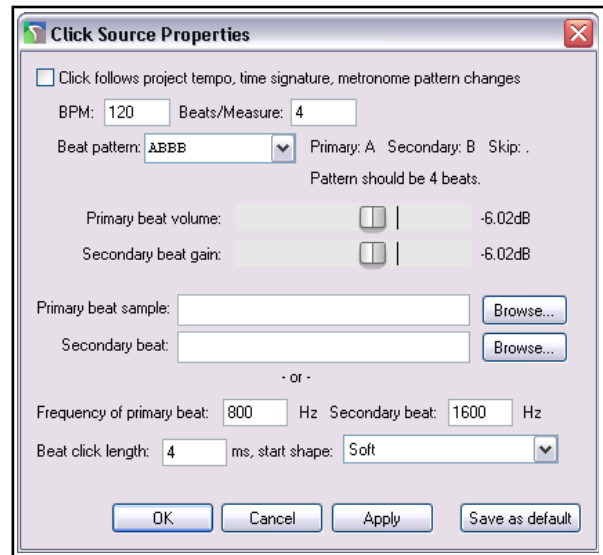

18.36 Tempo/Time Signature and Play Speed Envelopes

In Chapter 10, you learnt how to change time signature and/or tempo within a project. Another (and perhaps more intuitive) way of doing this is to use the Tempo/Time Signature Envelope. To display this envelope in the main REAPER arrange window:

1. Choose the command **View, Tempo envelope** from REAPER's main menu.
2. Set the Automation mode for the Master Track to **Read**.

The Tempo Map envelope range (bpm) can be set in your Preferences, on the Editing Behavior, Envelope Display page (Chapter 22). There you can also specify whether you wish to allow partial measures.



When the Tempo Map is visible, an envelope appears on the Master Track in arrange view. This envelope can be modified much like any other – you can add points, move them, delete them, adjust them, etc. However, the master tempo envelope cannot be modified by freehand drawing. Moreover, editing multiple points at once on this envelope causes each point to be adjusted *pro rata*, not by a constant BPM value.

With each envelope point, a tempo/time signature marker is also inserted on the timeline - editing their values has the same effect as editing the envelope points, and if you move them, then envelope points move with them (and vice versa). REAPER's Actions List also includes an action **Adjust entire envelope tempo...** This opens a dialog box which offers you the options of adjusting the entire envelope by a percentage or by a set number of beats per minute.

You can also add to the Master a Playrate envelope which can be

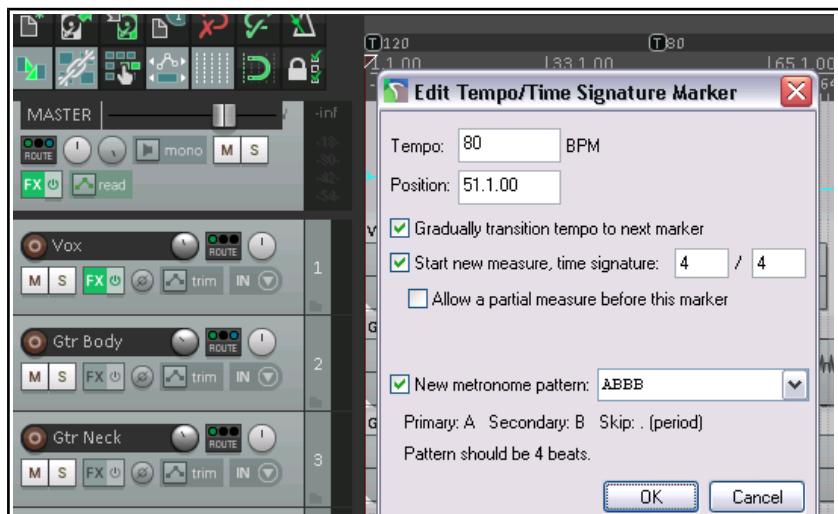

Up and Running: A REAPER User Guide v 5.24

used to automatically speed up or slow down the playback of your project. This envelope is applied to all tracks, audio and MIDI. To do this:

1. Click on the Envelopes button in the Track Master. This displays the Envelopes window for the Master. Now tick the item **Playrate**. Make sure this item is marked as both Visible and Armed.
2. Close this window.

19 Automation with Parameter Modulation

19.1 The Concept

Parameter modulation is best undertaken by more experienced mixers. This chapter serves as an introduction, but inevitably (because of the complexity of the topic) it is not really pitched at the relatively novice user.

Parameter modulation takes REAPER's routing, channel splitting, automation and sidechaining capabilities to new levels. You should probably not attempt this chapter unless you already have a sound grasp of these and other concepts. If necessary, turn back to the chapter **More REAPER Routing Examples** and work thru it again. Parameter modulation at its simplest means using the level of a track's volume or one or more FX parameter to control the behavior of one or more other FX parameters on the same track or on a different track or on a number of tracks. Don't worry if at this stage you find this difficult to comprehend. The concepts of what this is and how it works will become clearer after you have worked thru some examples.

One relatively simple example might relate to the application of a chorus plug-in to a guitar or bouzouki track. Suppose that we wish to vary the wet level of the chorus throughout the track. We could, of course, accomplish this with the use of automation envelopes. However, this might involve quite a lot of work and the envelopes might need frequent readjustments. Let's take this idea a step further. We can define a relationship between the instrument's volume and the wet chorus level, so that as the volume increases the mix becomes drier, and vice versa. The chorus will seem to tail away when the instrument is played more forcefully and become gently more present during the quieter passages. Instead of creating a series of envelopes for our chorus, we can use parameter modulation so that the chorus mix will respond automatically and in real time to changes in volume. Incidentally, this particular example can create an interesting effect of space and distance on the instrument, but as with most of the other examples throughout this User Guide, that is not the main point of the exercise. Changes in an effect like chorus are relatively obvious to the human ear. The main point of this exercise is to show you how parameter modulation is set up and used. It's then up to you to use and apply it in ways that you'll find will bring new life and vigor to your own mixes.

19.2 The Interface

We'll shortly work thru some examples which will show both how parameter modulation works and how you can go about using it. First, we need to introduce a few basic terms and concepts.

When you select a parameter to be modulated, you will initially see the window shown here (right). In this example, parameter modulation is about to be applied to control a compressor's threshold on a vocal track. This initial window features five basic controls. These are:

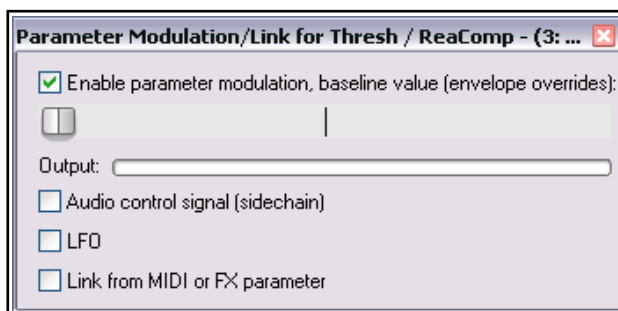

- ◆ **Enable parameter modulation, baseline value.** This needs to be ticked for the parameter modulation (PM) to be applied. Unticking this box sets the PM to bypass.
- ◆ **The horizontal baseline value fader.** This determines the starting value of the parameter being controlled. We'll come to an example shortly. Initially, leave this at its default setting (fully left).
- ◆ **Audio control signal.** Ticking this option will open a window which is used to define both which track (or tracks) contains the audio signal that is to be used to control the parameter being modulated, and how you want the modulation to be applied. Don't worry, we'll get to an example soon!
- ◆ **LFO.** This option allows you to use a low frequency oscillator signal (such as sine, square, triangle, etc.) to generate a tone to control the parameter being modulated. This is more likely (but not exclusively) to be used when it is a synthesizer parameter that is being modulated.
- ◆ **Link from MIDI or FX parameter.** This option allows you to link one FX parameter (on a track or media item) to another. An example might be to ensure that as a track or item is compressed more heavily, some presence is added to the EQ (to compensate for loss of dynamics). Another might be that as the wet/dry balance on a delay effect is adjusted to add more delay, the pan position of the delayed signal is automatically moved further out. The possibilities really are endless.

Linking from MIDI events will be covered separately, towards the end of this chapter.

19.3 Defining a Parameter for Modulation

Parameter modulation can be used with track FX and/or take/item FX.

Illustrated below is an example of the Parameter Modulation window with just the **Enable parameter modulation** and **Audio control signal** options enabled. The table below that explains the main settings, what they do and how they are used. We will then go on to work thru some examples to show you how parameter modulation can be used.

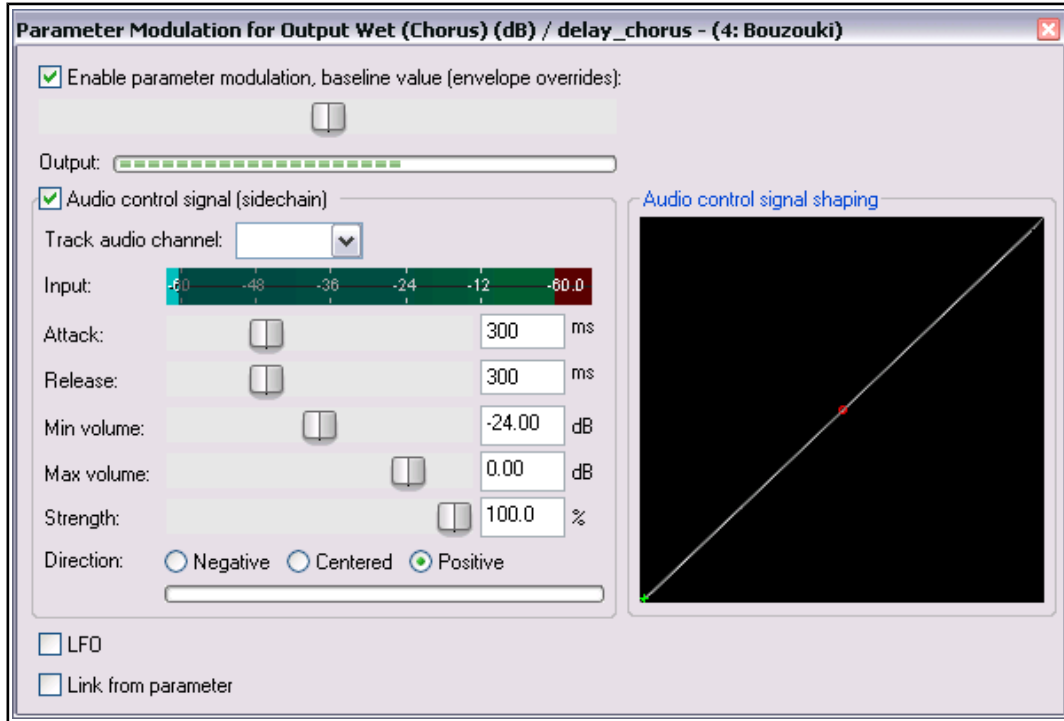

Item	Description
Enable parameter modulation, baseline value with Fader	The checkbox enables/disables parameter modulation on this parameter. The fader sets a default value for the specified parameter that is to be modified. However, if an automation envelope exists for the same parameter then that envelope will determine the baseline and this setting will be ignored.
Audio control signal	Enables/disables control of the parameter by the audio signal in the specified Track audio channel .
Track audio channel	This specifies which audio channel(s) – for example, 1/2 or 3/4 – contain the audio signal that is used to control the specified parameter. The selection of channels available will depend on how many channels have been previously defined for the track. In more straightforward applications, you will want to choose channels 1 + 2. This will ensure that the parameter is controlled by the audio signal on its own track. However, as you will see soon, you can choose a source other than channels 1 + 2 if you want an FX parameter on one track controlled by the audio signal from a different track. The latter case would be an example of sidechain parameter modulation.

19 - Automation with Parameter Modulation

Item	Description
Attack and Release	<p>These two factors determines the speed with which changes in the level of the incoming signal will be applied to the parameter. They work in a similar way to Attack and Release on a compressor.</p> <p>A higher attack setting will cause the parameter to respond more slowly to changes in volume in the source audio channel.</p> <p>A low release speed will cause the modulation to be adjusted rapidly as the volume then falls. A higher speed will hold the modulation for a longer period before doing so.</p> <p>Generally speaking, the higher the attack and the release settings the more gradual will be the parameter modulation response. The lower these settings, the more sensitive and immediate will be the response.</p>
Min Volume and Max Volume	<p>These determine the range within which the signal on the track audio channel will be used to modify the FX parameter.</p> <p>For example, in the illustration shown, the parameter in question (chorus wet mix) on the track in question (track 4, Bouzouki) will only be controlled by the audio signal on channels 1 and 2 when its volume falls within the range - 24 dB to - 0.53 dB. If or when the signal is quieter than -24 dB or louder than - 0.53 dB the parameter modulation is in effect set to bypass.</p>
Strength and Direction	<p>These determine the nature and the intensity of the relationship between the incoming audio signal and the parameter being controlled. For example, set to 100% positive as the incoming audio signal increases or decreases, then the parameter being controlled will also increase or decrease to the same degree. At 50%, the relationship will still be positive, but more moderate. You can think of this as being conceptually similar to a ratio control on a compressor.</p> <p>Likewise, a setting of 100% negative means that as the incoming audio signal increases, the parameter being controlled will decrease in the same proportion, and vice versa. At 50%, the relationship will still be negative, but more moderate.</p> <p>At 0%, the effect will be completely neutral.</p>
Audio Control Shaping Signal Graph	<p>This graphical control helps shape the behavior of the parameter that is being modified.</p> <p>For example, if the direction is set to positive, then pulling the small red handle (in the centre of the diagonal line) on the graph fully to the bottom right corner will result in more modest increases in the value of the parameter being modified.</p> <p>On the other hand, pulling the small red handle (in the centre of the diagonal line) on the graph fully to the top left corner will result in greater increases in the value of the parameter being modified.</p> <p>Don't worry, we'll work thru an example soon.</p>

The best way for you to understand how parameter modulation works is to try it out in practise. This first example will use several of the PM window controls. We will first select a parameter to be modulated, then set its baseline fader level, and then select the required audio control signal. Finally, we will define the relationship between the audio control signal and the parameter being modulated.

19.4 Defining a Parameter for Modification

To select an FX parameter to be modified, follow either of these sequences:

1. Displaying the track's **Envelopes/Automation** window and click on the **+** for any plug-in to display the list of its controls.
2. Click on the **Mod** button for any parameter that you wish to have modified by an audio signal. You will then see a small check box next to the **Mod** text for that item in the Envelopes window (as shown right).
3. Close the Envelopes/Automation window.

Or:

1. Open the track or item plug-in's FX window.
2. With the mouse, click on the control for the parameter that you wish to modulate.
3. Click on the **Param** button in the plug-in window, then choose **Parameter modulation** from the menu that is then displayed (as shown below).

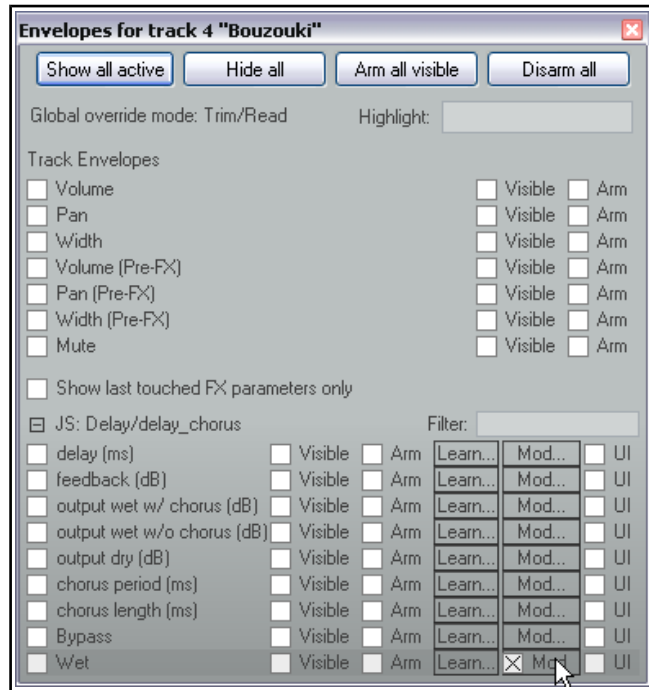

Notice (right) that the name of the last touched parameter – the one to which parameter modulation will be applied – is shown dimmed at the top of the **Param** button menu.

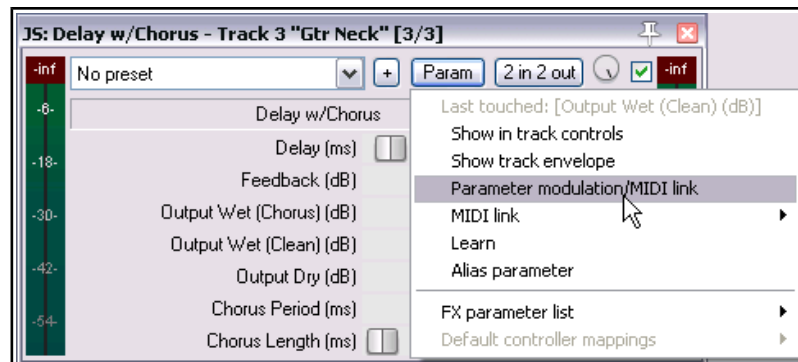

19.5 Parameter Modulation with Audio Control

In this first example, we will insert a plug-in such as chorus into a track's FX chain, then use that track's audio signal to control the way that plug-in behaves.

Example

1. Open the file **All Through The Night** and save it as **All Through The Night MOD1**.
2. Adjust track faders to get a reasonable mix. This could be Volume at -0.5 db, center, Guitar Body at 0 db, 55% left, Guitar Neck at 0 dB, 63% right, and Bouzouki at -4 dB, 15% left.
3. Solo the **Bouzouki** track. While working thru this example, this is the only track that will be needed.
4. Insert the **JS: Delay/delay_chorus** plug-in into this track's FX chain, and set the various parameters as shown here.
5. Click on the **Output Wet (Chorus) (dB) rotary** in this plug-in. Notice that currently this is set at 0.0.

19 - Automation with Parameter Modulation

- Click on the **Param** button, then choose **Parameter Modulation/MIDI link** from the menu. This will open a parameter modulation window for the output wet parameter. Enable the option **Audio control signal** and select as the **Track audio channels 1 + 2**. Play the track.
- The wet rotary on the plug-in was initially at 100%, as shown here. However, as you adjust the baseline fader (in the PM window) while the track is playing, the wet value in the Chorus window (shown to the immediate right of the 2 in 2 out button) is also adjusted. Leave it with a wet mix level of about 50%.
- Set the various items in the **Parameter Modulation** window as shown below and play the track. You should notice the **wet mix** element of the chorus being faded down for louder notes and passages and up for quieter notes and passages.
- Now experiment! You should find that:
 - Moving the **Attack** and **Release** faders left will result in the wet mix chorus fader movements becoming more jerky. Moving them right should make them smoother.
 - Moving the **Strength** fader (negative) to the right will cause the wet mix chorus fader to be faded down for louder notes and down up quieter ones. Selecting positive reverses this.
 - Moving the **Min Volume** fader left will lower the threshold at which the parameter modulation is applied. Moving it right will raise the threshold.
- When you have finished experimenting, adjust the settings to those shown here.

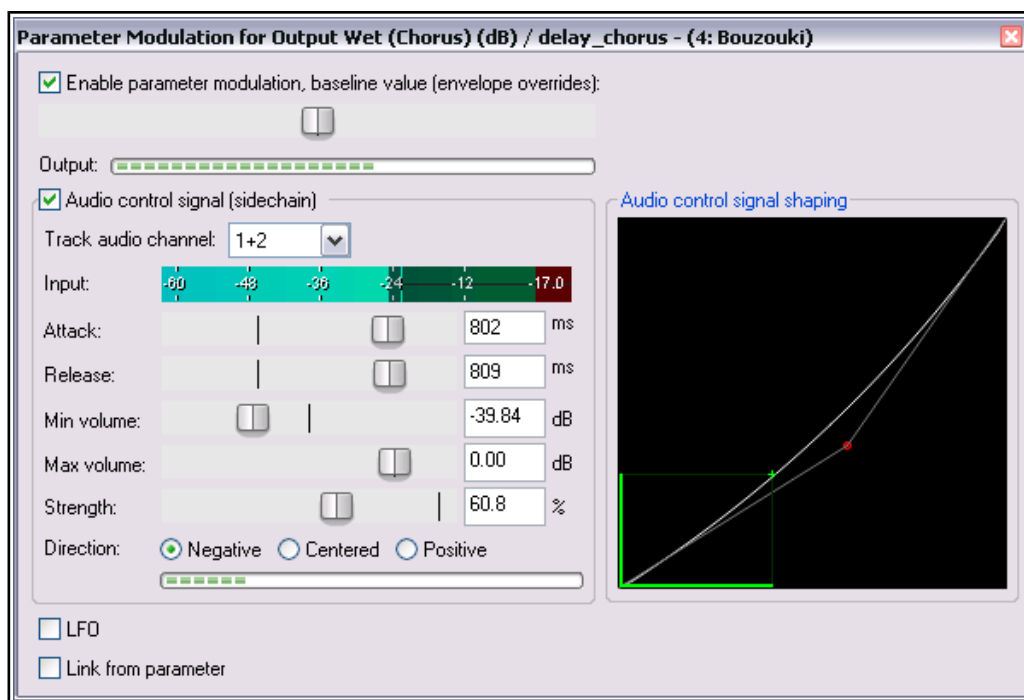
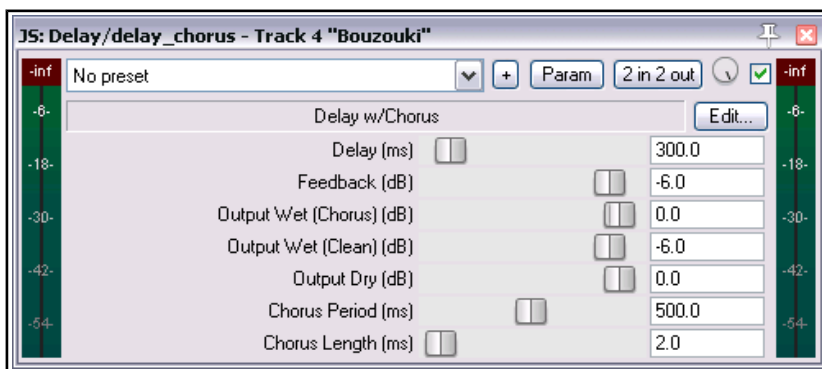

- This instrument becomes louder as the song progresses. Play it, with the Bouzouki unsoloed. By the end, there is less chorus being applied to the bouzouki.

- Now play the song again. Drag hold of the handle on the graph, and use your mouse to drag it to the lower right position. Notice that the movements of the wet mix fader now become more modest.
- Now drag hold of the handle on the graph, and use your mouse to drag it towards the top left corner of the graph (as shown below). Notice that the movements of the wet mix rotary now become sharper and the wet mix level reaches lower values.

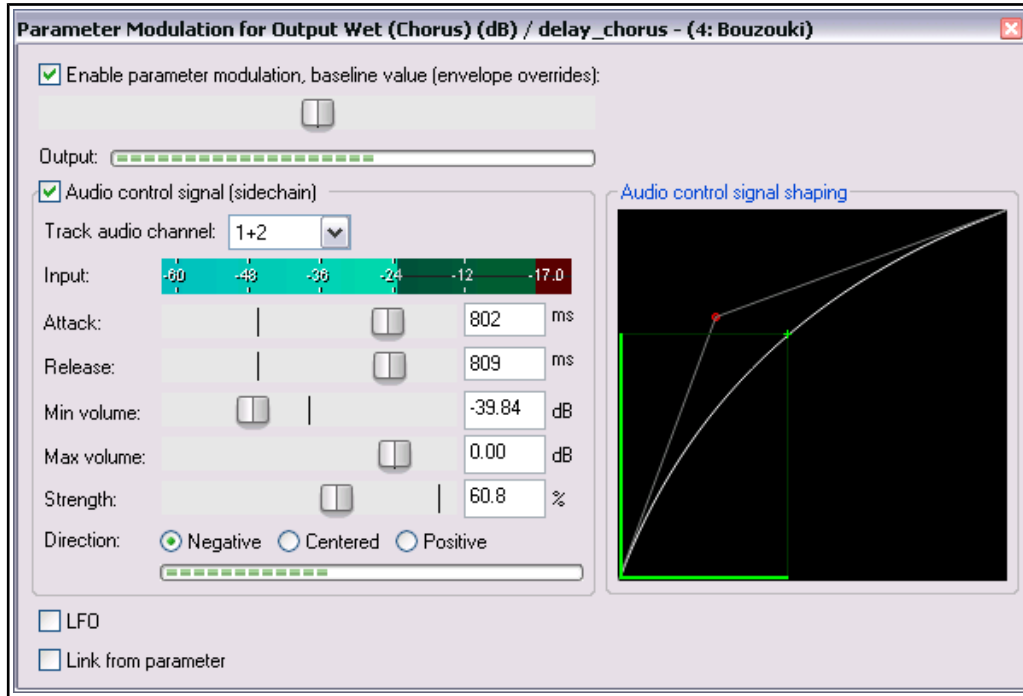

- Restore the graph to its earlier position (shown at step 10) when you have finished. Save the file.

19.6 Using an LFO Shape with Parameter Modulation

Now let's have some fun and use a low frequency oscillator to further modify the way parameter modulation is applied. Try disabling the audio control and turning on the **LFO** option. Start with some fairly conservative settings as shown below. Selecting the **Tempo Sync** option should help make for a fairly safe outcome!

The **Speed** setting controls the signal repeat rate.

Strength determines how much of the LFO signal is applied.

You can also adjust the default **Phase** setting.

As in the previous examples, **direction** can be negative, centered or positive.

Notice also the **Learn phase** button: this can be used to assign control to a MIDI or OSC device.

Compare how the track now sounds with PM enabled and disabled. If you are familiar with working with low frequency oscillators, you might wish to be a little more adventurous. Otherwise, just save the file as **All Through The Night MOD1 LFO**.

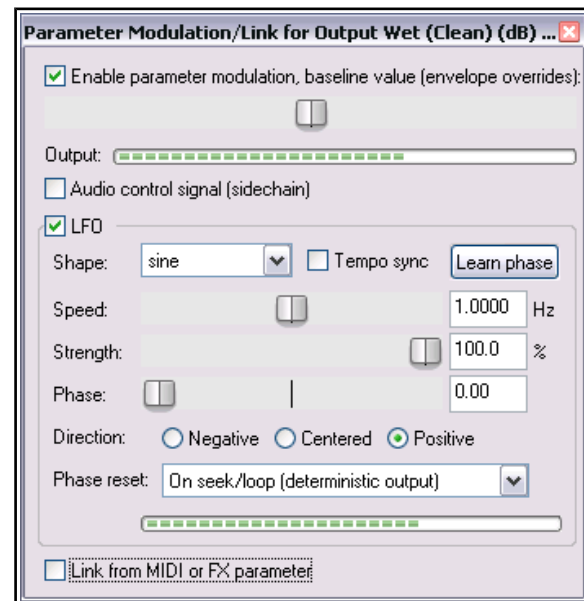

19.7 Using Parameter Modulation for Dynamic Compression

In this next example, you will use parameter modulation to dynamically adjust the settings to compress a vocal track in such a way that the threshold will automatically be adjusted during the louder passages. This gives you a more precise control over the compressor's operation than would otherwise be possible.

Example

1. Open the file **All Through The Night MOD1** and save it as **All Through The Night MOD1A**.
2. Pan the Vocal track to the center and set its volume at about -0.5 dB
3. Insert an instance of **ReaComp** into the FX Chain for the **Vox** track.
4. Set the **Threshold** to about -24 and the **Ratio** somewhere around 4:1. Set **Knee** size to around 15dB. Set the **Wet** gain to about +1.6dB.
5. As you play the song, adjust the settings to suit. One possible set of suitable parameter values is shown on the right.
6. As you play the track you might feel that the compression at times sounds about right but at other times is being applied too heavily. This is where we can use the track's own volume level to control its parameters. In this example, we will do this with the threshold only, but it could also be done with the ratio if you wished to.
7. Click once on the **Threshold** fader.
8. Click the **Param** button for this plug-in.
9. From the menu, then choose **Parameter modulation/MIDI link**.
10. Study the suggested settings shown below and adjust your settings accordingly as you play the song. Refer to the comments below.
11. Notice in particular how the attack and release setting levels, the shape of the curve and the volume settings all help prevent the threshold from being adjusted too radically.
12. Save and close the file when finished.

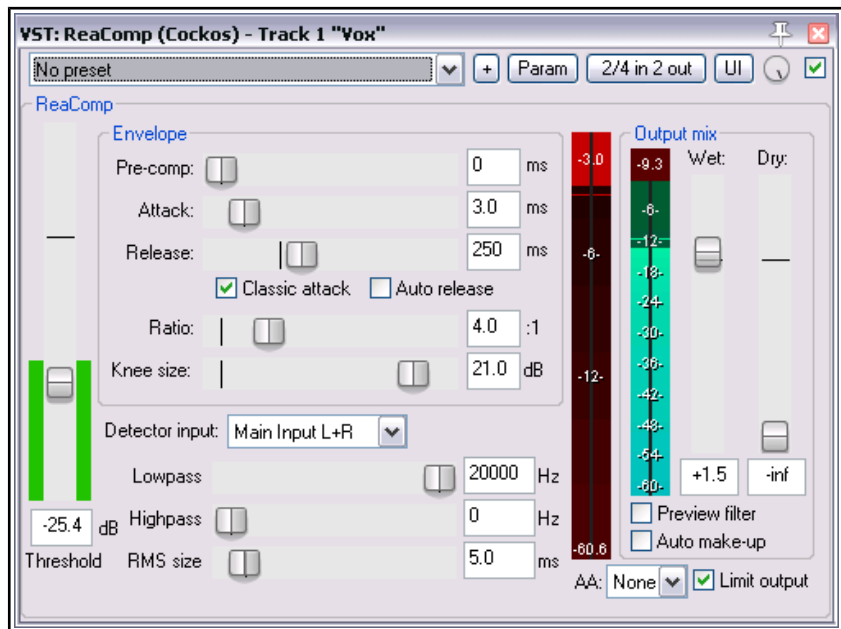

Notes

By setting the Min Volume in the PM window to the same level as the Threshold in the ReaComp window we ensure that the PM is only applied when the vocal is at its loudest. The Strength setting of 33% effectively means that for every 3 decibels by which the volume exceeds the min volume, the threshold will be lifted by about 1 dB.

Note: When you are using Parameter Modulation you should be prepared to tweak the various parameters carefully. Sometimes even the slightest change to a parameter value can significantly change the result. If at first you do not seem to get any result, experiment especially with adjusting the baseline value setting.

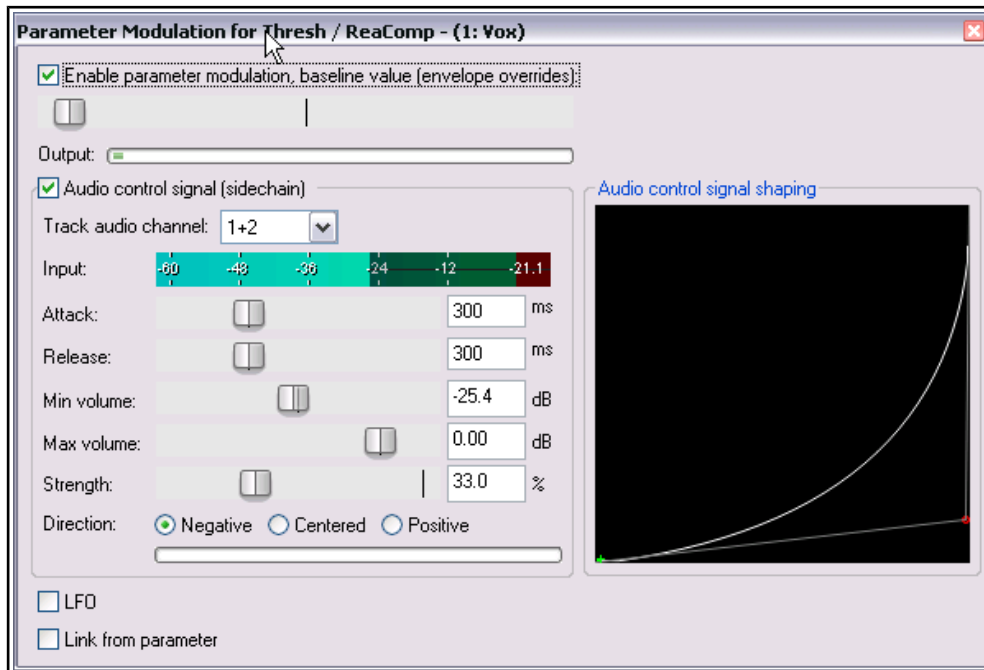

19.8 Bypass Mode

Whenever you create a parameter modulation for a parameter, a small box is added next to its name in the Envelopes/Automation window. This can be used to enable any of your parameter modulations, or set them to bypass mode (in which case they are of course ignored). Otherwise you can do this from inside the Parameter Modulation window itself.

In the example shown here, PM settings exist for the Threshold (currently enabled).

Also, note that clicking on the word **Mod** for an item where parameter modulation already exists will cause that window to be opened (even if it is currently disabled) so that you can view and/or edit the settings.

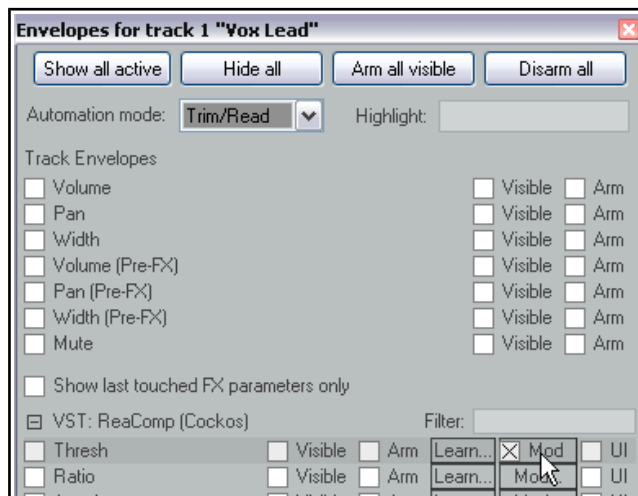

19.9 Parameter Modulation Under Parameter Control

By linking parameters you can use dynamic changes in one FX parameter to directly control another. In this next example you will do just this, linking a track's EQ gain with its compressor threshold, so that whenever the compression threshold is raised a little more warmth is automatically added to the track.

1. Open the file **All Through the Night MOD1A** and save it as **All Through the Night MOD1B**.
2. In the vocal FX chain, add an instance of ReaEQ (after ReaComp). Select Band 2. Set the Frequency to about 180 Hz, the bandwidth to about 2.00 octave and the Gain to 0.0 dB.
3. With the ReaEQ window open, click on the Band 2 Gain control, then the **Param** button, then **Parameter modulation/MIDI link** to open the Parameter Modulation window. Select the option **Link from MIDI or FX parameter**.

19 - Automation with Parameter Modulation

- Click on the large button below the **Link from MIDI or FX parameter** option and choose **ReaComp** then **Thresh** (as shown here).
- Before playing the song, adjust the baseline value fader so that the Gain on Band 2 in ReaEQ is restored to 0 dB.
- Set the **Offset** fader to 10% and the **Scale** to +100% (see notes below).
- Play the song and save the file.

In our first two examples (17. 5 and 17. 6) parameter modulation was used to create quite a dramatic effect. In the last two examples (17. 7 and 17. 9), the effect is far more subtle.

The two controls **Offset** and **Scale** can be used to control the extent to which the controlling parameter (in this example the compressor's threshold) modifies the controlled parameter (in this case the EQ band gain).

The Offset fader increase (to the right) or decreases (to the left) by a specified percentage the value of the parameter being modified

The Scale fader covers a range from -100% to +100%. At -100% the relationship between the controlling parameter (threshold) and the controlled parameter (EQ band 2 gain) will be 100% negative: the EQ gain will be lowered exactly as the threshold is raised. At +100% the relationship will be 100% positive and the opposite will occur.

Parameter modulation is a very powerful feature indeed. You will get the best out of it if you are prepared to experiment and be creative. For example, in the above example you could add a parameter control for another EQ Gain (perhaps Band 3), driven this time directly by the track's audio signal. Another example would be to use, say, the threshold on one compressor to drive directly the threshold on another compressor, independently of audio control.

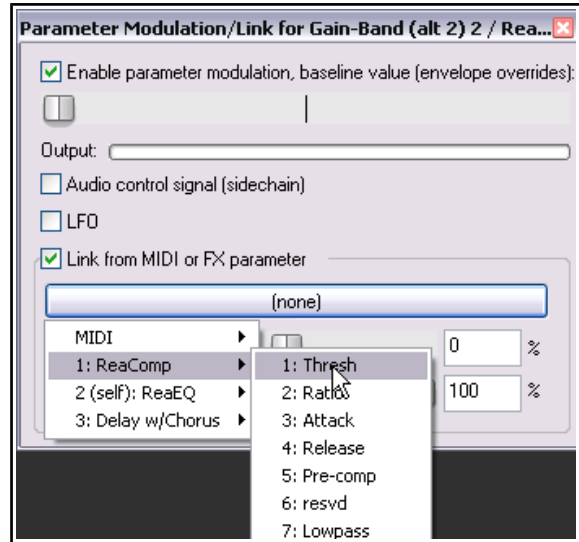

19.10 Using Parameter Modulation with an Envelope

When you have an automation envelope enabled for a parameter being modulated, then the baseline value will be determined by that envelope rather than by the baseline value fader in the parameter modulation window. When this happens, the baseline value that is actually applied will itself vary (according to the envelope) throughout the song. This can produce some interesting results.



Here we have added an envelope to control the **Band 2 EQ Gain** setting of ReaEQ. By clicking the **Modulate** button in the envelope lane we are able to open the Parameter Modulation window and take the necessary steps to ensure that the EQ gain will respond automatically to changes in the strength of the audio signal on this track. In this example, when the envelope is lowered just after the current position of the play cursor, the baseline value of the parameter being modulated will also be lowered.

19.11 Parameter Modulation under Sidechain Audio Control

This next example introduces another application for Parameter Modulation. In this case, we will use the audio signal from one track (a vocal track) to shape the sound of an instrument submix (that is, a folder track containing several instruments). This will be done in such a way as to cause the instruments to appear to pull back slightly during the vocal passages.

Example

1. Open the file **All Through The Night MOD1** and save it as **All Through The Night MOD2**.
2. Remove or set to bypass the delay plug-in in the Bouzouki track's FX chain.
3. Insert a new track after the vocal track. Name this track **Instruments** and make it into a folder. Insert the three instrument tracks into this folder, as shown on the right.
4. Add an instance of **ReaComp** to the Bouzouki track. This is needed only because the volume of this instrument increases quite significantly as the song progresses. We wish to pull this back a little.
5. Set a threshold of around -15dB and a ratio of around 4:1.



6. Select the Instruments folder and display its routing window. Set the number of track channels to 4 and add a receive from channels 1/2 of the Vox track to channels 3/4 of the Instruments folder.
7. Open the FX Window for the Instruments folder and add an instance of **JS: SStillwell/exciter**. This will be used to brighten up the instrument a little.

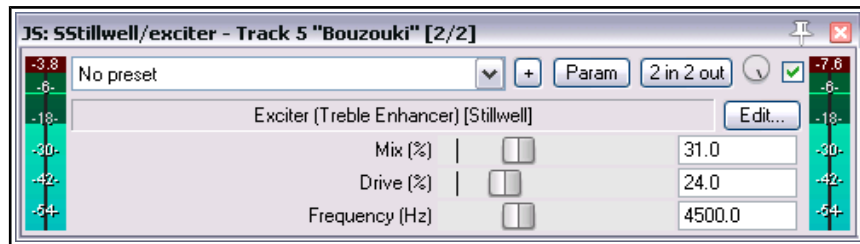

8. Settings similar to those shown here will definitely brighten the instruments, perhaps more than you would like. For the sake of this exercise, however, these levels should be fine.
9. We are now going to use parameter modulation to ensure that audio signal from the vocal track drives down the mix level of the exciter. This will have the effect of helping the vocal to just float over the instruments a little.
10. Click on the **Mix %** control, then on the **Param** button and choose **Parameter modulation/MIDI link** from the menu.
11. When the PM window is opened, enable parameter modulation and choose **Audio control signal (sidechain)**. Move the baseline value fader about a third of the way to the right.
12. Select **Track audio channels 3/4** and make the direction **Negative**.
13. Adjust the other parameters so that as the vocal floats above the instruments the Mix % of the Exciter is smoothly and gently faded down.
14. One possible solution to this exercise is shown below. But don't just dive straight in and copy these settings. Try to get there by yourself!
15. Save the file when you are finished.

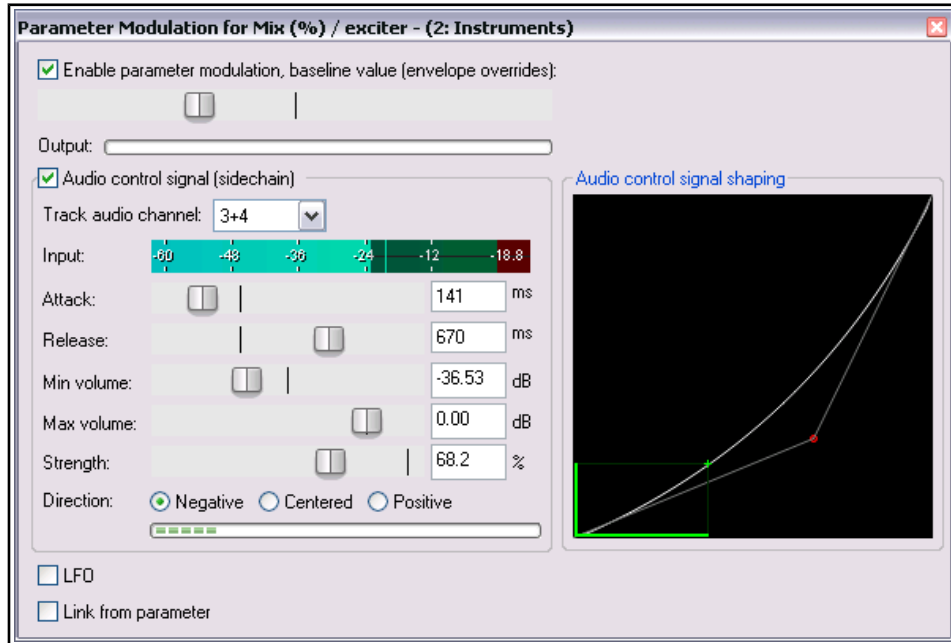

19.12 Using MIDI Links for Parameter Modulation

You can also use MIDI data to control parameter modulation. For example:

- ◆ From a ReaControlMIDI parameter, live or recorded as an automation envelope.
- ◆ From data/events entered or recorded in a MIDI editor CC lane.

For example, you could use an automation envelope to record changes in ReaControlMIDI's volume parameter, then use that envelope to control another FX parameter, such as the ratio setting on a compressor. Another example might be to use a MIDI Editor CC lane to record changes in an instrument's pan position, then adjust the wet/dry mix of an effect such as delay, so as to vary the delay length according to the pan position.

We'll start by looking at these two examples, then you can freely explore any of the many possibilities that are available. For the sake of simplicity, both these examples use DSK Virtuoso. This synth is freeware and very easy to use. If you wish to replicate this example, you can use any synth that you choose.

Example 1: Controlling ReaComp from ReaControlMIDI

1. Create a new project file, add a single track Insert in the track's FX chain first ReaControlMIDI, then a synth of your choice.
2. In arrange view, insert a new MIDI item about 30 seconds long, open the MIDI editor and compose a simple tune. Don't worry about the musicality – just enter enough notes to produce a simple sound.
3. Make whatever changes you wish to the synth parameters, to produce a reasonable sound.
4. Open ReaControlMIDI. Make sure the Control Change section is enabled.
5. Click on the volume control (to make it the last touched item), then click on the **Param** button (top of dialog box) and choose **Show track envelope**.
6. Either record or by manual editing (as you prefer) create an envelope *similar* to that shown below:

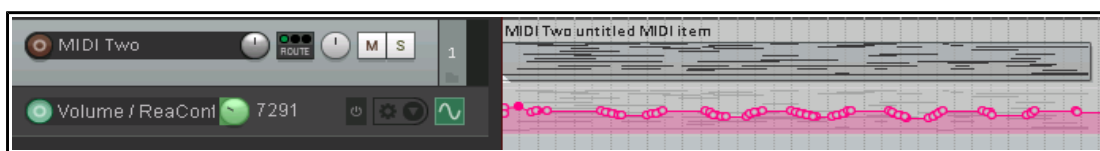

7. At the end of the FX chain, add an instance of **ReaComp**.
8. Play the track. Set ratio to about 4:1 and adjust the threshold to engage the compressor during the louder passages. Return the cursor to the start of the track.
9. Click on the ratio control, then on the **Param** button. From the menu, choose **Parameter modulation/MIDI link**. The dialog shown here will be displayed.
10. Select **Link from MIDI or FX parameter**. Click on the button and from the available options choose **ReaControlMIDI** then **Volume**.
11. The two controls, Offset and Scale have the same purpose as in the examples earlier in this chapter. Carefully adjust the offset control to return the ratio setting on ReaComp to about 4:1.
12. Play the track. Adjust the scale control so as to achieve a gentle movement of the ratio control as the music grows louder and quieter.
13. Save the file as **PMMIDI**. Do not close it.

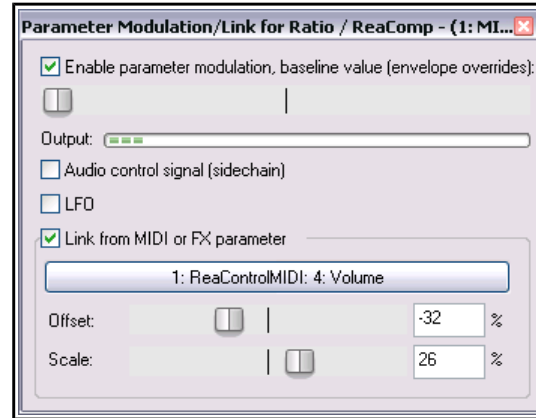

Example 2: Controlling ReaDelay direct from a MIDI CC lane

You could create this example as a separate project or, as we are going to do here, add it to the existing file **PMMIDI**.

14. Open your MIDI item in the MIDI editor. Add a CC lane for **Pan Position MSB** and draw in the necessary events to pan out to the right then back to the center twice or more, as shown here.

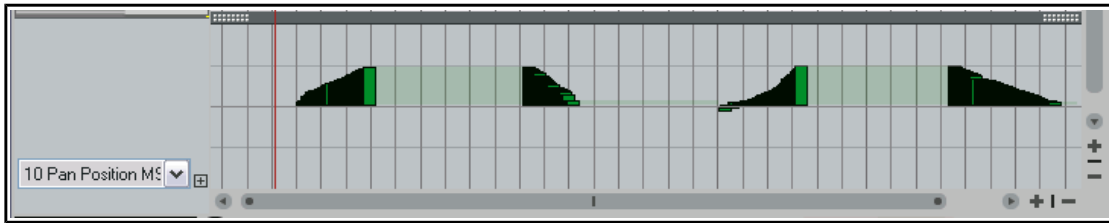

15. In the FX chain, insert **ReaDelay** just before ReaComp. Set length (time) and length (musical) both to 0.0. Set Feedback to about -50.0 dB.
16. Click on the Length (time) control to touch it, then on the **Param** button, then **MIDI link**, then **CC**, then **Pan Position MSB**.

17. The Parameter Modulation/Link dialog will be opened. Click on the large button, then select **MIDI** then **CC** then **Pan position MSB**.
18. Adjust the **Offset** and **Scale** settings so as to get a smooth increase and decrease in the delay length as the pan moves out to the right and back (while the song is played).
19. Save the file!

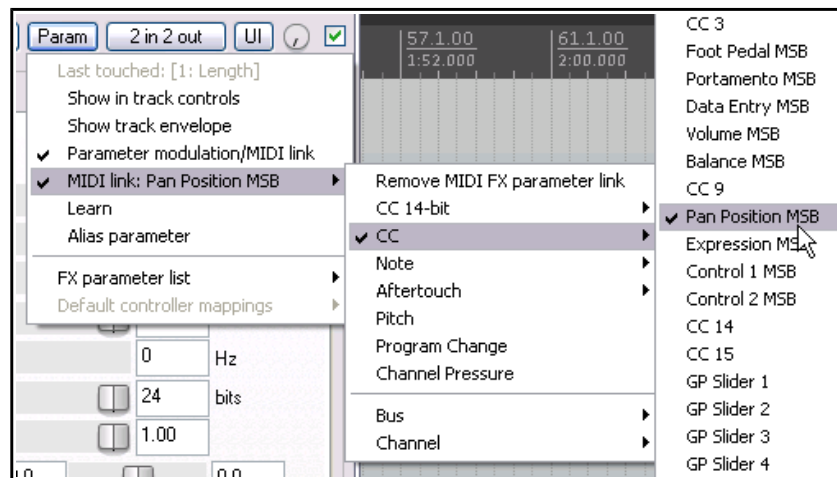

More about MIDI links

In our two examples, we have built our MIDI links using in one case ReaControlMIDI data, in the other case Midi Editor CC lane events. Let's look at some of the other possibilities.

You would have seen this menu when you were creating your links in the earlier examples:

You can link from any of the event types shown on the right.

For CC 14-bit or CC, use the sub menu to specify the event type (this could be any MIDI editor CC lane).

For note or aftertouch, you can select any note.

Other options are pitch, program change or channel pressure.

You can also specify that the parameter modulation is only to be applied to a specified bus or channel.

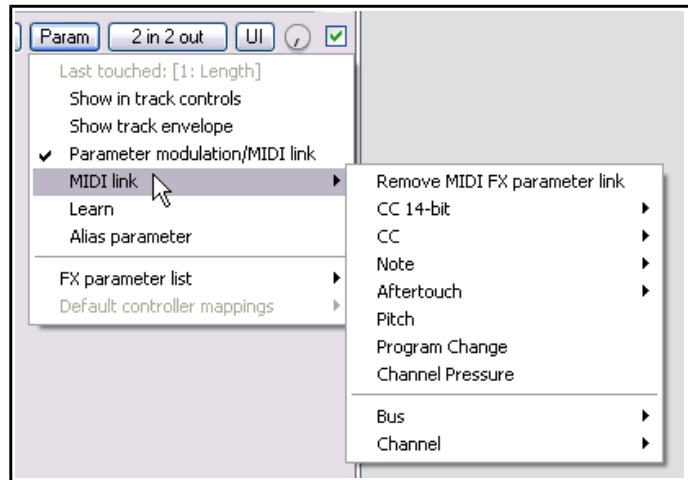

19.13 Further Applications

This chapter has introduced you to just a few basic examples to help you understand what REAPER's parameter modulation is and how it can be used. In doing so we have barely scratched the surface.

Here are some other points to keep in mind:

- With parameter modulation, the signal from any track can be used to control parameters on any other. For example, the signal from an audio track can be used to control parameters on a synthesizer, and a synthesizer's output can be used to control signals on an audio track.
- If you are familiar with working with synthesizers and low frequency oscillators, you may have developed an understanding of different types of waveforms such as sine, square and triangle. You can use these LFO shapes in your parameter modulation. The opportunities here can take you well beyond the introductory example used earlier in this section.
- Other applications for parameter modulation are limited only by your needs, your creativity and your imagination. For example, with this technique you are able to use the audio signal from one track (or group of tracks) to control specific parameters on a noise gate on another track (or tracks).

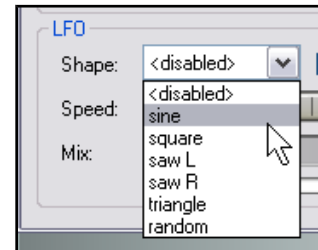

Tip: Your parameter modulation windows and their settings will automatically be saved with any FX chains and/or track templates that you create.

19.14 Managing FX Parameters in the Project Bay

In Chapter 12 you were introduced to the Project Bay, including the **FX Bay** which can be used to help you manage and organize your various track, item and master FX.

The Project Bay also includes a **FX Parameters Bay** whose purpose is to assist you in managing the various FX parameter features discussed in this chapter (and elsewhere). From this single interface you can manage track controls, envelopes, parameter modulation and control surface assignment for all parameters for all active track, item take and master track FX.

The FX Parameters tab is located next to the FX tab of the Project Bay, displayed by the **View, Project Media/FX** command, and shown below.

This bay supports the standard project bay features explained in Chapter 12, including (where appropriate) the various commands on the **Action** and **Options** button, and from right-click context menus. Here we will focus solely on those aspects that are specific to FX Parameter management.

Up and Running: A REAPER User Guide v 5.24

Whenever any of these features is added to any FX parameter (e.g. from the individual FX window, or from the FX bay), it will automatically be added to the FX Parameters Bay display. In the above example, Band 2 gain on ReaEQ on track 1 uses parameter modulation: this is shown in the **Mod** column, which also indicates that they are under the control of audio control signals (**ACS**). The Details column tells us that another parameter on this plug-in, Band 4 gain, is linked to Band 2 gain. The **Envelope** column shows that two parameters from ReaDelay on track 5 have armed and active automation envelopes. Two parameters from ReaComp on track 2 have had their controls added to the track control panel (or **TCP**, as indicated by the dots in this column), and one parameter from a Guitar/chorus plug-in (Track 3) has both a track control and an armed envelope. No parameter is shown in the **Learn** column as being under control surface control.

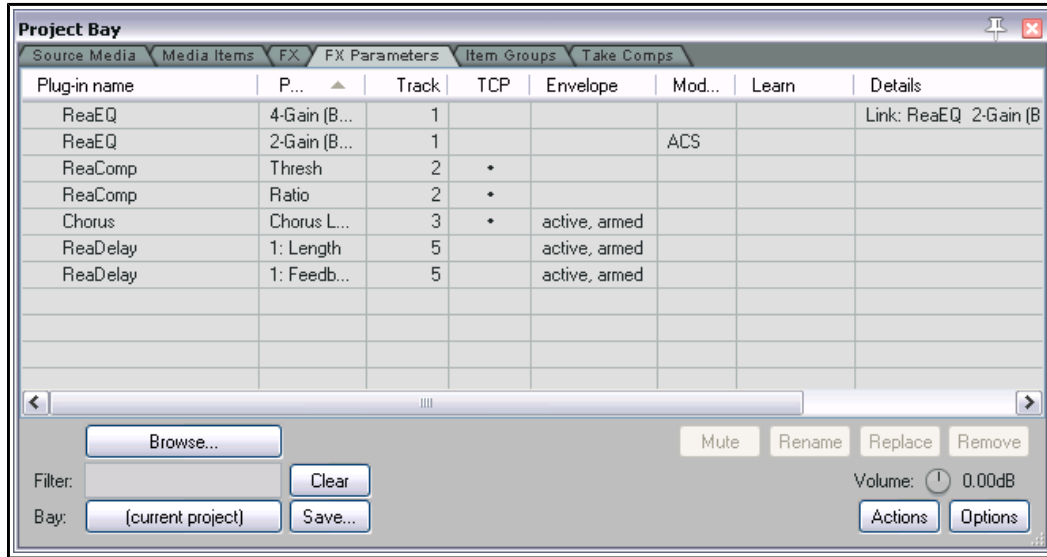

The table below summarises how you the Parameter FX Bay can be used.

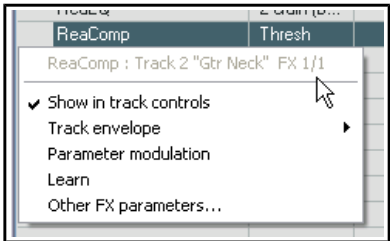
In order to do this ...	You do this ...
<p>Manage or modify an existing parameter's settings</p>	<p>Right-click on the plug-in name and make your choice from the menu. For track FX, these are Show in track controls, add a track envelope, parameter modulation and learn (to assign to a control surface). For item/take FX, the options are track envelope and learn.</p> 
<p>Manage or modify a different parameter on the same FX</p>	<p>Right-click on the plug-in name and from the menu (shown above) choose Other FX parameters... Choose an option (show in track controls, track envelope, parameter modulation or learn) from the sub-menu, then select the required parameter from the list.</p>
<p>Manage or modify a parameter on an FX used in the project but not yet modified</p>	<p>Select the FX Bay (not the FX Parameter Bay!) then right-click on the FX. Choose FX parameters from the menu, then from the FX Parameters list choose an option (show in track controls, track envelope, parameter modulation or learn) from the sub-menu, then select the required parameter from the list.</p>

20 Using REAPER with Video

With the introduction of version 5.0, REAPER's video capabilities have been considerably enhanced and expanded. In overview, you can:

- ◆ Carry out simple editing tasks like deleting, moving or copying parts of a video.
- ◆ Edit an existing video soundtrack.
- ◆ Add new sound to a video.
- ◆ Add various visual effects to a video track, such as fading and lighting.
- ◆ Edit or blend the contents of several video files into one, optionally using effects such as crossfade.
- ◆ Use automation envelopes to manage your video effects.
- ◆ Render the output of your project into a new video file.

Throughout this chapter a basic understanding and knowledge of REAPER's audio, editing and project management features is assumed: only those aspects specific to video will be explained in detail. We'll start by looking at and working thru some practical examples, then towards the end of the chapter deal with the more technical aspects such as settings and preferences.

Later in this chapter we'll look at issues like video workflow, but first we'll look at how REAPER handles video.

20.1 Simple Video Editing

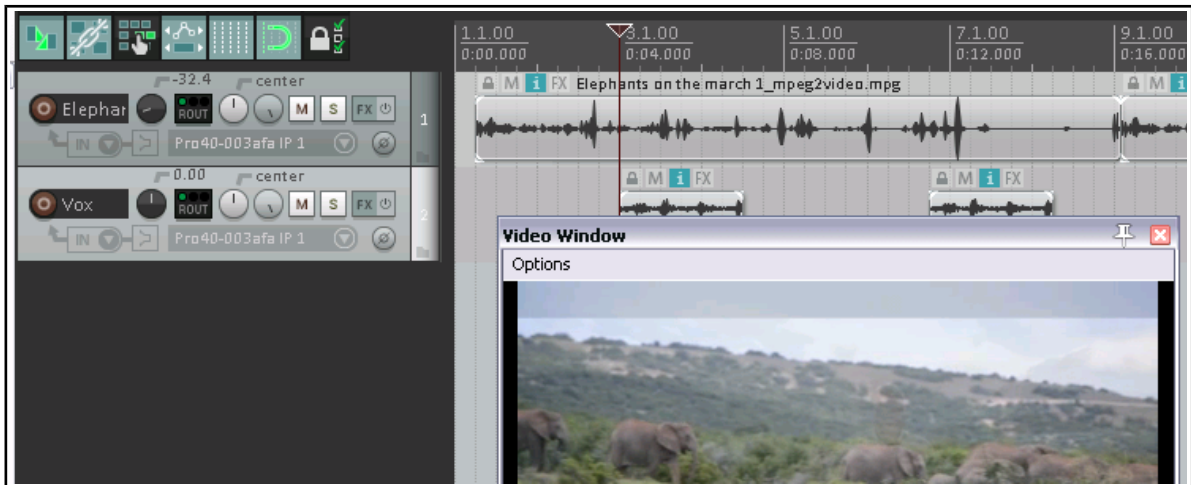

REAPER can be used to edit the soundtrack of your video files, such as .MOV, .WEBM, .AVI, .MPG, .VLC, .MP4 and .WMV files. These files are imported using the **Insert, Media File** command, or by simply dragging and dropping into REAPER's Arrange window.

In addition, you can use the **Track, Insert Track from Template** command to import data from a .EDL file. Use the **View, Video Window** command, **Ctrl Shift V**, to show the Video Window. This window is dockable. For Windows users, video playback is handled by Direct Show (but see 18.7): OS X uses Quick Time.

You can edit the original soundtrack, and/or add extra audio tracks and items to the existing soundtrack (as shown above).

The **Options** menu in the video window (shown right) offers a number of useful features:

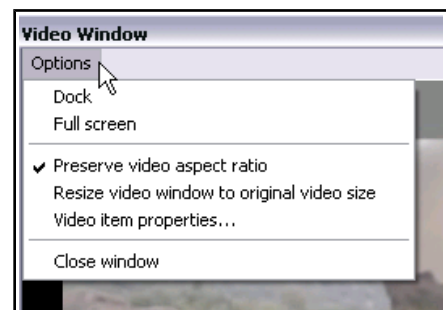

Dock: This option enables you to dock the video window. The same command will also undock an existing docked window. Docking is discussed throughout this user guide. In particular, simple docking is explained more fully in Chapter 2, and the use of multiple dockers is explored in Chapter 12.

Full screen: A toggle command used to expand the video window to cover the whole screen. In full screen mode, right click anywhere to display this menu.

Up and Running: A REAPER User Guide v 5.24

Preserve video aspect ratio: When enabled, this ensures that the height:width picture ratio is maintained no matter how the window is resized.

Resize video window to original video size: Needs no explanation!

Video item properties. This opens a window revealing the properties (length, video, audio, decoding format, etc.) of the video item.

Example 1

Download the sample projects from <http://www.cockos.com/~glazfolk/VideoExamples.zip>

To open them, you will need to have a utility program such as **AIZip** or **7 Zip**. The archive file contains two folders, **Wildlife** and **Zebras**. The video items are in MOV format. If they do not display in REAPER, you may need to install the VLC decoder. An easy way to do this is simply to install the free VLC media player (see also 18.7). In the sample clips, video quality has been compromised to keep the file and download size to a minimum.

In the first example we will start by performing some basic and simple editing tasks before getting a little more ambitious and adding some effects. *You should not attempt these exercises unless you have at least a basic understanding and experience of working within REAPER's arrange view environment.*

1. Open the project **Zebras.RPP**. You will find a video of about 45 seconds of zebras drinking at a water hole. Let's decide we want to shorten it a little. First, save it as **ZebrasDemo.RPP**.
2. Display the **Options** menu and make sure that **Ripple editing** is enabled for all tracks.
3. Click on the media item **Zebras.mov** to select it.
4. Within the arrange view window, select the time from approx 8 secs to 20 secs. Right click on the media item and choose **Cut selected area of item**. Press **Esc** to clear the time selection.
5. Now let's add a musical soundtrack. Turn the volume fader on the **Zebras** track all the way down.
6. Display either Windows Explorer or REAPER's media explorer and drag and from the **Zebras** folder drag and drop the file **morning.mp3** into your project as a new track. Shorten the audio track to make it the same length as the video. Save the file and play it.
7. If you wish, add a track to this project. On this track record a little spoken commentary, then use volume envelopes so that the voice will sit nicely on top of the music. Your project will look something like this:

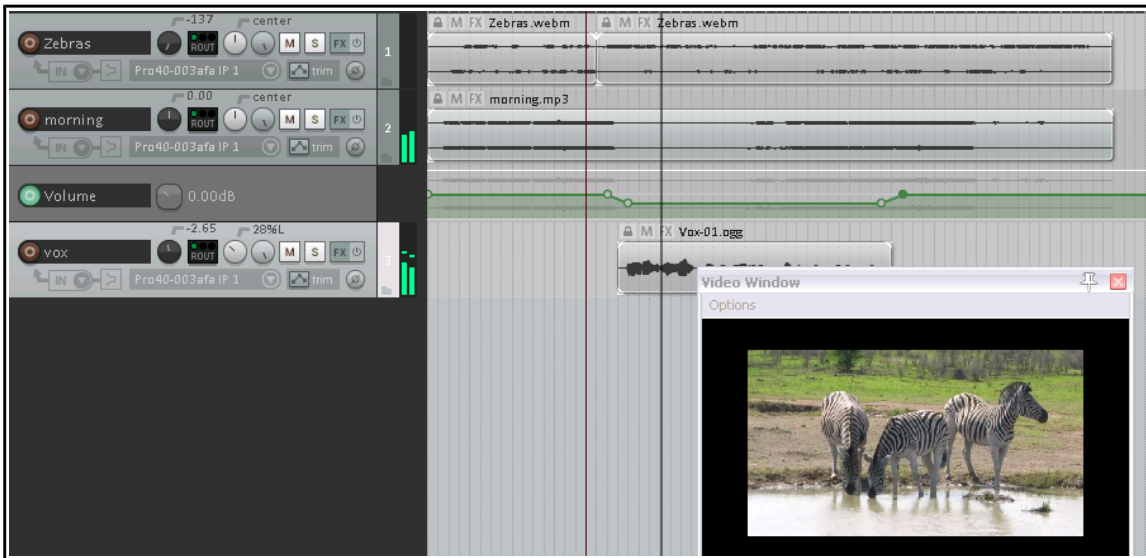

8. Save the file. Do not yet close it.

Now let's get a little more ambitious and add a video effect or two.

REAPER's video effects can be inserted into track or item take FX chains. They are flexible and powerful, but they do take some time and effort to get to grips with and to master. Some of them do include parameter control rotaries, but sometimes to get the best results you will need to be a little more adventurous. We'll dig deeper into explanations later in this chapter, but for now let's just explore some of the simpler options.

20.2 Video Effects

Example 1 (Continued)

9. Click on the **FX** button for the video track **Zebbras**. When the **Add FX** window is displayed, make sure that **All Plugins** is selected in the left pane. In the right pane click on **Video processor** then **OK**. Instead of a window with a standard familiar plug-in interface you will see something quite different. Currently no effect has yet been loaded.

10. Let's add a title. From the presets drop down list choose **Title overlay**. This might look a bit strange (see right).

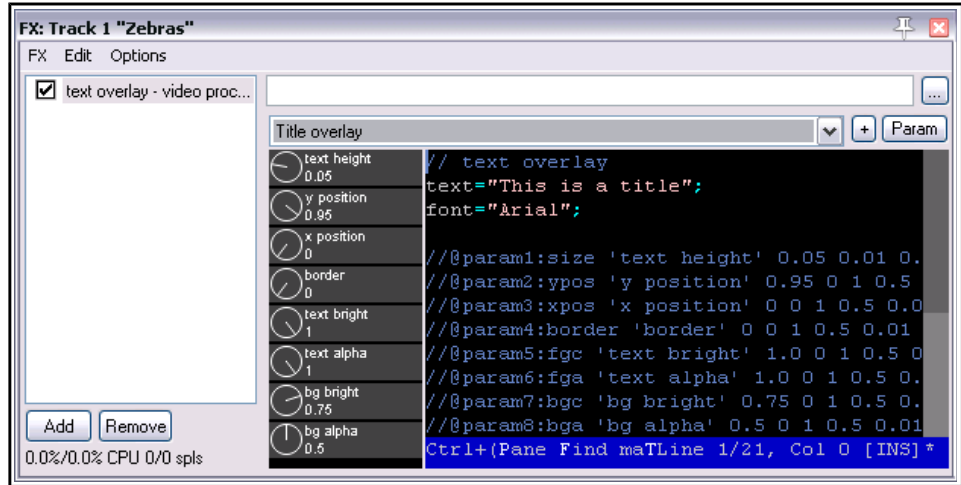

11. The first black column displays the parameter controls. These determine the size, appearance and position of the text.

12. The second column contains the actual EEL code used to create the effect. Notice that your video window currently displays the text **This is a title**. You should be able to see where this is also written in the FX window pane. Click in this pane and edit this line to read **Text="Zebbras"**; (edit only the text between the quote marks, nothing else), then press **Ctrl S** to save. The text in your video window changes.

13. Lets create some effects. Click first on this FX's **text height** parameter control button, then on the **Param** button (top right), then **Show track envelope**. Add points and adjust this envelope as shown here.

14. With your mouse adjust the **y position** knob to **0.07**. Play the video. The text will now be positioned higher up, starting very small and growing larger.

15. Let's suppose we only want to display the title for 10 seconds or so. This can be achieved by adding a bypass envelope.

16. Click on the automation button for the Zebbras video track (labelled "trim"). Under the heading **text overlay** select **Bypass**. Close the window: a bypass envelope will be displayed just beneath the track.

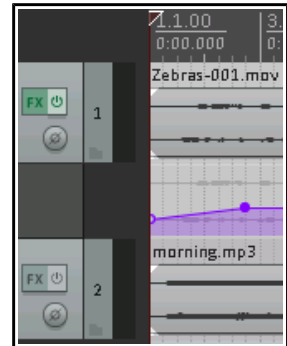

17. At or around the 10 second mark, add a point to this envelope and drag that point up, as shown below:

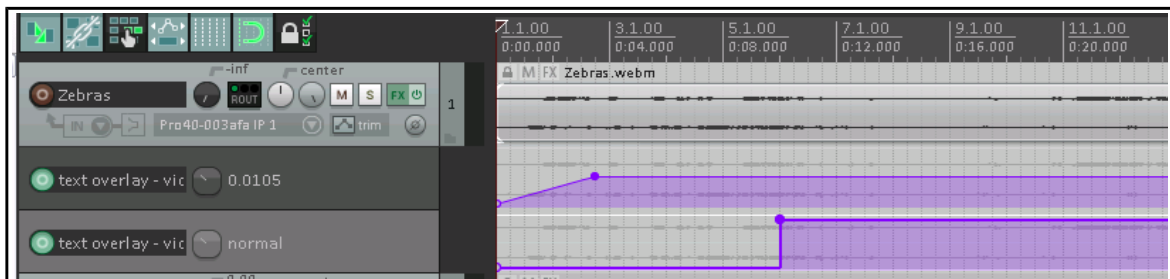

18. Save the file and play the video.

19. Now let's add a visual effect. In the FX chain for the Zebbras video track, add another instance of the **video processor**.

20. Into this effect load the preset **Horizontal wipe**. This preset includes one parameter control, labelled **wipe pos**.
21. Save the file and play it. Notice you can now only see half of the picture in the video window: the other half is blackened out!
22. We can fix this with an automation envelope. Add and envelope for this track for the parameter **wipe pos** on the effect horizontal wipe.
23. Adjust this envelope as shown below: you do not need to be exact in positioning the points.

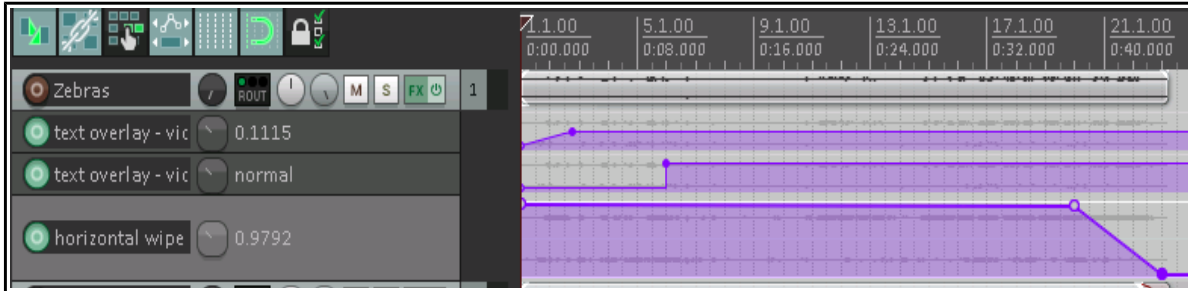

24. Save the file and play the video. The picture will now scroll out from the right at the end of the video. In the next example we will be a little more ambitious with our use of effects.

Note 1: When you modify and the code of a video effect, you are only changing it for that single instance, you are not changing the default. If you make a mistake or get confused, simply remove the plug-in from the FX chain, reinsert it and start again.

Note 2: Pressing **F1** from within a preset code window will open a help window which includes a list of parameters used by that preset,.

20.3 Working with Multiple Video Tracks

There is one important fact that you will need to get your head around before you start working on projects with more than one video track. *Unlike pure audio projects, when you are working with multiple video tracks the track order is significant.*

REAPER processes video tracks and items differently from the way in which it processes audio tracks and items. By default, REAPER will audibly process all audio tracks and items. With video, however, the situation is different, not least because you may have several video tracks all competing for the one video window. The *default* position is that where multiple video tracks are present, during playback only the item(s) on one of them will be displayed in the video window. Which one this is will depend on which is assigned the highest priority.

The following summary indicates how priority is allocated. However, it is important to be assured (as you will see in the examples later in this section) that by using transition effects and automation envelopes you can override the default behavior and determine which and/or how many of your items are displayed at any one time during playback.

- ◆ Video is processed from bottom to top, so that a lower numbered track will override a higher numbered track. For example, if track 1 and track 2 both contain video items, then without the use of envelopes and/or effects only the video contents of track 1 will be displayed in the video window during playback. The master track is processed last.
- ◆ A similar hierarchy exists on tracks with more than one video item and where free item positioning is used. That is, by default the contents of only the bottommost item will be displayed in the video window.
- ◆ Where video FX are used, video FX on the track process the output of the video FX on individual items.

There is an option on the Video page of your Project Settings which allows you to reverse the video processing hierarchy if you wish, so that video will be processed instead from top to bottom.

Working with video files can be a resource hungry activity, especially on older computers. If you are encountering performance difficulties during playback and/or editing, you may need to make tweaks to your video preferences options which can improve performance. These are explained at the end of this chapter.

Video effects can be inserted in any of three places – in the video item itself, in the video track, or in a separate video effects track. Depending on where you place them, the outcome can vary. If necessary, be patient, and be

prepared to learn by exploring!

This next example uses a project file with three video tracks. If you have downloaded and unzipped the sample files included in **VideoExamples.7z** you will find the folder **Wildlife** which includes two projects, **Wildlife1** and **Wildlife2**. Wildlife1 will be used for the practical exercises. Wildlife2 shows you how the project will look when it has been completed. The Wildlife2 folder also includes a further project with more examples (Wildlife3), but we'll come to that shortly.

Example 2

First, we will look at a project with some simple edits and video effects added. After that, we can discover how this was done. Open the file **Wildlife2** and play the video from the beginning. Notice in particular that:

- ◆ If you check the video page of your project settings (**Alt Enter**) you should see that **Items in lower numbered tracks replace higher**.
- ◆ There is an animated title.
- ◆ There are three video tracks, which have been edited so that at the beginning and end of the movie these are shown one at a time, in sequence, but in the middle they are faded in and out.
- ◆ An additional track, Track 1, contains no media items, only various video processing plug-ins.
- ◆ Further visual effects are used from time to time..
- ◆ Let's see how this was done, starting with track 1, Video FX.

The Track Edits

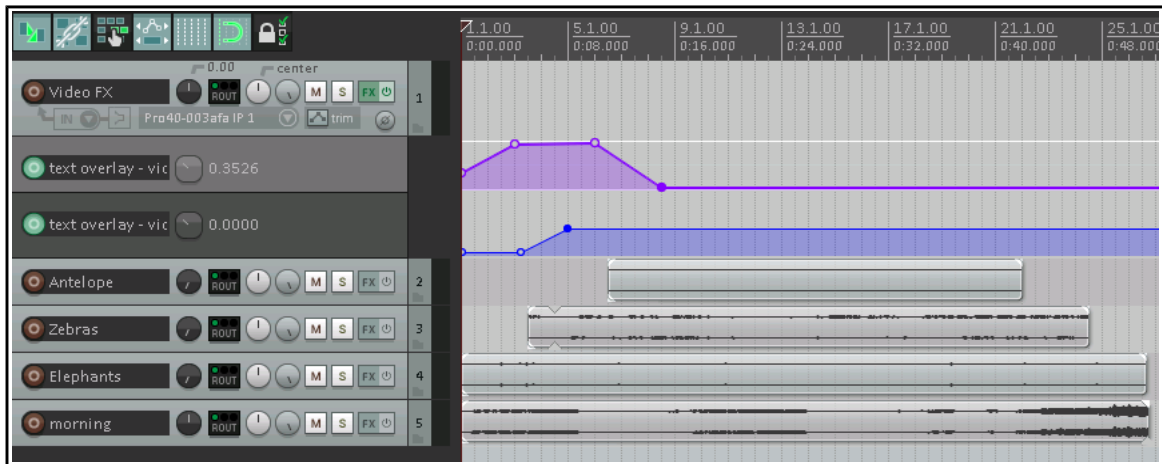

Simple slip editing has been performed on the video tracks. Because these are processed with lower track numbers having priority, when this is played you will initially see only the elephants (track 4), then only the zebras (track 3) then only the antelopes (track 2).

The Title

Position the play cursor at the very start of the video. A video processing effect instance has been added to this track's FX chain (track 1), and the preset **title overlay** selected.

The code has been edited with the text changed to **Morning in Africa**

Some parameter values have been changed from their defaults, notably **text height** (0.9), **y position** (1) and **text bright** (0.37). This last setting hides the text by making it the same color as its background.

Envelopes have been added (see above) to first fade up the text to make it visible (**text bright**), then scroll it across the screen to the center (**x pos**), then fade it out. A **bypass** envelope ensures that the title is removed altogether at or around the 13 second mark.

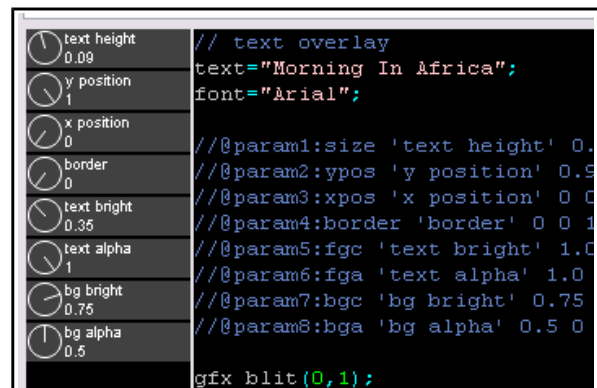

Tips: To help you understand the purpose of the various parameters, at any time you can click in the window containing the preset code and press **F1** to obtain further information (see right).

If you wish, you can edit these parameter values directly in the code. We will do this with the next example.

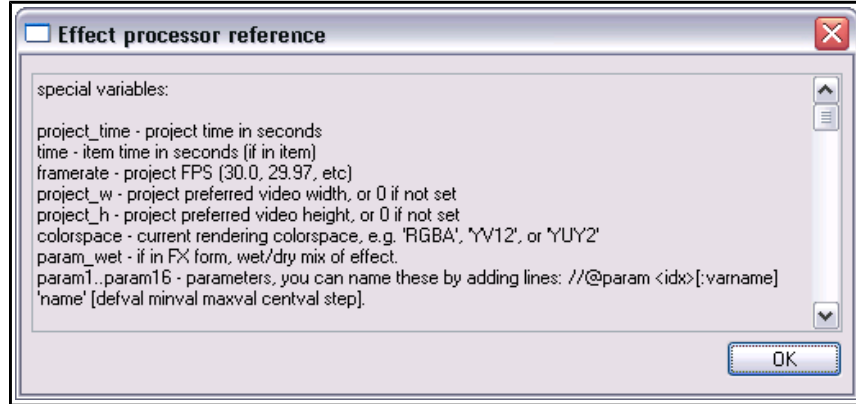

The Crossfade Effect

A second video processor instance has been added (above the text overlay) to Track 1, using the **Crossfade through inputs...** preset.

A **bypass** envelope is used to ensure that the crossfade is applied only during the period of approximately 20 seconds in the middle of the movie.

The speed of the crossfade is determined by the multiplier used to set value of the parameter **project_time**. The higher this value, the faster the rate of crossfade. In this example, this has been edited from its default value of 0.5 to 0.2 (see right)

```
// crossfade through other tracks
parm = project_time*0.1; // cycle speed
skip_inputs = 0;
skip_trailing_inputs = 0;
```

The Zoom Effect

An instance of the video processor plug-in has been added to the **Elephant** track and the preset **track opacity/zoom/pan** added. A zoom envelope is used to zoom this track out completely at the very end.

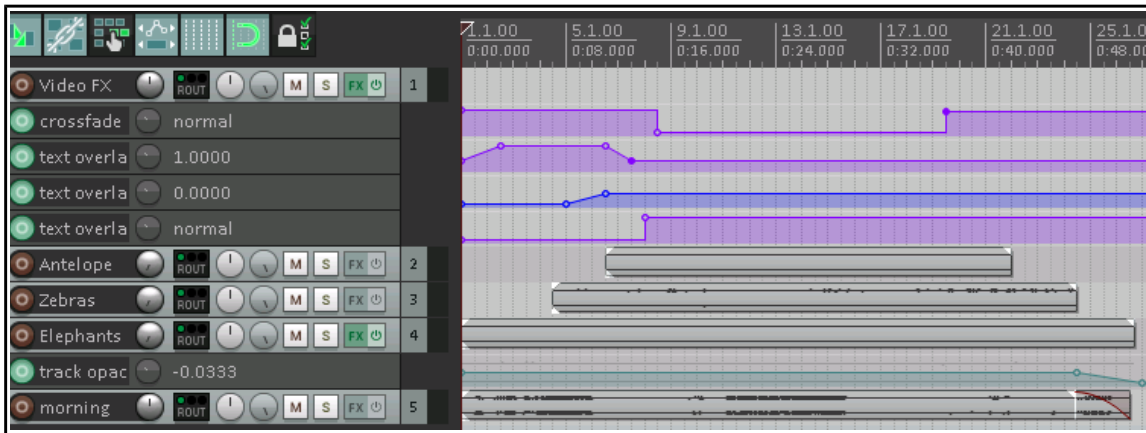

Note: If you develop a serious knowledge and understanding of scripting languages such as Lua or EEL then you have at your disposal an amazing scope for creating and using video effects in REAPER. However, as this example has demonstrated, even a very limited knowledge and understanding such as is required for this example places considerable power in your hands!

Try it yourself! Open the file **Wildlife1**, save it as **Wildlife1a** and have a go at reproducing these effects yourself. Any time you make edits to any code, remember to press **Ctrl S** to save. Don't yet be too ambitious: in the next example we'll explore a slightly more complicated example.

Example 3

This next example, **Wildlife3** uses the same source media files but includes some different effects. Shown here is part of the arrange view for this file. Play this video from the beginning, then we can have a look at what has been added.

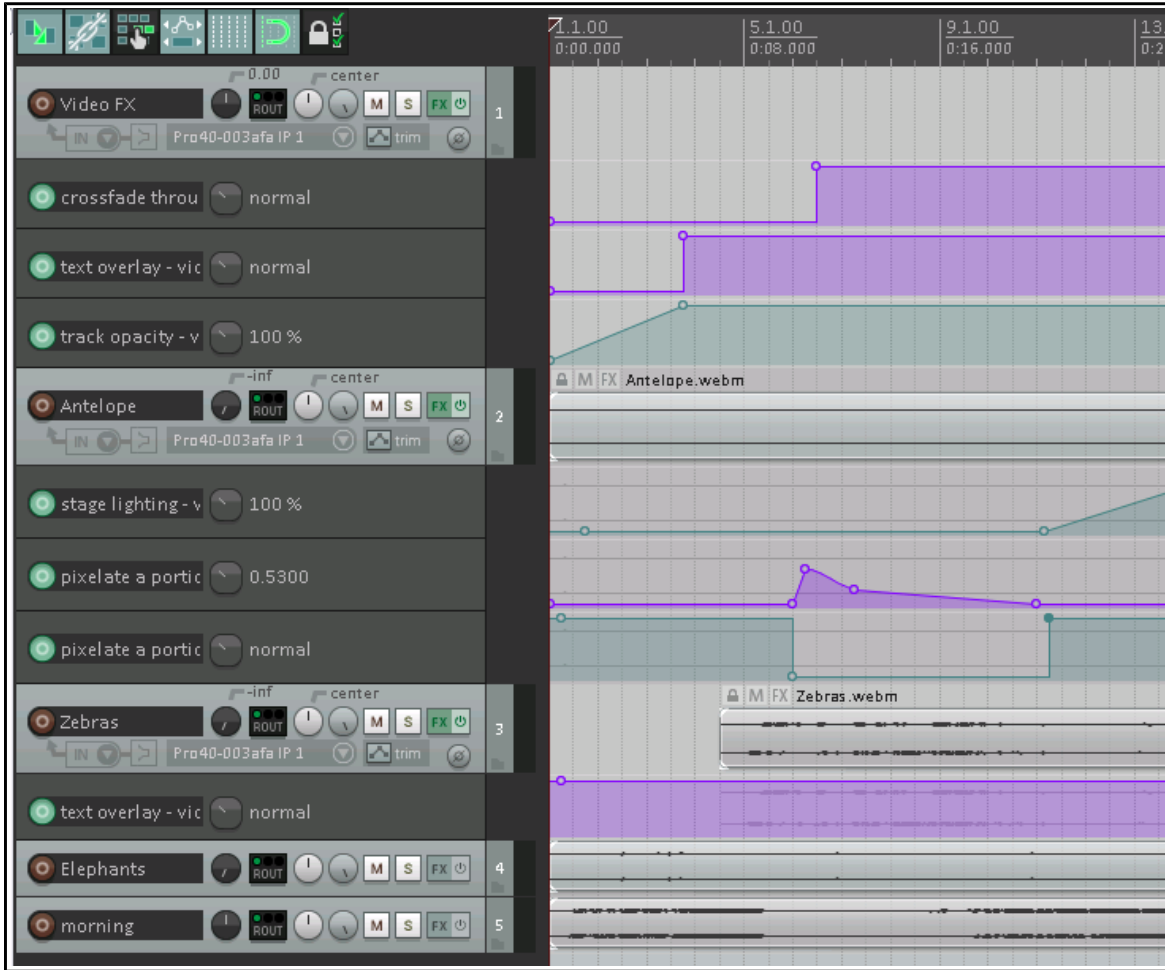

- ◆ The main title is now centered on the video window, is larger, and fades up at the beginning before disappearing. It reappears at the end and is faded down.
- ◆ There are more effects on the antelopes. They return at about the 10 second mark badly pixelated, then gradually ease into a clean image before the lighting effect is applied.
- ◆ The zebras have their own track title displayed, Time for a drink. This is displayed for a few seconds near the end of the video. Let's see how this was ALL done.

The Main Title: This should not need any further explanation.

The Antelope Stage Lighting Effect: A stage lighting effect has been added to the Antelope video track. Conservative values have been applied to the parameters to ensure that the effect is fairly subtle.

The Zebra Pixel Effect: An instance of the video processor has been added to the Zebra track FX chain, and the preset **pixelate a portion of the image** has been added. This preset comes with five parameter controls (knobs), any or all of which can be tweaked and/or automated.

Together, the first four determine the positioning (horizontal and vertical) and size (width and height) of the area covered by, the pixelated part of the screen. Experiment with these if you like. The fifth control determines the size of each pixel: this is what we are going to look at now.

A **pixelsize** and a **bypass** envelope have both been added for this plug-in. The bypass envelope ensures that the pixel effect is only displayed for the few seconds that it requires. The **pixelsize** starts at zero, rises sharply to about 50%, then gradually decreases again to zero.

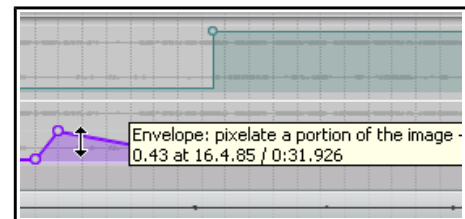

20.4 Video Processor Parameter Controls

The video processor plug-in includes the standard features of REAPER's audio plug-ins, explained in Chapter 6 of this User Guide. For example, the + button can be used to save and load your own **presets**.

From a track's FX chain, click first on any of the plug-in's rotary parameter controls then on the plug-in's **Param** button (right) to **add a parameter control to the TCP, add a track envelope, use parameter modulation** or use **the learn function** to assign the control to a controller. From an item's FX chain, you can add an automation envelope or access the learn function.

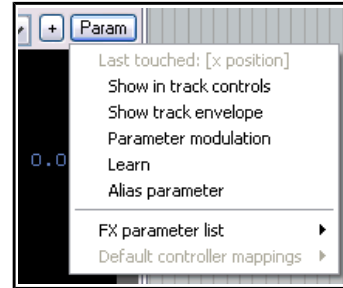

20.5 Video Effects Presets (Examples)

The number and variety of presets available for use with REAPER's video processor plug-in is being constantly improved and updated. At time of writing, the following presets are available:

Track opacity/zoom/pan	Horizontal wipe	Matrix of recent frames	Show motion (subtract last frame)
Item fades affect video	Faded top	Stage lighting	Simple source chroma-key
De-interlace	Matrix crossfade	Title overlay	Cheap brightness/contrast
2 x 2 input matrix	Crossfade thru inputs	Pixelate	
Vignette	Image overlay	YUV multiplier/desaturation	

Here are some examples of some of these effects in use. Over time, it can be expected that more effects will also be downloadable from the REAPER stash. It would not be practical to attempt to document all of these in detail here. The best way to learn is by doing! Play around with some of these effects on your sample project files and before you know it you'll be flying high!

Video Preset Examples

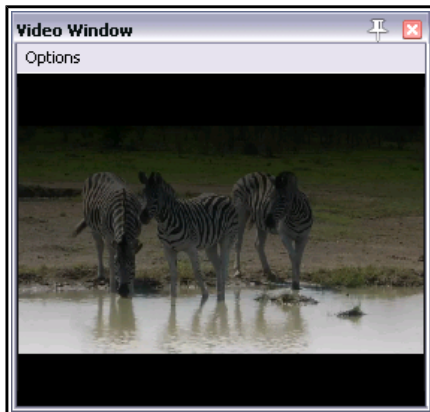

Faded Top

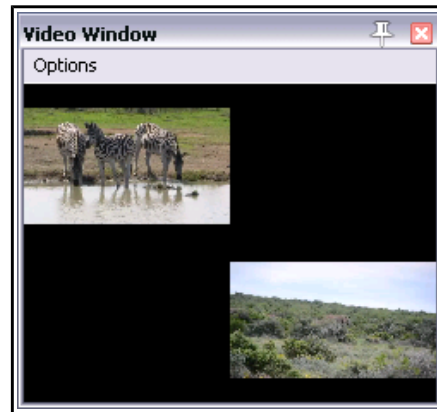

2x2 Input Matrix

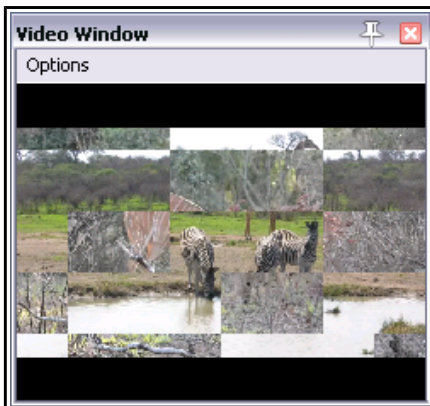

Matrix Crossfade

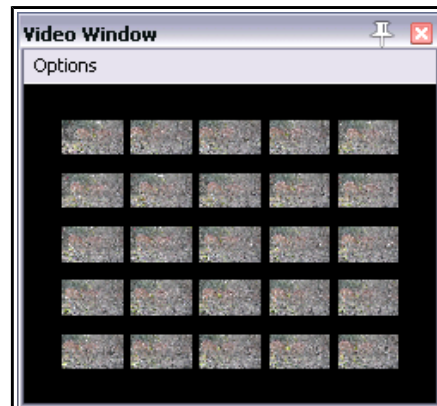

Matrix of Recent Frames

Video Preset Examples

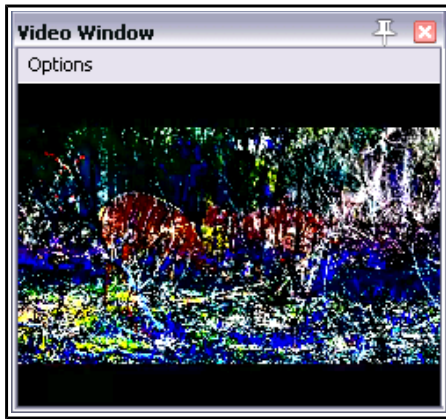

Show Motion

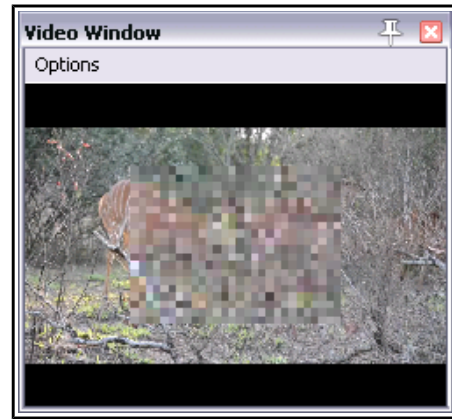

Pixelate

20.6 Understanding Video Formats

Newcomers to video often find the whole topic bewildering. This section aims to guide you thru some basic concepts, so that you can at least confidently get started. It is not comprehensive and by no means covers everything that you should eventually need to know.

Video files hold video and other data that exhibits a number of *attributes* such as frame rate, pixel dimensions and audio channels. Different *formats* can be used for capturing, saving, editing and distribution of this data. Different formats are characterised by the whichever *video container* and *codec* they use.

Video signal attributes

As with most things audio and video, the higher the numbers the better the quality and the larger the resulting file size! In particular, video characteristics include:

- ◆ **Frame size:** the video frame's dimensions, measured in pixels, typically within the range 160 (width) by 120 (height) to 1920 by 1080 (Full HD).
- ◆ **Frame rate:** the speed with which each frame is first captured then played back. Each frame holds a still image. The human eye starts to see motion (albeit "jerky") at 8 frames per second (fps). The motion will start to appear smooth at rates of 24 fps and above. The U.S. standard frame rate for 720 HD (1280 by 720 pixels) is 59.94 fps, often rounded up to 60 fps
- ◆ **Aspect ratio:** the ratio of width to height. This can be expressed either as whole numbers, e.g. 16 by 9, or as a decimal ratio, e.g. 1.78:1. 16 by 9 is the ratio used by widescreen TV.
- ◆ **Bit rate:** the rate at which data is transferred, for example, from the file to the screen. Bit rate is usually measured in megabits per second (mps). By way of example, HD Blu-ray video typically uses a bit rate of 20 mbps, standard DVD quality is around 6 mbps. HD mobile phone, on the other hand uses rates of 2500 (HD) or 5000 (Full HD) *kilobits* per second (kbps).
- ◆ **Audio sample rate:** the number of samples per second used to digitize recorded sound. This is discussed in Chapter 2 and Chapter 3.

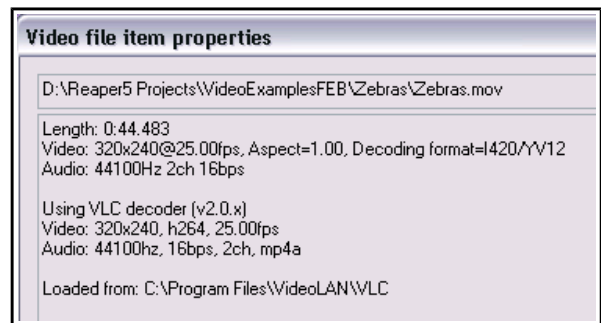

Container files

Container files are files that contain video (and other related) data. You are probably at least vaguely familiar with commonly used container extensions such as .MOV, and.AVI. Different containers provide different degrees of support for (for examples) different video and audio compression formats, subtitles, and so on. For example, several container formats support multiple audio streams, others support only one. In fact, you can learn very

little about a video file from its container type alone. To do that, right-click over the video item within REAPER and choose **Source properties...** from the context menu. An example is shown above.

When rendering video in REAPER (see Chapter 21) available formats are AVI, QT/MOV/MP4, MKV and WEBM.

Codecs

If the container format provides a container for holding a file's data, then the codec (coder/decoder) is the method by which that data is actually encoded. The very large number of codecs available makes this whole topic something of a minefield. Important characteristics of codecs include their video quality, performance factors (such as compression/decompression speed, supported profiles, options, supported resolution, and so on). Some codecs are available free of charge, others you have to pay for. Because raw video files are so large, file size compression is one of the most important aspect of video codecs. Indeed, most consumer standard recording equipment captures video in the first place in compressed rather than raw video format.

When rendering in REAPER, your choice of codec will largely depend on which container format is selected.

20.7 REAPER Video Processing Tips

1. For Windows users, if a video file won't play in REAPER, the chances are that you do not have a codec (coder/decoder) required for that video format. Codecs are freely available on the internet. Download and install the VLC decoder from <http://download.videolan.org/pub/videolan/vlc/2.2.1/> Choose win32 or win 64 (depending on your system), then download and install the required .exe file. This will also install the codecs required for AVI, MKV, MP4, WMV, MPEG-1, MPEG-2, DIVX and many other video formats. Moreover, video playback will now be handled by VLC rather than Direct Show.

2. The Media, Video/Rex/Misc page of your Preferences includes an option for you to specify your own video decoder priorities. If you get into trouble here, there is an option to **Reset to defaults**.

20.8 REAPER Video Settings and Preferences

Pressing **Alt Enter** displays the project settings dialog. Select the **Video** tab.

You can select a **frame rate** from the drop down list, or type in your own value.

Optionally, you may enter a **preferred video size** if you wish. If this is left blank, the video will try to size to the active media being played. If your project has videos all recorded at the same dimensions, setting this is unnecessary. If you have various videos at different resolutions, it can be advantageous to specify a size here. If you provide only a width or a height, it will adjust the other value to put things at a default 16:9 ratio.

Video item visibility determines the order in which video items are processed. **Items in lower numbered tracks replace higher** is consistent with the approach taken by most video editing programs, but you can select **Items in higher numbered tracks replace lower** if you wish.

Your options for **video colorspace** are auto, 1420/YV12, YUY2 or RGB. Both YUY2 and 1420/YV12 store data more efficiently than RGB and offer an almost lossless form of file compression (but see comments below).

Video colorspace options are **Auto**, **1420/YV12**, **YUY2** or **RGB**. **Auto** will ensure that whatever colorspace the media natively decodes will be used. Usually this is YV12.

YV12 is the output mode used by most modern codecs (such as h264, or MPEG-4, or MPEG-2, or WEBM), and is usually the fastest because it can avoid colorspace conversions.

YUY2 is similar to YV12 but is less-often used, and offers a little bit better color resolution (due to using less subsampling for luminance and chroma). Converting from YV12 to YUY2 is relatively inexpensive.

RGBA is a completely different mode that matches the pixels on your screen. It is expensive to convert from YV12 or YUY2 to RGBA, and processing video frames in RGBA is also slower. Using RGBA also causes the chromakeyed blit functions (such as the chroma-key preset) to use a different algorithm, so it will look different. In fact, things will generally look slightly different in RGBA mode.

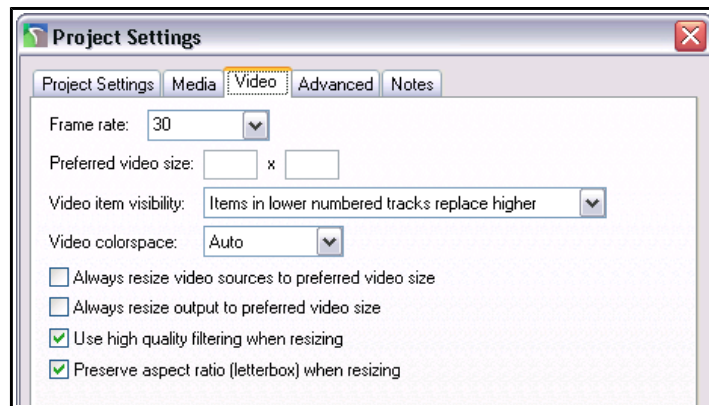

Other settings are toggles for the options **Always resize video sources to preferred video size**, **Always resize output to preferred video size**, **Use high quality filtering when resizing**, and **Preserve aspect ratio (letterbox) when resizing**.

The option to **Always resize video to preferred video size**, if selected, will always resize the video if necessary prior to any processing. This can simplify use of certain FX, but also can be less efficient (since other FX can handle the resize natively as part of their own processing).

The option to **Always resize output to preferred video size**, if selected, forces a resize if necessary at the output stage (meaning processing may happen at some other resolution, but at the end it is resized to the specified size for display). When rendering to a file, this option is effectively selected, with the preferred width/height set to the rendering width/height output.

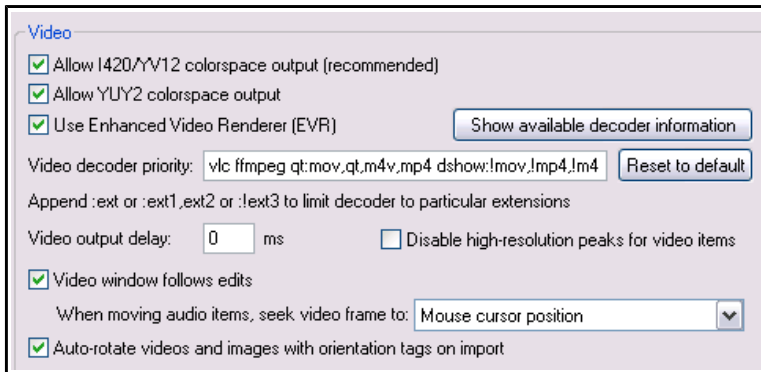

Shown left is the video section of the **Media, Video/Rex/Misc** preferences screen.

Enabling **1420/YV12** and **YUY2** colorspace output allows for better video performance but can be disabled if you are encountering problems with playback. Using **EVT** can improve video display quality on Vista and Windows 7 systems.

You can if you wish edit the **Video decoder priority list** to change the order in which priority is allocated. By

default, VLC format is assigned the highest priority.

The options to specify **Video output delay** can be used if necessary to improve playback synchronization. This can be a small positive or negative amount. There is also an option to disable high-resolution peaks. Enabling the option **Video window follows edits** ensures that the video window will synch to the seek point when audio items are moved or resized.

You can further choose your preferred behavior when audio items are moved, so that the video window displays content at the mouse cursor position, the start of the audio item, or a snap offset of the audio item.

The **Video file item properties** dialog (accessed by choosing **Source properties** from the item context menu) includes options to **Ignore audio** and for handling **Hi-res peaks**.



There is also an option to **Copy audio settings to all video sources**.

In addition, the **File, Render** command can be used to export video from REAPER - see Chapter 21.

At wiki.cockos.com/wiki/index.php/Video_Support you can find more tips and information about working with video files in REAPER.

20.9 Video Workflow Tips

If you are new to video editing, you might find the following tips helpful. They make reference to many of REAPER's tools and features (such as media explorer, screensets, track manager, markers and regions) that are explained elsewhere in this user guide.

Of course, these tips are general. Whilst they are intended to help you, you will most likely also have considerations specific to your own needs and workflow that might not be mentioned here, or that might make aspects of this model less suitable for you.

1. Video files require large amounts of disk space. However, even if you are intending to distribute your work over the internet, perhaps via YouTube, you should record and edit your material (video and audio) in high quality, then use lossless codecs to convert your files for distribution. A number of freeware programs are available for this, such as MediaCoder, Quick Media Converter and Super Video Converter.
2. Before you start editing, organize all your material. This might be scattered across various SD cards, hard disks, USB sticks, or whatever.

Up and Running: A REAPER User Guide v 5.24

Copy all your source materials into one place on the hard disk of the computer on which you use REAPER. Create a folder for the project, and various sub-folders for your media, such as videos, audio music, audio spoken, and so on. If necessary rename your various source files to make them more easily identifiable and so as to present them in a logical order. Make sure that after *every* editing session you back this folder up to at least two different destinations.

3. Create your project file in REAPER. Check your project settings, especially the video settings. Specify your required timeline format: remember that available formats include **Hours:minutes:Seconds:Frames** and **Absolute Frames**. Set up a windows screenset suitable for video editing, remembering, for example, that the video window is dockable, that media explorer is available to you for managing and accessing your source materials, and that track manager is available for managing your tracks.
4. Import your video files into your project. Any video takes that run in parallel to each other (i.e. at the same time) will need to be placed on separate tracks. Items that are sequential may be placed on a single track.
5. Use markers and regions to help manage the media items in your project. Make such edits as you need to your video items.
6. If you need to replace the soundtrack of a video item with a separate audio item, display the video item's **Item Properties**, then click on the **Properties** button and enable the checkbox **Ignore audio**. The replacement audio item should be placed on a separate track.
7. Add transition effects and text titles.
8. Edit existing audio and/or add any new audio material that may be required.
9. When you are ready, render your project to a single file.

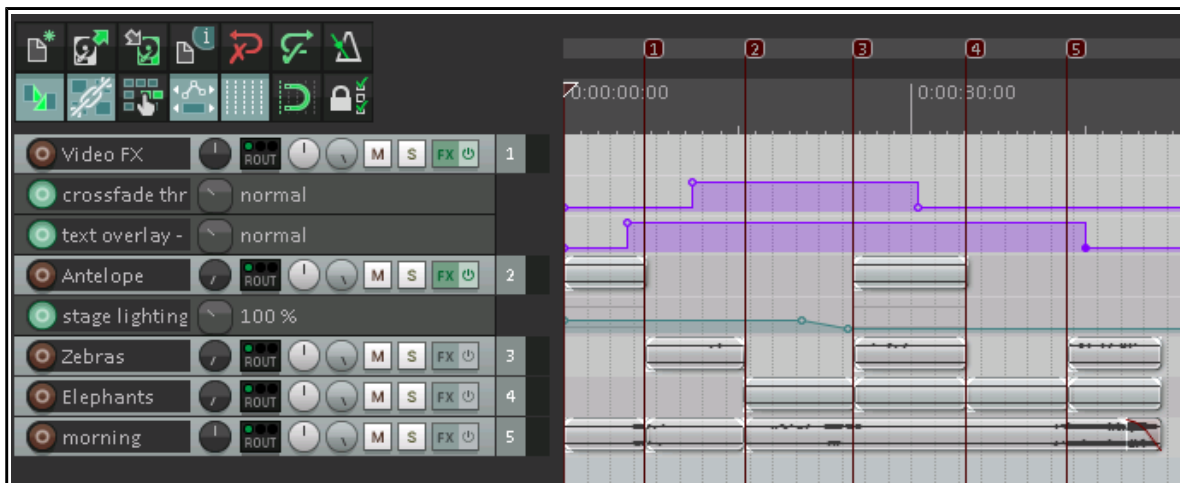

A simple example of such a project is shown above. This is included as **Wildlife2a** with your sample files.

20.10 Making a Home Music Video on a Budget

Here is an overview of one way that this process could be applied to making your own music video on a budget.

1. Work out your exact musical arrangement.
2. Video record the band playing the song to this arrangement. Make sure you include the sound in the recording. Using more than one camera will potentially make for a more interesting final product, because of the opportunities it offers to cut, crossfade, etc.
3. Create a new project file and import your video items, each to a separate track. Import also any additional video items (e.g. not of the band playing) that you wish to use. If you have more than one item, turn the volume on all but one track all the way down.
4. Using the video sound track as a guide track, overdub record every part (vocals and instruments) in the studio, as you would for a non-video project. Add any other audio material that you need.
5. Edit and mix the audio material in your usual way. Edit your video tracks as required.
6. That's it! Save and render.

21 Exporting Files, Mixing Down and Rendering

21.1 Introduction

There are three main tools available to you for taking your finished projects or tracks out of REAPER, for example for final distribution or for further processing elsewhere. These are:

- ◆ **Consolidate Tracks:** this outputs tracks pre-processing (ignoring for example track FX and panning). Use this, for example, if you are supplying files to be mixed/mastered by someone else.
- ◆ **Render to File:** this outputs your material post-processing (including for example all FX and panning). Use this to produce a final mix of your songs ready for distribution.
- ◆ **Batch File/Item Converter:** this takes a collection of files at any stage in your project and converts them en masse to another format – for example, to convert audio to MP3 for web distribution, or SFX for games to 22 kHz mono.

Note: Some of the arrange view illustrations used in this chapter use the REAPER 4 default theme and color scheme. The information and instructions, however, are still accurate and correct for REAPER 5.

21.2 Batch File Conversion

You might have several tracks to convert to another format, e.g. from .WAV to .MP3.

This can be done in one pass, using REAPER's batch file converter, accessed by choosing **File, Batch file/item converter** from the main menu. This dialog box (right) will be displayed. Follow this sequence:

1. In Arrange view, select the items to be converted then click on **Add**, then **Add selected media items**, or
2. Click on **Add...**, then **Add files...** : select files and click on **Open**.
3. To remove any file from the selection, click on its name in the File Converter window, then click on the **Remove** button. To clear the entire selection, use the **Clear** button.
4. Specify output directory (or select **Use source file directory**). Leave the **File name** blank for the default name (shown in the Output column), or enter your own. You can include text and/or any of the many available wild cards. The above example uses track number and track name. See note about wild cards below.
5. Leave the **sample rate** and **channels** at source to use the same values for your output files as are used by your input files. Otherwise, you may make what changes you like – e.g. from stereo to mono, or from 88.2 kHz to 44.1 kHz.
6. Optionally, you can select **Use FX**. If you select this option, you should also click on the **FX chain...** button to specify your required effect(s) – for example, perhaps a limiter. When Use FX is enabled, you may also specify an FX tail length in ms.
7. Select your required **output format** (e.g. MP3, OGG, FLAC) and any parameters associated with that format. Depending on the format, you might have the options for dithering and/or noise shaping.
8. To convert the files, after making your selection click on the **Convert All** button. This opens the **File Conversion** window (see above).

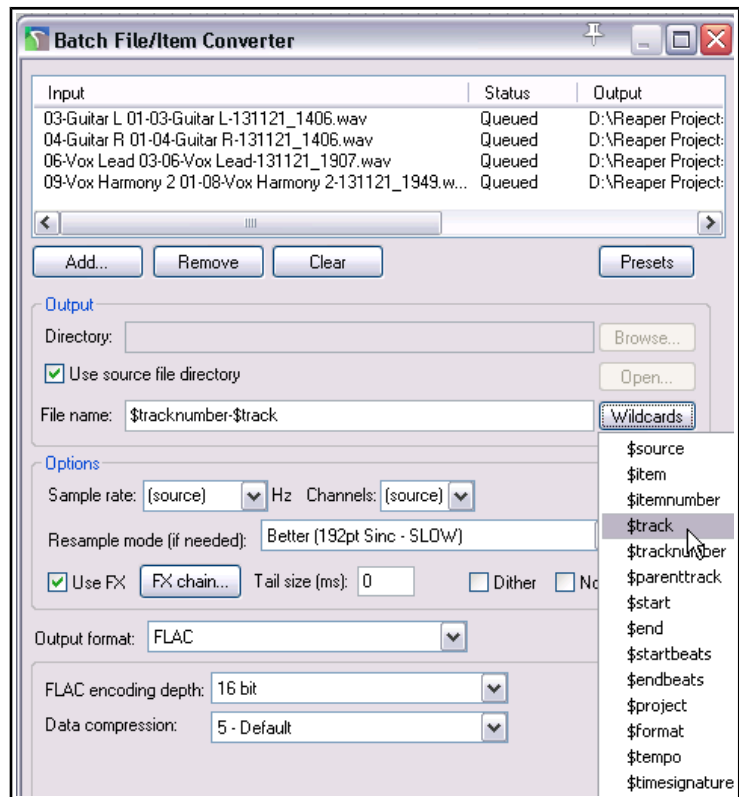

Up and Running: A REAPER User Guide v 5.24

Note on Wildcards: Using wildcards causes individual information included in the name of each rendered file. For example, including \$project in the filename will cause the actual project file name to be included in the name of the rendered file. Including the backslash character between wildcards causes a sub directory to be created. For example, when rendering individual tracks, naming your output files \$project\\$track would cause a separate subdirectory to be created for the output of each track.

21.3 Consolidating and Exporting

You might be collaborating on a project with someone else, or with other people. Perhaps, for example, you want to send your project to a friend who will add some vocal harmonies to your song. What if that friend lives a long way away? You could send her your .RPP file together with all the media item files. But what if she doesn't use REAPER?

Perhaps she uses a different software program, or perhaps she doesn't have a DAW herself and will need to use a commercial studio for this purpose. In



this case, it should first be consolidated and exported. Take a look at the example above.

Here, the Vox track is made up of three items, each covering part of the total song. If we were to send the media files (six in all) to someone else, then it would be difficult for them to line the items up.

That's where consolidate and export helps. It creates a new set of audio files, just one file per track. Once these new files are inserted in another DAW, each starting at zero time, one per track, then everything will be in the right place for further mixing.

1. Depending on what you wish to consolidate, if necessary make any time selection and/or track selection.
2. From the main menu, choose **File, Consolidate/Export Tracks**.
3. Choose **Entire project** or **Time selection** or **Custom** selection, then **All** or **Selected tracks**.
4. Decide if you want to have **sample rate** and **number of channels** automatically determined, or whether to specify these yourself.
5. Select a **Resample Mode**.
6. Specify **consolidation** format and **bit depth** – WAV, AIFF, DDP, FLAC, MP3, OGG Vorbis, OGG Opus, Video LCF or WavPack. In the example shown, WAV has been selected.
7. Select your required specifications for your chosen format. For example, for WAV files you need to select a bit depth and specify whether you want to use BWF data, include markers and regions, and how to deal with MIDI data. If in doubt, speak to the person to whom you will be sending the consolidated files.
8. Specify your **Output directory** (where the files will be written to). Specify whether you wish to **update** your project with the newly consolidated files.
9. Specify a name for the new project file (or accept the default). Click on **Process**.

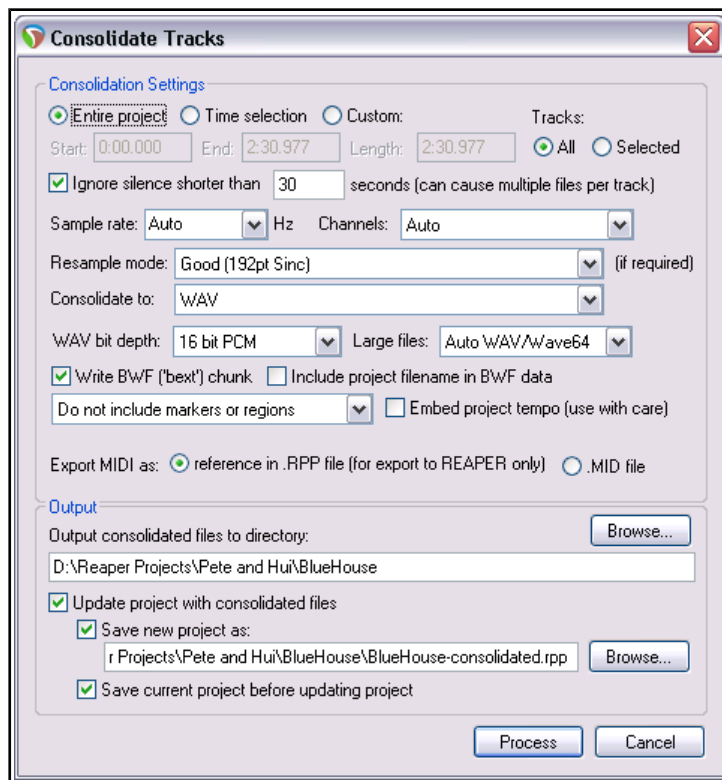

Note: Be careful how you use the option to **Embed project tempo**. It adds an ACID tempo tag to the audio file(s). This may be interpreted by any tempo aware application so that the audio is stretched or processed when you do not wish this to happen. Only enable this option if you are certain you want the tempo embedded.

21 - Exporting Files, Mixing Down and Rendering

Shown here is an example of a project after consolidation, with one media item per track. It is now a simple task to import these four media items into any DAW program, then overdub the vocal harmonies.



Note: To consolidate in MP3 format you will need to have the correct free Lame encoder file for your platform and REAPER version. For example, for Windows XP or Vista this is **lame_enc.dll**. For 64-bit Windows it will be either **libmp3lame.dll** or **lame_enc64.dll**. The file should be placed in your **C:\Program Files\REAPER** folder. It will take you only a few moments to use Google to find a suitable download location. Likewise, for output video rendering you will require an encoder such as **Ffmpeg.dll**. This goes in your REAPER Plugins folder.

When you consolidate media in this way your item settings and properties (e.g. take envelopes, take FX, item pitch adjustment) will be incorporated in the output files, but track based properties (e.g. track FX) will not be. To apply your track FX chain, track envelopes, etc. to your output media, you should instead use the **Render to File** dialog, selecting **Stems (selected tracks)** from the Render drop down list.

21.4 Rendering A Project

As you'll find out before you reach the end of this chapter, the **File, Render...** command has several diverse uses. One common one is for rendering a complete project down to a single stereo file.

Let's say that you have finished your recording, completed your edits, added all your FX and automation, arranged all your tracks and now you want to produce an end product for distribution.

If you're aiming for an audio CD, you will need one 16-bit stereo wave file for each song on the CD.

If you're distributing thru the web, then most likely you will want a series of stereo MP3 files. Whatever format you choose, each project will ultimately need to be rendered down to one file.

To do this, we use the **File, Render** command or the shortcut **Ctrl Alt R**. The dialog box (right) shows the various options. You must specify a directory and file name: if you wish, use the **Browse** button for either or both of these. Your other choices will depend on the ultimate destination of your material. A summary of **Render to File** dialog box options follows below.

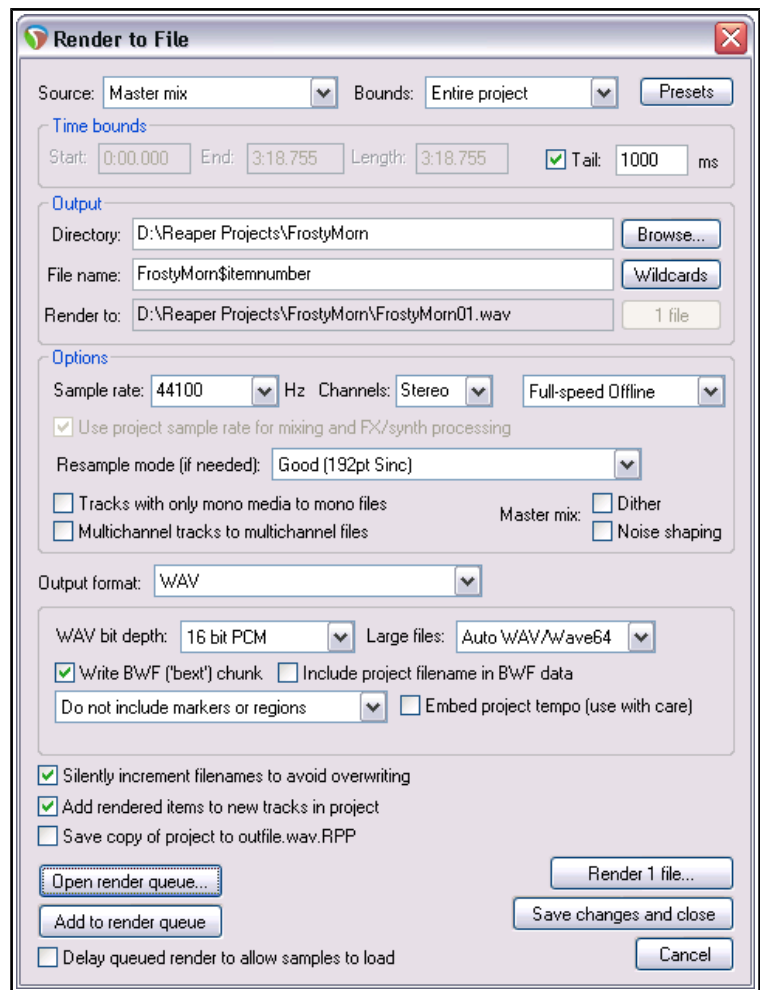

Up and Running: A REAPER User Guide v 5.24

Option	Explanation
Render	Choose master mix to mix all material to a single file, stems to render selected tracks to separate files, or both . Stem rendering is explained in Chapter 6. Other options are region render matrix (explained later in this chapter) or selected media items .
Presets button	Saves settings as a preset, or loads a previously saved preset. Preset settings can include Render bounds and output, Options and format, or All settings . Saved settings will automatically be added to the Presets menu.
Render Bounds	Select custom time range (enter in edit boxes), Entire project, Time selection (made in arrange view), Custom time range (enter start and end times in dialog) or Project regions (selected in Region/Marker Manager or Region Render Matrix). For Entire project , markers named =START and =END (if present) will be used to define start and end of project for rendering.
Directory and File Name	These are entered into the respective edit boxes. Any directory specified in your Preferences will be used by default. You can accept this default, or instead type in a directory of your choosing (relative to the project directory, or absolute), or use the Browse button. <i>See Chapter 22 .2.2 (General, Paths and Keyboards) for more about relative and absolute paths, and how to set them.</i> Use the Wildcards button to include in the file name information such as track name or number, region name, project file name, and/or date/time stamps. The render path and file name to be used will be displayed in the Render to box, just below the Directory and File name edit boxes.
Sample Rate	Select a value in the range 8000 to 192000, depending on output format and other factors. Some examples follow in the table after this one.
Channels	Choose mono, stereo or select a number for multichannel output.
On or Off-Line Speed	Full-speed (default) for fastest rendering. Others include 1 x offline, online, online (idle) and offline x 1 (idle).
Use project sample rate...	If enabled the project sample rate will be used for mixing and FX/synth processing. If in doubt, leave this enabled.
Resample mode	Various options allow trade off between speed and quality. Default is 192.
Use project rate	Enable this to automatically use project sample rate for mixing/processing.
Tracks with only mono media ...	Enabling this option ensures that mono channel rendering will automatically be applied to tracks where all media items are mono or with a mono Item Setting.
Multichannel tracks...	These can be rendered to multichannel files. An example follows shortly.
Dither, Noise Shaping	Not available with all output formats, commonly used when rendering 24 bit (or higher) audio material to 16-bit WAV format for audio CD. Creates a smoother transition to the lower sample rate in the rendering process.
Output format	Choose WAV, AIFF, audio CD image, DDP, FLAC, MP3, OGG Vorbis, OGG Opus, video (Ffmpeg/libav encoder), video (GIF), or WavPack lossless compression.
Format specific options	Other options will depend on the format. For example, for WAV or AIFF files, bit depth will need to be specified, for FLAC you must select FLAC encoding depth and data compression level, for MP3 bitrate mode (for example, variable or constant) and the actual bitrate, and so on. When rendering to WAV files, you may also specify whether markers, regions, both or neither should be embedded as cues in the output file(s). The option Include project filename in BWF description is also available for WAV format: it associates rendered files with the source project – see Chapter 12. For WAV files you have also the option to embed the project tempo.
Silently increment filenames...	Prevents you from accidentally overwriting an existing file: if an existing file name is used, an incremental number such as 001 will be added to the name.

21 - Exporting Files, Mixing Down and Rendering

Option	Explanation
Add rendered items to new tracks...	If enabled, this option causes your rendered file(s) to be added to the project as new tracks.
Save copy of project to outfile.wav.RPP	Tells REAPER to make a time and date stamped copy of your project file, preserving all settings exactly as they are at the time of rendering.
Open render queue Add to render queue	These options are used in batch rendering, which will be discussed shortly.
Render x files	Causes the project to be rendered to one or more files, depending on options.
Delay queued render to allow samples to load	Resolves problems that can be caused when samples (especially large samples) need to be loaded before rendering.
Save changes and close	Saves and closes the render settings without rendering any files.

Project Rendering Examples

Example	Specification
DVD Audio Soundtrack	Sample Rate: 48000 HZ, Channels: Stereo, Higher Quality Output format: WAV format, 24 bit
CD Audio	Sample Rate 44100 HZ, Channels: Stereo, Higher Quality Output format: WAV format, 16-bit
Apple Mac	AIFF Format. Preferred settings will vary with individual circumstances.
Web Site / Web Audio	Sample Rate 44100 HZ, Channels: Stereo, Higher Quality Output format: MP3 format Other options may vary as you trade off files size and download time against audio quality, but a typical selection might be CBR (Constant Bit Rate) 96 or 128, Joint Stereo, Quality High
Monkey's Audio	Use this format for lossless compression at 16 or 24 bit, sample rate as preferred.
Audio CD Image (Cue/Bin) format	Specifications as for CD Audio. This option can be used to burn your rendered output directly to CD, or to create an image file on your hard drive for use with other CD burning software. You can specify how markers or regions should be used to define tracks. This includes the option only to use markers whose name begins with "#", in which case these become track markers. Further information about how to do this can be found later in this chapter.
Multichannel Tracks	<p>We look at channel splitting and creating multichannel tracks in detail elsewhere in this User Guide, especially in Chapter 17. You might have such tracks that you wish to export in multichannel format, perhaps for use with another program. First select the tracks in the track control panel, then open the Render to file dialog box and include these options:</p> <p>Channels - Select the number of channels, e.g. 4 Select Render stems (selected tracks) to similarly named files. Select Render multichannel tracks to multichannel files. Optionally, Add items to new tracks in project when finished.</p>

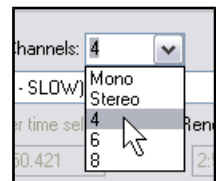

Shown here is a 4 channel track (Track 1) rendered in multichannel format (Track 2).

Tip: The Action List includes actions **File: Render project using the most recent render settings** and **File: Add project to render queue using most recent render settings**. These can be assigned to shortcut keys or a toolbar.

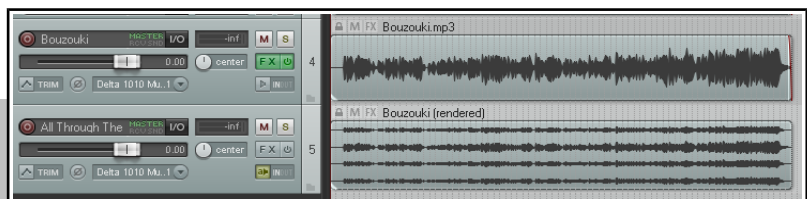

21.5 Rendering a Finished Song

When rendering a finished song your output format choices are likely to depend on whether your final destination is, for example, audio CD or the web. However, there are a few tips that you may wish to keep in mind which are equally applicable to both.

Your recording might have a few seconds of silence before the song starts. If you do not wish to include this period of silence in your rendered material, follow these steps before rendering:

1. Position the play cursor at the point where you wish the rendering to commence. Press **Shift M** to create a marker at this point. Name this marker **Start** (above right).
2. Position the play cursor at the point where you wish the rendering to stop. Press **Shift M** to create a marker at this point. Name this marker **End**.
3. With loop points linked to time selection, double click on the marker line (above the timeline) anywhere between the two markers. This selects the entire area between them.
4. From the REAPER menu, choose the **File, Render** command.
5. Select the required output format and other options as required, but be sure to include the option **Time selection** from the Render Bounds drop down list.. The settings shown at the start of section 18.4 would be suitable for producing a file for CD audio. Shown here are those that would be suitable for producing a .MP3 file. Notice that for MP3 some options (e.g. dither and noise shape) are not available.
6. Remember that you can use =START and =END markers within a project to define the start and end positions.
7. When you are ready, click the **Render 1 file ...** button in this dialog box to render your file.

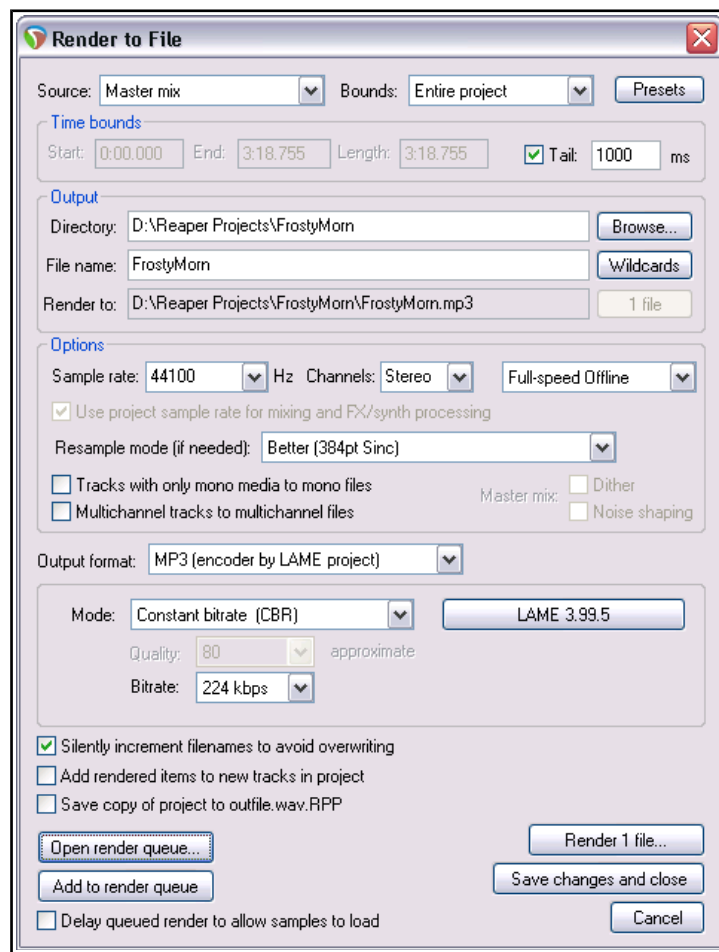
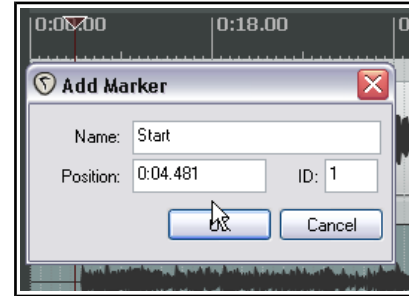

21.6 Batch Rendering

You might have a collection of songs (perhaps to go together on a CD) that you wish to render together when the project is finished. That way, you can go away while REAPER renders the whole set, and then come back later. Follow this procedure:

For Each Project to be Rendered:

1. Open the project and choose the **File, Render** command.
2. Choose your various settings and options, as explained in the previous sections. You will probably want to select the same folder (directory) for all of the projects that will be included in the batch to be rendered.
3. Do *not* click the Render1 File button. Instead, click the **Add to Render Queue** button. When you add a file to this queue it is saved as it is at that point in time. If you make any later changes to the file that you wish to include, you should remove the file from the queue, then add it back again.
4. The dialog box will be closed, and nothing appears to happen. Save and close the file.

21 - Exporting Files, Mixing Down and Rendering

To Render the Queued Batch of Projects:

When you render the files in the queue, each will be rendered to a separate file according to the settings and options that you made for each file individually when you set up the batch.

1. From the main REAPER menu, choose the **File, Show Render Queue** command.
2. This causes a dialog box (right) to be opened. All files in the render queue (in this example four) will be listed.

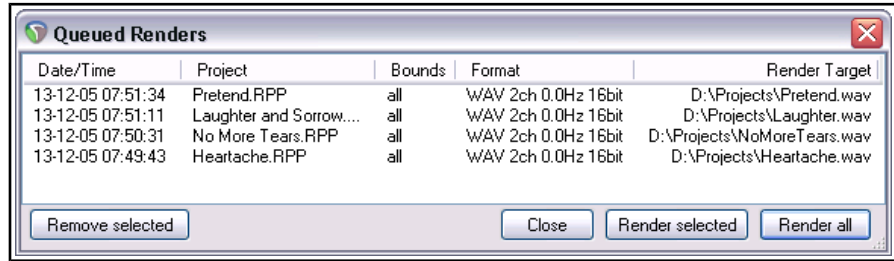

3. If you need to remove any item from the list, select it and click on **Remove Selected**.
4. *Either* use **Ctrl Click** to build up a subset of items to be rendered and click on **Render Selected** or simply click on **Render All** to render all items in the queue, each of course to a separate file. The **Rendering to File** box will be shown as each file is rendered and removed from the queue.
5. **Close** the Queued Renders dialog box when finished.

21.7 Rendering Selected Media Items

The **Selected media items** option in the Render drop down list can be used to render any media item or selection of media items. The procedure is:

1. Select the required item, or all required items in Arrange View.
2. Open the **File, Render...** dialog box.
3. Choose **Selected media items** from the **Render** drop down list.
4. Select your required output format and other options in the normal way.
5. Click on **Render xx files...** to render immediately, or on **Add to render queue** to do this later.



21.8 Rendering Regions

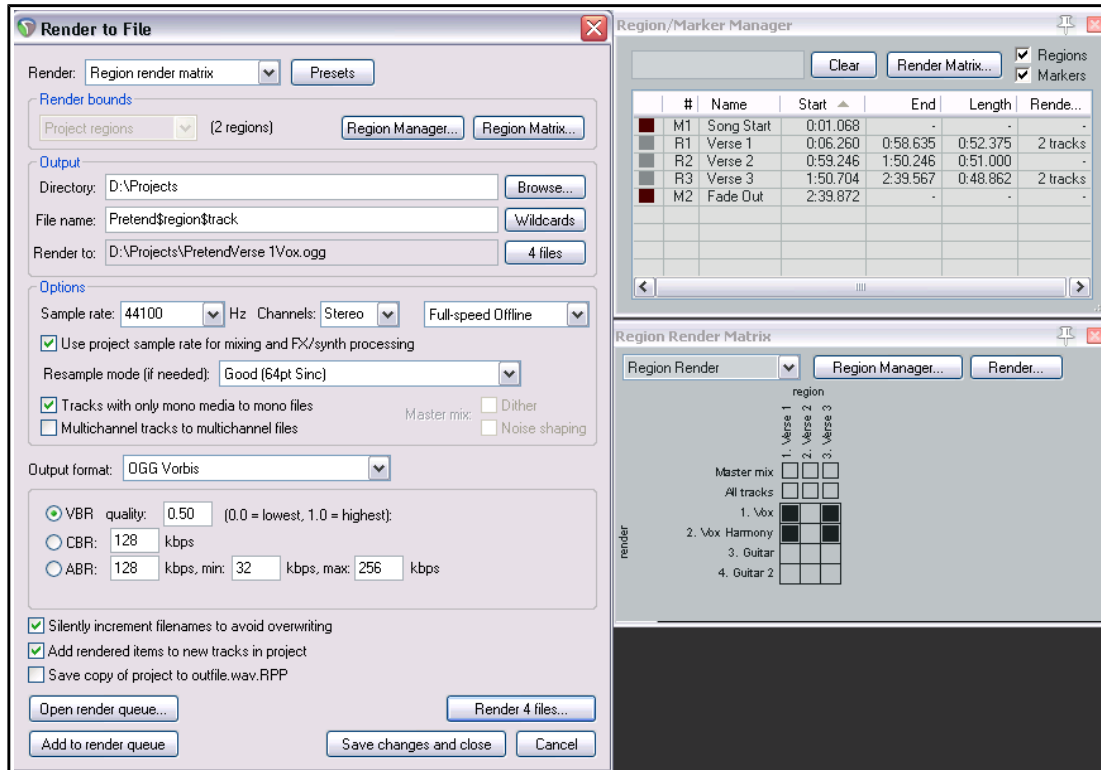

Up and Running: A REAPER User Guide v 5.24

This section requires you to have a sound knowledge of REAPER's regions, what they are, how to create/modify them and how to work with them. This is all explained in Chapter 9.

Rendering regions uses a combination of three possible windows: **Render to File**, **Region/Marker Manager** and **Region Render Matrix**. For the most part you will not need to use all three together, but it will help you if you understand how these three windows integrate.

You can select and render any permutation of tracks and regions you like. In the Render to File dialog you can include wildcards like \$region and \$track in the output file names. To display the Region Routing Matrix:

- ◆ From the main menu choose **View** then **Region Render Matrix**, or
- ◆ Click on the **Render Matrix...** button in the Region/Marker Manager window.
- ◆ In the **Render to File** dialog, select **Region render matrix** from the Render drop down list, then click on the **Region Matrix...** button (see below right).

To help you understand how this matrix works, take a look at the example here. This uses a simple project of four tracks. The song consists of three regions – Verse 1, Verse 2 and Verse 3 (see below right).

In the first column (Verse 1), only master mix (the first header row) is checked. This would result in one file being rendered for Verse 1. This file will be a master mix of all tracks.

In the second column (Verse 2) neither header row has been checked, but two tracks (Vox and Vox Harmony) have been. This would result in one file for each of these two tracks being rendered for this region.

In the third column (Verse 3) both the two header rows (master mix and all tracks) have been ticked. This would result in five files being rendered for this region – a master mix of all tracks, plus individual files for each of the four tracks.

You can make your selection in either the Region Render Matrix or the Region/Marker Manager – both are automatically updated. This is shown below:

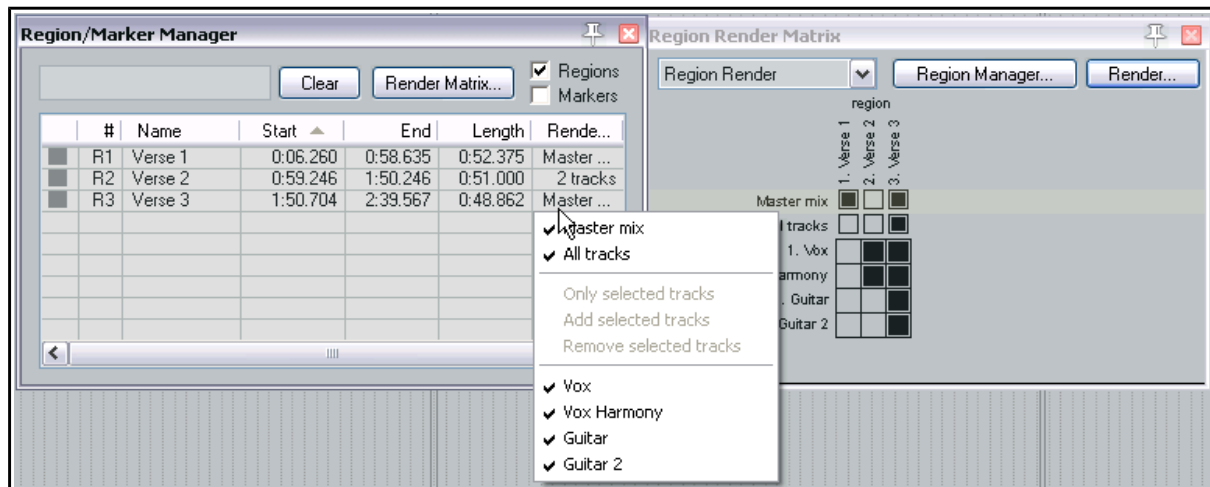
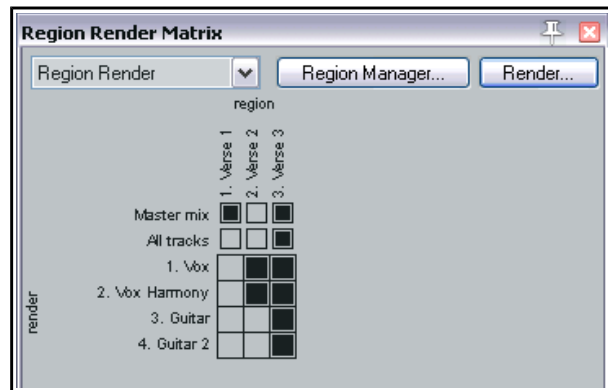

This window's right-click menu is shown here (below right). Options include **Render master mix for all regions**, **Render all tracks for all regions** and **Render master mix and all tracks for all regions**. From the **Region Render Matrix** you can open the **Render to File** dialog by clicking on the **Render** button.

21 - Exporting Files, Mixing Down and Rendering

Here you can select your options, output format, etc. Use a backslash in the file name wherever you wish to create subdirectories. If you choose, for example, as your file name **\$project\$region-\$track** then the output files produced will include the project file name, region name and track name, with each region's files being placed in its own separate sub-directory. The file name **\$project\$track-\$region** would include project name, track name and region name, with this time a separate subdirectory for each track.

When ready, choose **Render xx files...**, **Add to render queue...** or **Save changes and close** to proceed.

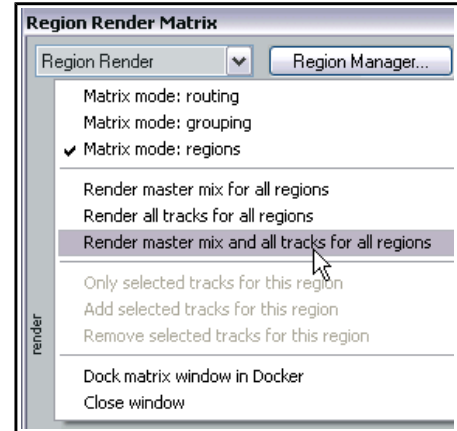

21.9 Burning an Audio CD with REAPER

There are at least two situations in which you might wish to burn your material direct to an audio CD.

1. You have recorded a number of songs. Each has been mixed and rendered to its own stereo wave file. You now wish to burn all of these to audio CD, with one track for each song.
2. You have perhaps a live recording comprising one continuous track. You wish to split it up into individual tracks, and then burn to audio CDs.

In both cases the procedure is similar, with some slight differences in how you set the project up.

Preparing to burn a CD from several mixed files

1. Start REAPER and create a new project file. Press **Ctrl Alt X** to display the **Media Explorer**, then navigate to the folder containing the rendered stereo wave files.
2. Double click in turn on each of the files that you wish to include in your CD program. REAPER will add each one to your project, lined up on separate tracks.
3. Notice that each media item is placed so as to begin immediately after the other, with no gap. It is not necessary to move any of these in order to create gaps on your CD. You will later be able to tell REAPER to do this automatically for you.
4. You will now need to insert a marker to indicate where each track is to start. To do this ...
5. First, make sure that Snapping is disabled. Place the cursor at the beginning of your project. Press **Shift M** to create and edit a marker at this point. Make sure the marker name begins with a **#** (as shown on the right).
6. Now move the cursor to the start of the next song. Again add a marker, and again make sure that the marker name begins with a **#**.
7. Repeat this until you have created a marker at the start of each song, as shown here:

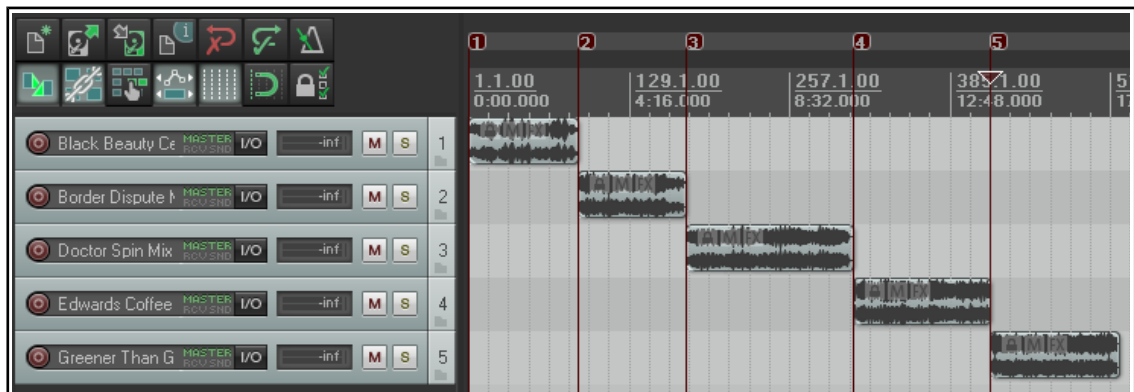
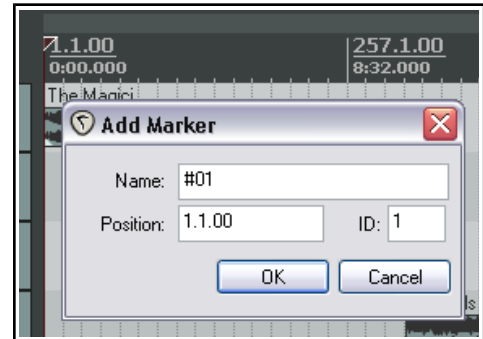

Up and Running: A REAPER User Guide v 5.24

8. Save the Project File.
9. Now follow the instructions below for **Burning the CD**.

Preparing to burn a CD from one continuous recording

1. If the recording was made in REAPER, open the project file. Otherwise, create a new project file and use Media Explorer to import the recording, using the method explained before.
2. It is *not* necessary to split up the media item. REAPER will take care of this when it burns the CD. However, you will need to indicate where you want each track on the CD to start.
3. First, make sure that Snapping is disabled. Place the cursor at the very beginning of your project. Press **Shift M** to create and edit a marker at this point. Make sure the marker name begins with a **#**.
4. Now move the cursor to the start of the next song. Again add a marker, and again make sure that the marker name begins with a **#**.
5. Repeat this until you have created a marker at the start of each song, as shown below:



6. Save the Project File.
7. Now follow the instructions below for **Burning the CD**.

Burning the CD

1. Choose the **File, Render** command. You should now select the necessary options and settings for burning your CD.
2. **Sample rate:** 44100
Channels: Stereo
Render entire project
Render Master Mix
Output format: Audio CD Image (CUE/BIN Format)
Markers define new tracks
Burn CD Image after render
Only use markers starting with #.

If you do not have any dithering plug-ins in your Master FX Chain, consider also enabling the **Dither** and/or **Noise Shape** options.

3. In the case of the first of our two examples (with separate media items lined up on different tracks) you might also want to specify a **Lead in silence for tracks** of 2000 ms.

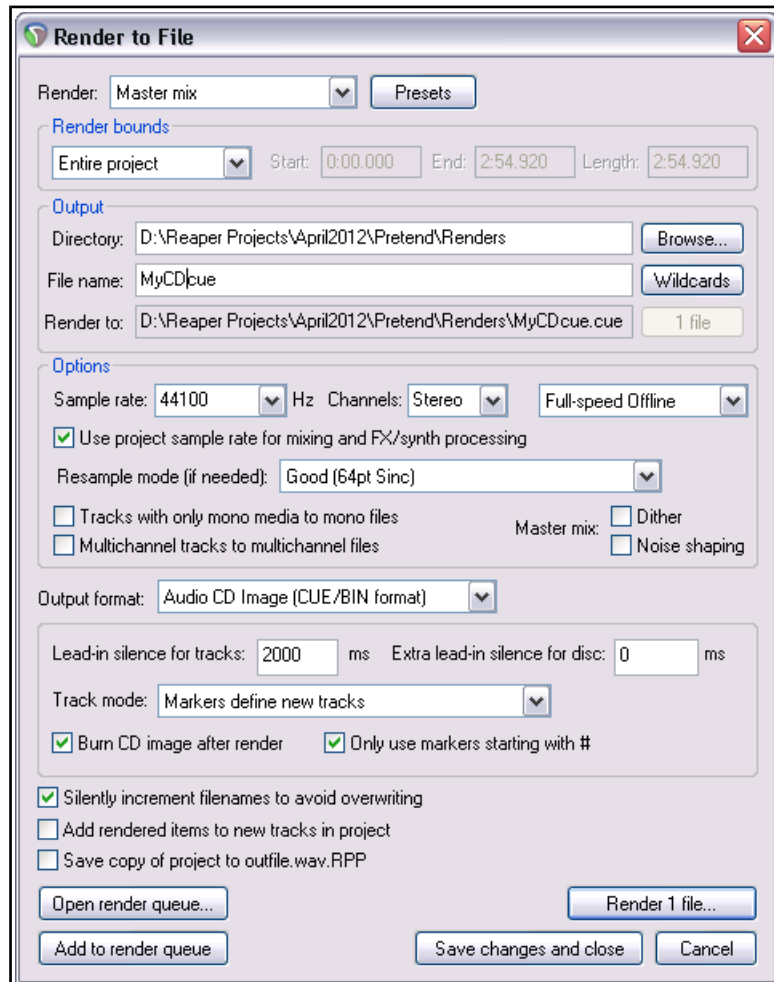

21 - Exporting Files, Mixing Down and Rendering

4. Click the **Render** button and wait for the output file to be rendered. This might take a few minutes.
5. When rendering has been completed, the **Burn Audio CD Image** settings screen will be displayed.
6. Select your preferred method. This will depend on factors such as your PC set up and operating system. If in doubt, choose **cdrecord/cdtools** as shown.
7. Select **Eject CD when done**. Decide whether you wish to keep or delete the CD image files when done. It's probably worth keeping it, at least for now. If you have any problems with burning the CD itself here, you might well be able to use the image file with another CD burning program such as Nero or Toast.
8. Insert a blank CD into your CD drive and wait for it to load.
9. Click **Burn CD**.
10. Wait while the **Burning in progress** message is displayed.
11. When finished, the CD will be ejected. Click on **Close** to close any messages still displayed on the screen.

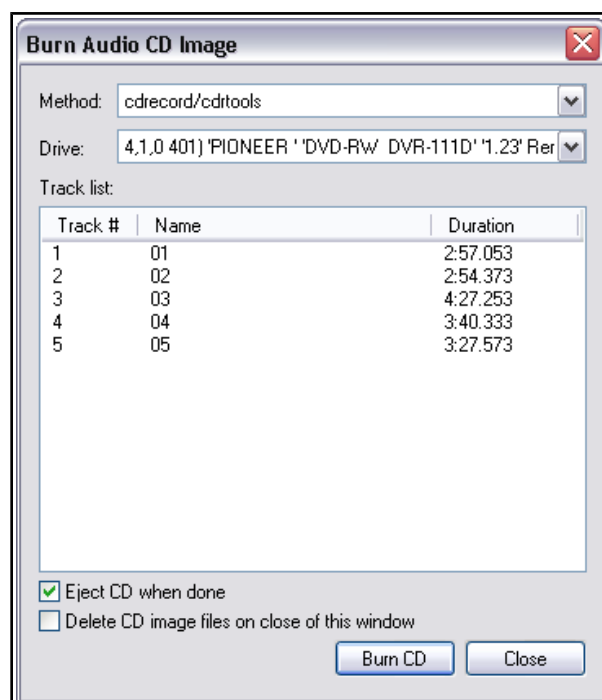

Instead of using markers to define the start of your tracks, you can if you wish create a separate **region** for each CD track and use the **Regions define tracks (other areas ignored)** option. Only that material which is included in your regions will be burnt to CD.

A further option is to burn the contents of the project as **One track**.

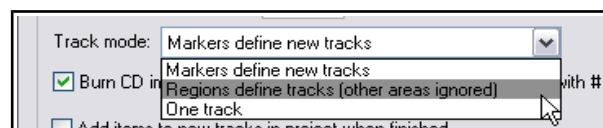

Tip: Before rendering direct to audio CD you should ensure that the media items that you are burning are in 16-bit 44100 Hz .WAV format.

There are a number of methods that you can use to convert them to this format. Probably the easiest is to set this under **Project Settings** as your **Media format for apply FX, glue, open, copy, etc.** Within the project you can then glue any existing media item(s), while any media items you then import will be automatically converted to this format.

21.10 Saving Live Output to Disk

You can export live output to disk, using the **File, Save live output to disk (bounce)** command. This is similar to **File, Render**, except that whereas the Render command works off line, Export Live to Disk works in real time. You can make adjustments on the fly to your settings while your project is being mixed down.

Position the play cursor at the start of the section you wish to save (e.g. the beginning) and choose the **File, Save live output to disk** command. Specify output directory, file name, output format, etc. Options include:

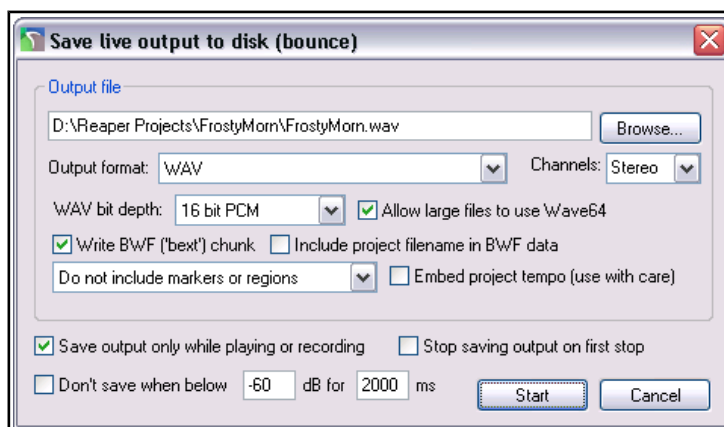

Whether to include markers and/or regions, or markers/regions with #names in the rendered output.

Up and Running: A REAPER User Guide v 5.24

Save output only when playing or recording: enables you to stop and start playback/recording whenever you wish, then later start again to resume bouncing to disk.

Stop saving output on first stop: ensures that bouncing will finish when you stop playback or recording.

It is unlikely that you would wish to enable both these options at the same time.

When you have made your settings, click on the **Start** button to begin bouncing. Choosing **Save live export to disk (bounce)** from the **File** menu will now cause the bounce to end.

This command has several uses, such as recording continuously a log of your sessions to a compact file format such as MP3, so that later you can hear everything that was said about each take even though the transport was stopped and nothing was being recorded on the tracks. One neat aspect of this is that you can use REAPER's media explorer window to locate and play back this file even while it is still being recorded.

If you do set this to run non-stop, however, remember to stop the recording when you no longer need it, to avoid creating an unnecessarily large file.

21.11 Using Presets

You can save your render settings as presets, and recall them when you wish to use them again – render bounds and output settings, or options and format settings, or all settings. Click on the **Presets** button (in the **Render to File** dialog box) to display the menu for doing this. Your presets will automatically be added to the appropriate menu (see example, right).

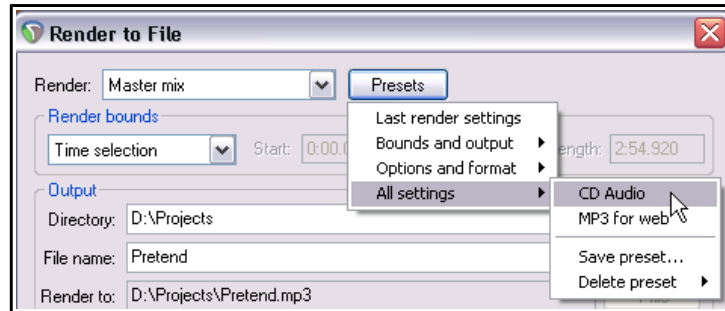

21.12 Rendering in Surround Format

When you are rendering a project for surround format, most of the settings will be made as for any other project (such as a stereo mix).

The one important difference is that you should be sure to select the correct number of channels.

In the example shown here, the project is for 5.1 surround, therefore 6 channels have been selected.

REAPER will render this project into a single multichannel file. You may later need to convert the interleaved multichannel file into multi-mono files of the type required by Dolby and DTS encoders.

REAPER itself does not do this easily, but there are a number of good tools available which will do this for you.

These include **Wave Agent** - <http://www.sounddevices.com/products/waveagent.htm>.

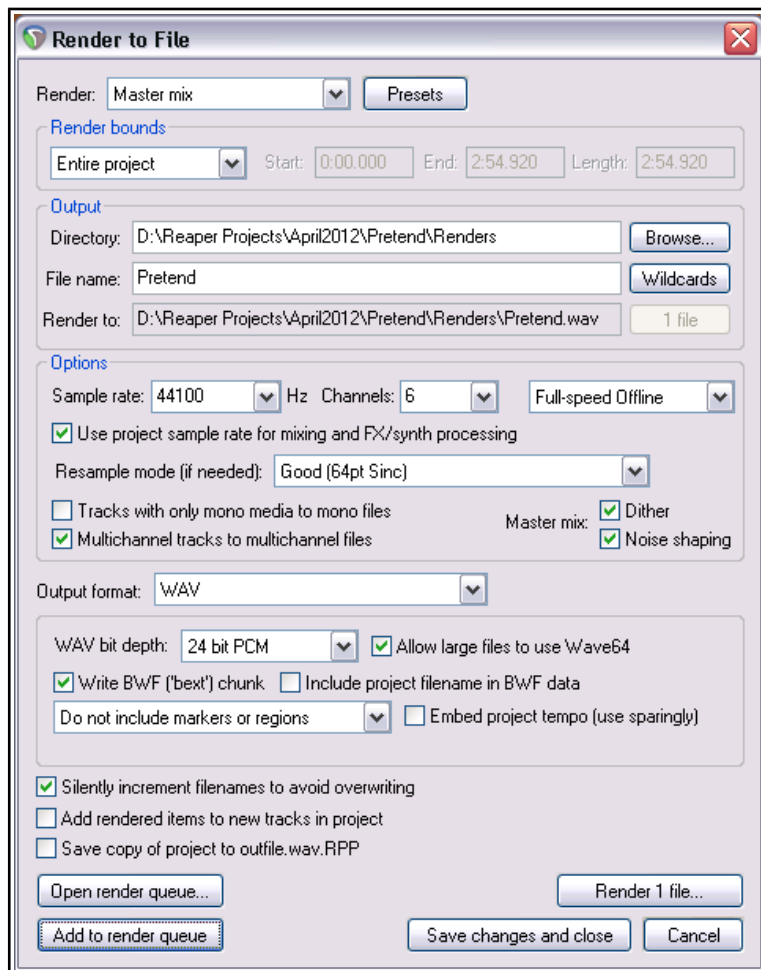

21.13 Rendering a Video Project

The process for rendering a video project is similar to that for rendering audio projects, but with a small number of options and settings that are specifically video oriented.

Most options within the **File, Render...** dialog serve the same purpose as they do for audio projects and do not need any further discussion here.

These include render bounds, output files names and directory locations, sample rate, etc. The important differences can be found in the **Output format** section.

Output format: Video(GIF) is an option if your project contains no audio, but mostly you will want to select **Video(libav/FFmpeg encoder)**.

You will then need to select a container **format**: options are AVI, QT/MOV/MP4, MKV or WEBM. Your choice of **video codec** and **audio codec** will depend on which container format you have chosen.

This will cause audio content to be rendered in your chosen format. You can select your preferred size and frame rate from the available list (see below). Frames per second range from 24 to 30 and sizes range from 320 x 240 (QVGA) up to 1920 x 1080 (Full HD). There are also options to

Keep source aspect ratio and **Get width/height/ framerate from current video item**.

If you are using the **Video(libav/FFmpeg encoder)** you will use the **Video codec** VP8 and **Audio codec** VORBIS.

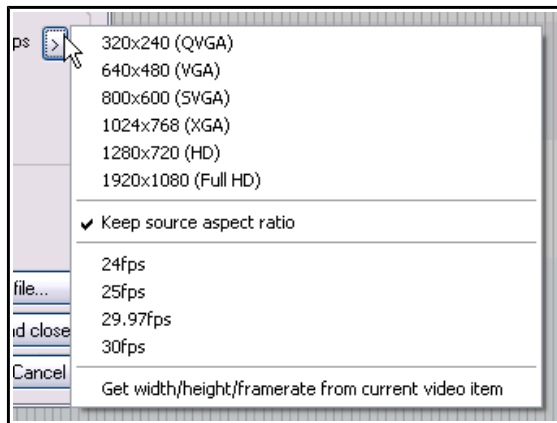
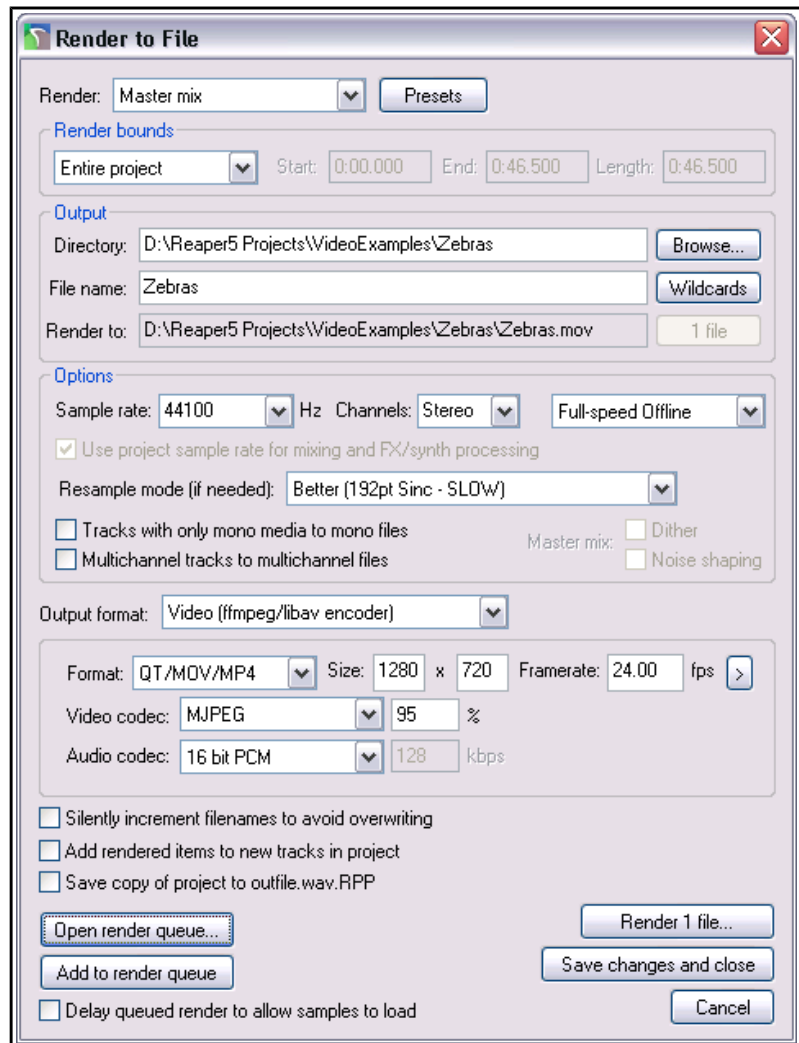

The remaining options have already been explained. These include the options to **Add to render queue** for processing later or **Render file** in real time now.

22 REAPER's Preferences and Other Settings

22.1 Introduction

At several places in this User Guide we have encountered the use of preferences and settings. In this chapter, you will learn other ways in which you can use REAPER's preferences and other settings to tailor the program more closely to your particular requirements. Don't worry about the sheer number of options available. In many cases, you'll probably be perfectly happy to leave the program settings as they are and just let it run.

Not all of the options and preferences are covered in this chapter. If you need any further information about any of REAPER's other preferences and settings, go to the REAPER WIKI or the REAPER forums.

22.2 General Preferences

Most of the settings on the **General** page fall into one of the following categories:

- ◆ **Language:** Select from list any available language, or option to prompt when REAPER is loaded. There is also a URL link to **Download language packs**.
- ◆ **Import and Export.** These buttons can be used to consolidate, save and export your various settings and configurations to a ReaperConfigZip file, or to import them from such a previously saved file (more details on next page).

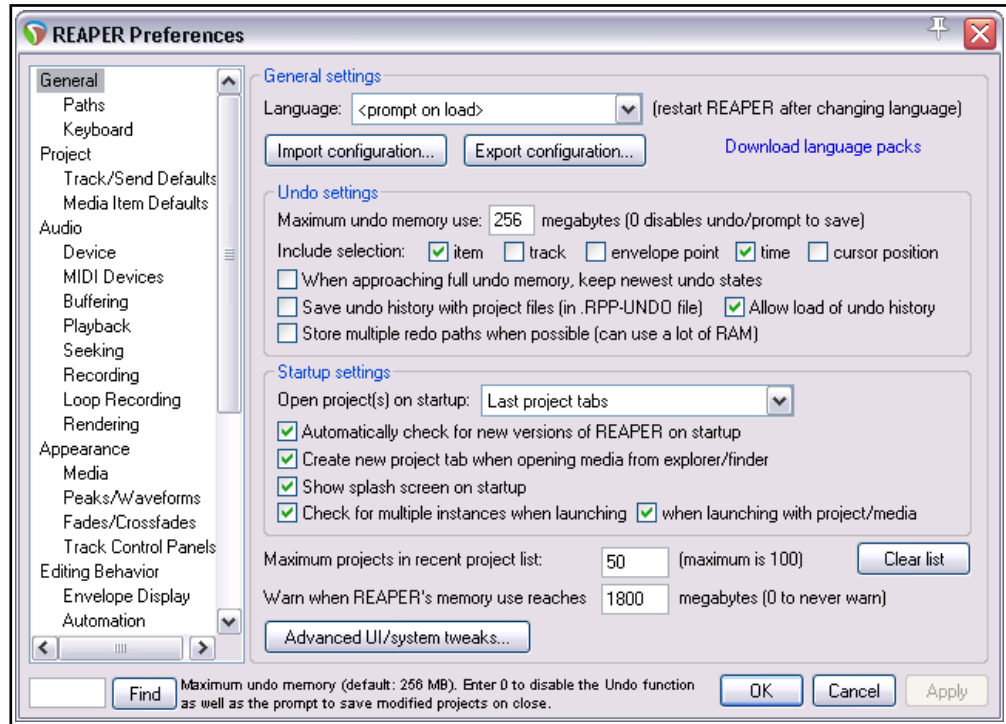

- ◆ **Undo Settings.** These are explained in Chapter 2 and re-examined near the end of this chapter.
- ◆ **Startup Settings.** Enable or disable various options. **Open projects on startup** allows you to choose from **Last active project**, **Last project tabs** (i.e. all projects open when REAPER was last closed), **New project ignoring default template**, **New project**, or **Prompt**. Choosing Prompt will cause you on startup to be offered a choice which includes last active project, last project tabs, a new project (using or ignoring the default project template), any project template, or any file on the recent projects list.
- ◆ Other options include **Show splash screen on startup** and **Automatically check for new versions of REAPER**. There is also an option to **Create new project tab when opening media** (directly) from Windows Explorer or OS X Finder.
- ◆ **Check for multiple instances** can be disabled if you want to allow more than one REAPER instance to be open at the same time.
- ◆ **Recent Project List.** This setting determines the maximum number of files that will be displayed on your File, Recent projects menu. You can also **Clear the list**.
- ◆ **Warn when memory usage high:** Suggested settings are 1800 for 32 bit, 3800 for 64-bit REAPER.
- ◆ **Advanced UI System Tweaks.** These allow for a number of options, including the scaling of UI elements such as your icons and panels. We'll deal with these later in this chapter.

22.2.1 Import and Export Configuration

Export configuration can be used to export to a .ReaperConfig.Zip file any permutation of your settings.

Import configuration can be used to import a previously saved settings file back into REAPER. This can also be done by dragging and dropping a .ReaperConfig.zip file from Explorer or Finder into REAPER's arrange window. You will be prompted to confirm that you really want to do this.

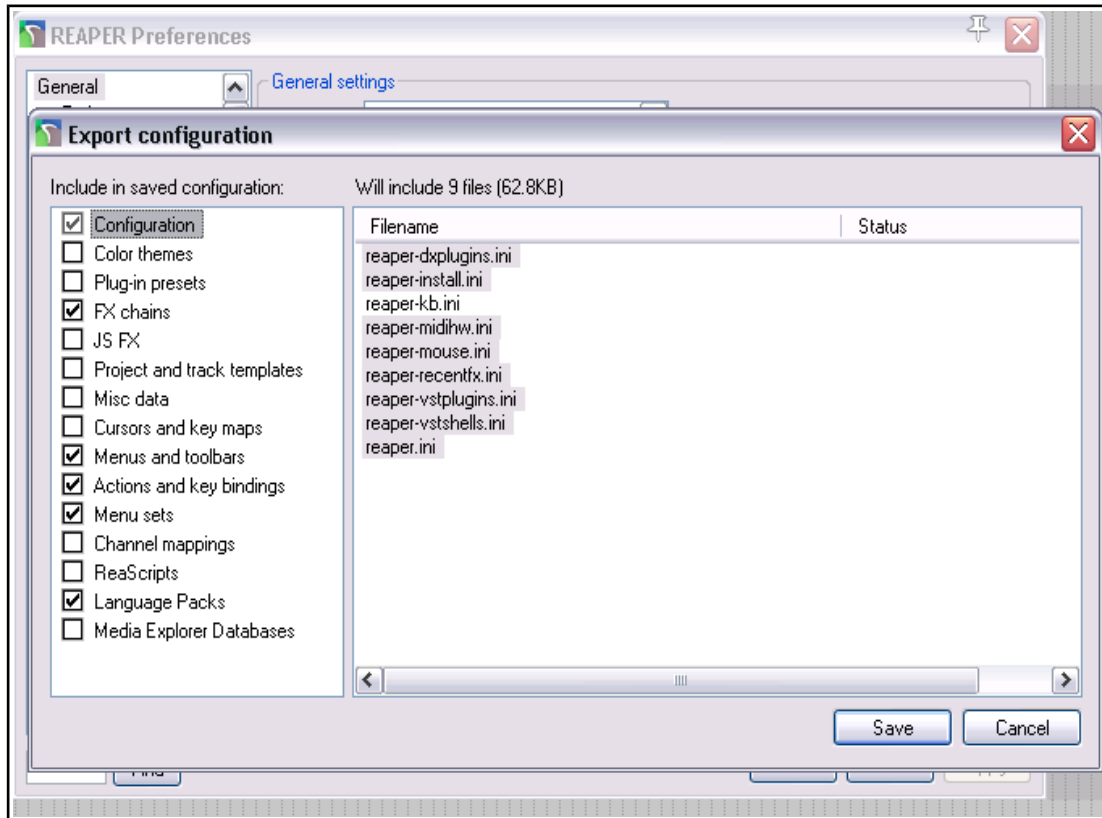

Any permutation of the following elements can be selected for inclusion in a ReaperConfig.zip file:

Configuration	Project and track templates	Menu sets
Color themes	Miscellaneous data	Channel mappings
Plug-in presets	Cursors and key maps	ReaScripts
FX Chains	Menus and toolbars	Language Packs
JS FX	Actions and key bindings	Media Explorer Databases

In the first column, tick the categories to be included. The second column will then show you which files have been selected for inclusion in your ReaperConfig.zip file. The files associated with any category will be highlighted in the right column when that category is selected. In the example above, Configuration is the selected category. After making all your selections in the first column, use the **Save** button to create the file.

Import and export configuration exists side by side with the individual import/export options that are available within many of REAPER's different elements. For example, to export only your actions and key bindings you would be most likely to use the **Import/export...** button within the Actions window.

If, on the other hand, you wish to export your actions and key bindings along with various other settings, such as perhaps menu sets, FX chains and ReaScripts (perhaps to be imported into REAPER on another computer), then you would be more likely to use the screen shown above.

Tip: It can be a good idea to create a .ReaperConfig.zip file that includes **all** the above elements and keep a copy as a backup on a CD, eternal hard drive or flash drive (or all three!) in case of system failure.

22.2.2 Paths and Keyboards

Within the **General** preferences category you will find two more pages – **Paths** and **Keyboard**.

Paths

You can set (separately) default paths for REAPER to use when **saving** new projects, **rendering**, **recording**, and/or for storage of **waveform peaks**. The last of these will only be applied if under Preferences, Media the option to **Store all peak caches in alternate path** is enabled.

If no render path is specified, the project directory will be used.

You can set a relative path for rendering. For example, if you specify simply *Mixes* as your default render path, then this will be used as a default relative path when you open the **File, Render** dialog box. If you accept this default when rendering, a sub-directory of that name will be created in the project directory. For example, if you have a project called *Hello* stored in a folder C:\REAPER Projects\Hello, then your rendered file(s) for that project will be placed in a directory C:\REAPER Projects\Hello\Mixes.

Alternatively, if you specify (for example) *C:\Mixes* as the default render path, then by default, C:\Mixes will be used as the absolute output directory for rendered files, regardless of where the project is located.

Keyboard

This page consists of two main sections – **Keyboard** and **Multi-touch**.

The **keyboard** section includes the following:

Commit changes to some edit fields after 1 second of typing. Enabled, this allows, for example, a play rate to be typed in to the relevant Transport Bar field without your needing to press **Enter**

Use alternate keyboard section when recording. You must enable this if you wish to use your Main (Alt recording) keyboard shortcuts when recording.

Prevent ALT key from focussing main menu. Enabling this will stop the main menu getting focus when the Alt key is pressed.

Clicking on either of the two links in this window will open the action list editor (Assign keyboard shortcuts ...) or your web browser with a list of keyboard shortcuts (View keyboard shortcuts as).

The other section allows you to customize the behavior of a **Multi-touch** trackpad or similar device. Refer to the Preferences, General, Keyboard window and your device's documentation for a list of options.

22.3 Main Project Preferences

REAPER's main **Project** settings page is in some respects less interesting than either of its two sub-pages (see below). Nevertheless, it has some useful items, including:

- ◆ The option to specify a **default .RPP** file to use as a **template** when starting new projects.
- ◆ Whether to prompt you to save whenever a new project is created. This can be a useful reminder to you if you wish to use a separate sub-directory for the project and its media files.
- ◆ Whether to **open** and display **the project properties window** when a new project is created. This can serve as a handy reminder, for example, if you need to set a project time signature or timebase that is different from your default.
- ◆ Whether to prompt you with a warning if a project that you are attempting to load cannot be found. This can happen, for example, when an older project has been deleted but remains on the Recent Projects list.
- ◆ Whether to show the file load status and REAPER's splash screen when a project is loading.
- ◆ Whether to save project file references with **relative pathnames**. This can be useful, for example, if a project is likely to be moved from one disk to another.
- ◆ When using **File, Save As** to over write an existing file, whether to create **multiple versions**.
- ◆ Whether to **automatically create a backup** file (.RPP-BAK) from the previously saved version of a project file when it is resaved, and if so whether to timestamp it. Enabling these options can be a wise precaution to help you recover data if, for example, a project file becomes corrupted.
- ◆ Whether to **auto-save** your projects and, if so, at what intervals. The default (if this is enabled) is 15 minutes. This can help prevent work from being lost due to power outages or computer crashes.
- ◆ Whether to include your **Undo history** when the project is being auto-saved. This option will only be applied if saving undo history is enabled in your General preferences.

22.3.1 Project Track/Send Defaults

As the page name implies, you'll find two groups of default settings here – one each for **Tracks** and **Sends**.

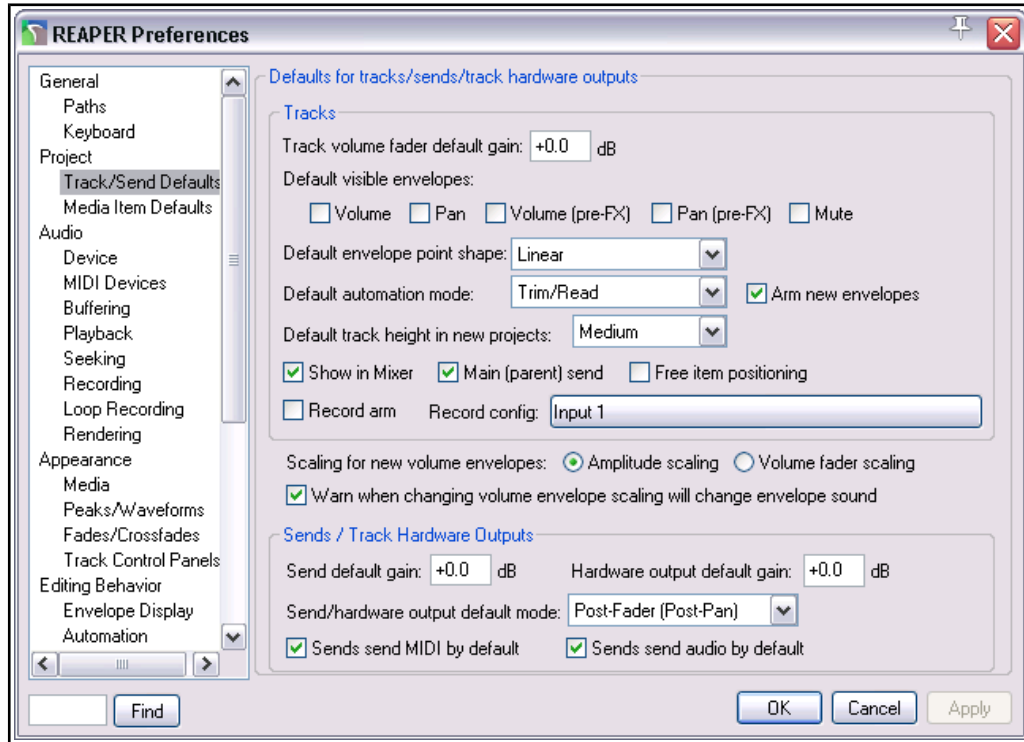

- ◆ **Track volume fader default gain:** sets the initial volume fader level for new tracks. Default is 0.0 dB.
- ◆ **Default visible envelopes:** allows you to specify any track parameter envelopes (e.g. Volume, Pan) that you would like automatically displayed for new tracks.
- ◆ **Default envelope point shape:** sets the shape for new envelopes (e.g. Linear).
- ◆ **Default automation mode:** sets automation mode (e.g. Trim/Read) for new tracks.
- ◆ **Default track height in new projects:** choose from small, medium and large.
- ◆ **Show in mixer:** whether or not new tracks by default are shown in Mixer.
- ◆ **Main (parent) send:** whether send to Master (top level tracks) or parent folder (child tracks) is by default enabled for new tracks.
- ◆ **Free item positioning:** whether FIPM is by default enabled for new tracks.
- ◆ **Record-arm:** whether new tracks are automatically armed for recording.
- ◆ **Record config:** click to set default recording settings for new tracks (see right): e.g. whether monitoring is on, whether to record audio input or MIDI, default input source.
- ◆ Whether **scaling** for **volume envelopes** should default to amplitude or fader.
- ◆ **Sends/Track Hardware Outputs Send default gain:** default volume fader level for new track sends.
- ◆ **Hardware output default gain:** default volume fader level for new hardware sends.
- ◆ **Sends/hardware output default mode:** default send type (e.g. Post fader/Post pan).
- ◆ **Sends ... by default:** whether sends by default include audio or MIDI or both.

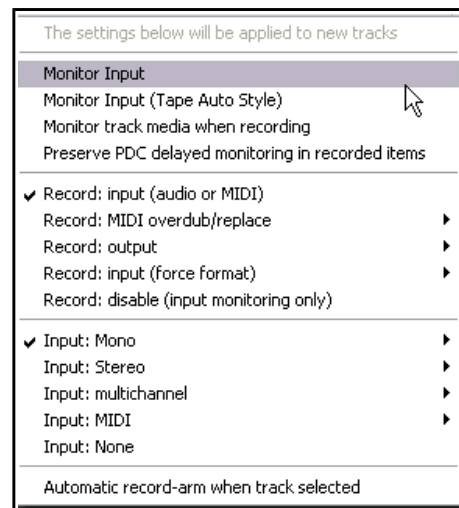

22.3.2 Media Item Defaults

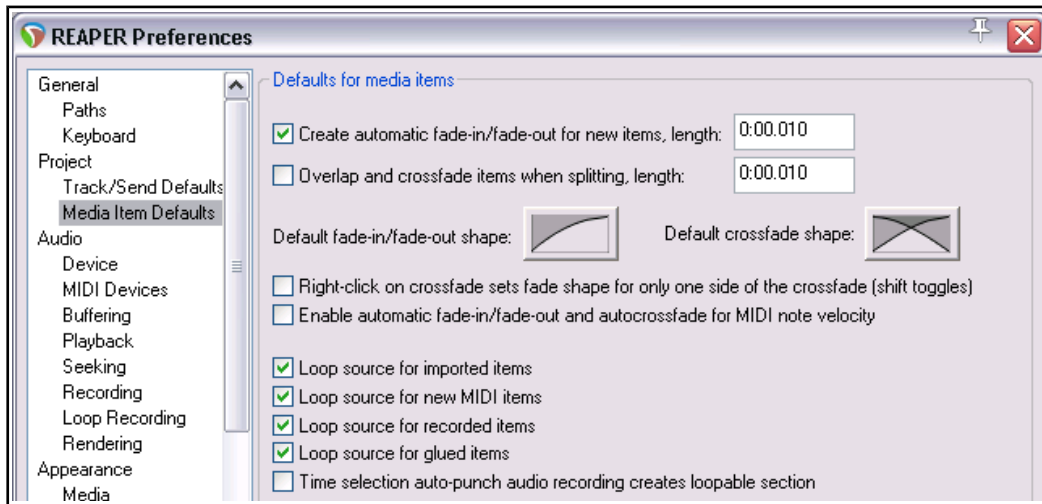

REAPER's **Media Item Defaults** include:

- ◆ Whether to use automatic fade-ins/fade-outs on new items, and if so how long they should be.
- ◆ Whether to overlap and split crossfade items, and if so by how much.
- ◆ Default fade and cross fade shapes.
- ◆ Whether right-clicking on one side of crossfade set should change only that side (use **Shift** to toggle).
- ◆ Whether to allow automatic fades and crossfades for MIDI note velocity.
- ◆ Whether to loop source imported items and/or new MIDI items and/or recorded items and/or glued items.
- ◆ Whether time selection auto-punch audio recording should create a loopable section.

22.4 Audio Configuration and Settings

We've already mentioned (Chapter 1) the **Audio Device** screen (in the **Preferences** window), but it's worth discussing this topic a little more.

Two important issues in the digital audio world concern **buffers** and **latency**. Understanding what these terms mean will help you in obtaining the optimum settings for your system.

Getting buffer size right is essential if you are to get the best performance from your audio interface. Make them too small and you'll get audio clicks and pops; make them too large you'll notice delays in your headphones when you're input monitoring, especially with software synthesizers.

The goal is to achieve the lowest possible latency without experiencing dropouts. The optimum setting depends on a number of things, not least of which are the audio interface (PCI sound card, firewire or USB device) that you are using, your PC's characteristics, as well as which software you're running. The use of plug-ins can also increase latency, some more than others.

Consider what happens when you are working at your DAW. As you play back your tracks, a constant stream of data passes from your hard disk and/or RAM to your sound card. Amongst other things, this converts the digital data to an analog form, so that it can be sent to, and heard thru, your speakers or headphones. When you record the reverse happens – the incoming analog audio stream has to be converted to a digital format so that it can be stored on your hard disk.

When you are overdubbing, both of these activities are going on at the same time. Indeed, with input monitoring, the track or tracks being recorded are actually being fed into the computer in analog form, converted to digital, processed, then converted back to analog again as they are fed back to your headphones. Latency is a measure of this delay. Incidentally, you can make this activity easier if your audio device itself supports input monitoring. In this case, the incoming audio stream that is being recorded is fed straight back into your headphones before it even gets into the computer.

Up and Running: A REAPER User Guide v 5.24

As if this wasn't complicated enough, remember that Windows is performing all sorts of other tasks at the same time as you are recording. If you don't believe this, just bring up Task Manager some time, check the **Processes** page and have a look. That's what we mean by **multitasking**.

So how is Windows able to keep up with its other 99 or so tasks at the same time as handling your recording? It does so by dividing its resources between all the tasks at hand. In order to maintain a constant audio stream, small amounts of memory are allocated to storing this audio stream. These areas are called buffers.

Thus, as you play back your audio, Windows hands over to your sound card a block of audio that the sound card releases at a steady rate to your external amplifier. If it empties these buffers before Windows gets round to handing it some more, then you've got a problem. The same principle applies, but in the reverse direction, when you're recording. And again, when you're layering or overdubbing, or using REAPER's input monitoring, both activities are going on at the same time.

If the buffers are too small, you'll get gaps in the audio stream. These can lead to pops, crackles and in some cases even dropouts (that's when playback and/or recording just stops suddenly and unexpectedly). Making buffers larger is usually enough to fix this problem, but it brings with it another. Make them too large, and the data at the end of the buffer has a long wait before it is processed. That's when you experience unacceptably large latency, such as the delay between pressing a keyboard and hearing the note in your headphones.

ASIO drivers generally offer better latency than do others. As a rule, the preferred order is ASIO, WDM, DirectX and MME, in that order. This is where the **ASIO Configuration** button on the **Audio Device** screen is so important (assuming, of course that you are using ASIO drivers).

The smaller the buffer size, the greater the load on your computer's CPU.

So after making changes to your buffer size, check the CPU usage on REAPER's Performance Meter.

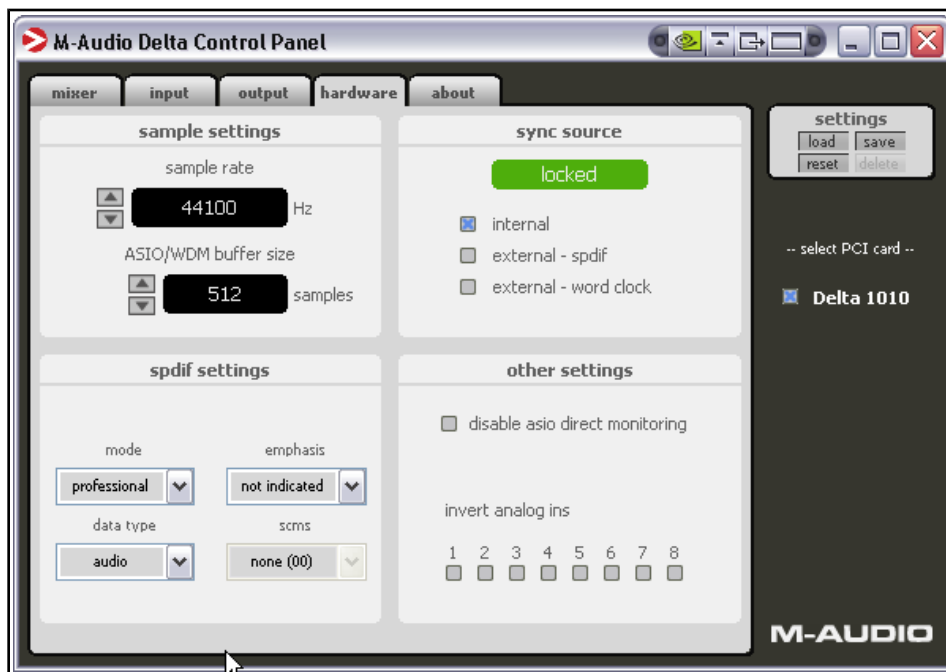

You can use this fact to your advantage when mixing.

As a rule, low levels of latency are only really needed for recording, not when you are only playing audio back. Therefore, if you find that you are pushing your CPU close to its limits, you will often be able to fix this by accessing your audio card's control software and increasing the buffer size.

Finally. Just a word about **Sample Rate**. This also affects CPU usage. Going from 44100 to 88200 doubles CPU usage.

This is an area about which there is much debate, but in reality few of us have ears that can really detect whether a track has been recorded at 44100 or at 88200. Test this out for yourself and see what you think.

Another important aspect of your Audio preferences is your **MIDI Devices** settings page. This has been covered in Chapter 1.

22.5 Audio Preferences

This page presents you with a range of audio preferences and options. Many, if not most, users will find they can leave at least the first half dozen or so of these at their default settings and forget them.

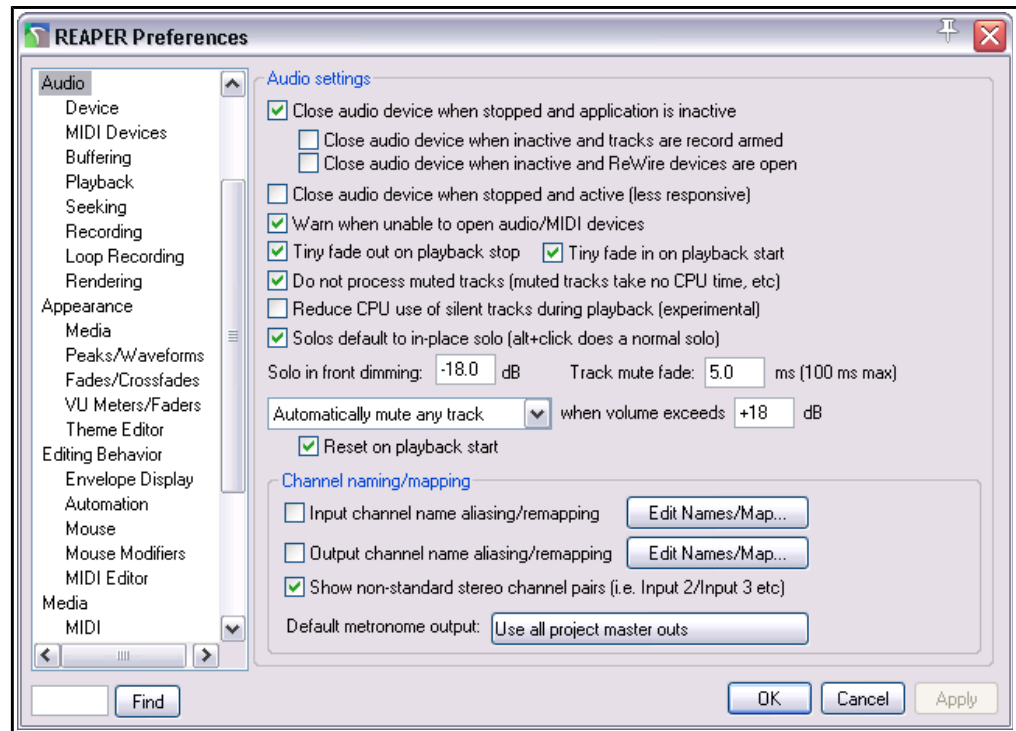

- ◆ Whether to **Close audio device when stopped and application inactive**. Enabled, this allows you to have other audio programs (such as Sound Forge) open at the same time as REAPER, and for you to be able to switch easily between them.
- ◆ **Close audio device when inactive and tracks are record armed**. Leave this unselected if you want REAPER not to share your audio device with other programs when you have record armed tracks.
- ◆ **Close audio device when stopped and active**. If enabled, REAPER will automatically close audio devices when audio is not being played back.
- ◆ Enabling **Warn when unable to open audio/MIDI devices** could potentially help you to troubleshoot if you encounter hardware interface issues.
- ◆ Enabling **tiny fades** on playback start/stop can help prevent clicking.
- ◆ Enabling the options **Do not process muted tracks** and/or **Reduce CPU use of silent tracks during playback** could lessen the load placed on your CPU.
- ◆ **Solos defaults to in-place solo**. If enabled, when you solo a track you will hear along with that track the audio output of any other tracks with receives from that track. Disabling this ensures that you will hear only the soloed track. In either event, holding **Alt** while clicking solo will reverse your default option.
- ◆ **Solo in front** allows you to hear quietly in the background your other tracks when one or more tracks are soloed. This may help you to place more in context the track that is being auditioned. The feature itself is enabled/disabled from the **Options** menu: in your preferences you can set your preferred dB level for the background material.
- ◆ You can **Automatically mute any track** or only the **Master track** when a specified dB limit is reached. This option can help protect your ears, your speakers and your sound card! A third option is **No automatic muting**. There is also an option to **Reset** (clear auto mutes) on playback start.
- ◆ **Channel naming/mapping**. This feature enables you to give your own meaningful names to your audio input and output devices. It is explained in detail in Chapter 1.
- ◆ Output to be used for **Metronome Output**.

Note that **Audio, Device** preferences and settings are explained in Chapter 1.12 and **Audio, MIDI Device** preferences and settings in Chapter 1.15.

22.5.1 Audio Buffering

While we're looking at optimising audio, the **Audio Buffering** page of the **Preferences** window contain a number of customization options.

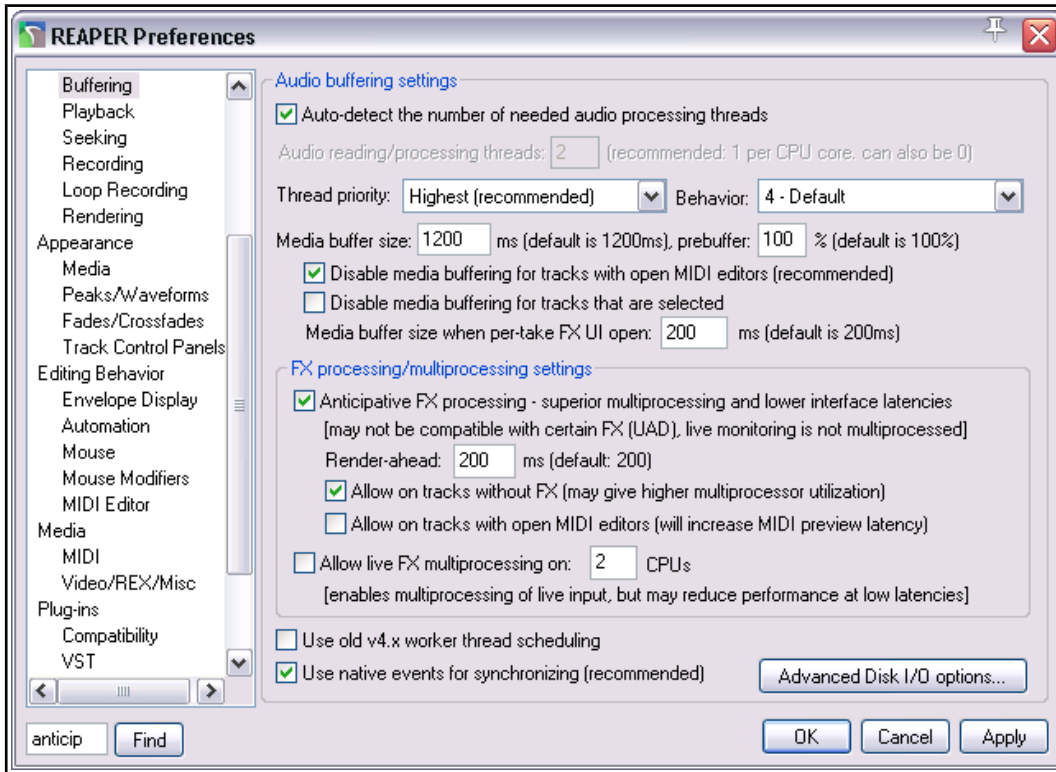

The option **Disable media buffering for tracks that are selected** can be useful if using a third party plug-in that does not respond well to buffering. Otherwise, if you are not technically minded you would be best advised to leave most of these settings at their default values. If your computer has two or more processors, you might find the following options useful.

Anticipative FX processing has benefits for both multiprocessor and single processor systems. On single processors it makes REAPER more tolerant of lower interface latencies (and more resistant to plug-ins that do larger block-based processing, such as ReaVerb and ReaFir). On multiprocessor/multicore systems it also allows for very significant multiprocessor usage. Enabling this feature can allow improved latency. However, **allowing FX multiprocessing when a MIDI editor is open** will increase preview latency. On some Windows 8 or OS X Mavericks configurations, enabling **Use new alternate worker thread scheduling** might lead to improved performance.

Notice also that clicking on the **Advanced Disk I/O Options** button brings up the selection of options shown on the right.

If unsure about what you are doing, it's better to leave these settings at their defaults. Any changes you do make should not come into effect until after closing and reopening your project file.

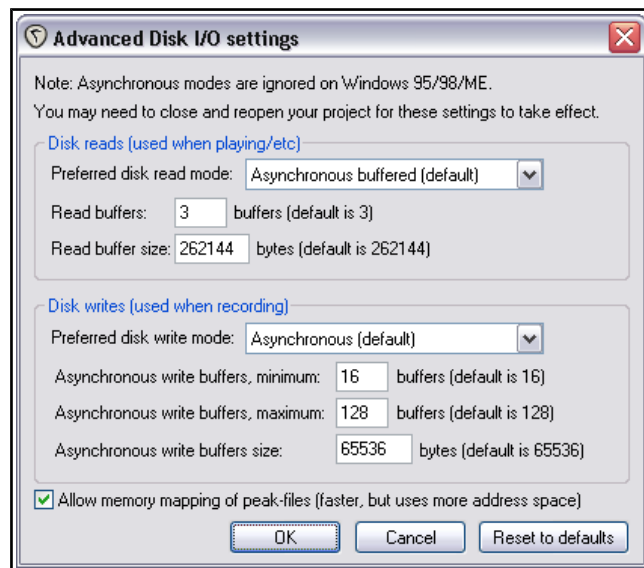

22.5.2 Audio Playback

Options include whether or not to:

- ◆ **Stop/ repeat playback at project end.**
- ◆ **Stop playback at the end of a loop** if repeat is disabled.
- ◆ **Scroll the view to the edit cursor position when playback is stopped.**
- ◆ **Auto-scroll** when viewing other parts of a project.
- ◆ **Run FX after playback is stopped:** helps evaluate the "after effect" of delay based plug-ins such as reverb and chorus.
- ◆ **Send MIDI note-offs when un-record-arming a track.**
- ◆ **Reset MIDI CC/Pitch** on playback start and/or playback stop and/or playback loop/skip.
- ◆ **Enable scrubbing and jogging,** and if so what options to apply (such as limiting jog/scrub rates).

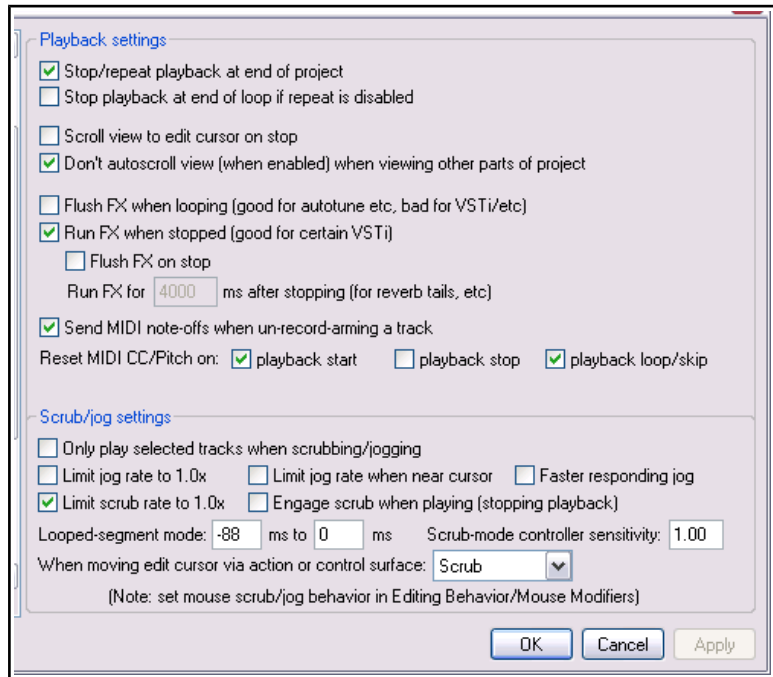

Note that there is also a command on the **Options** menu to enable/disable **Continuous scrolling**.

22.5.3 Audio Seeking

Options include whether or not to:

- ◆ **Seek playback** (repositioning the play cursor) when clicking on any of the top ruler, empty areas of tracks, and/or empty areas below tracks. Disabling any of these will enable you to click or click and drag in arrange view (for example, on the ruler to define a loop, or in the empty area between tracks to define a time selection) without affecting existing playback.
- ◆ **Seek playback when loop points are changed** and/or **Only when repeat is enabled.**
- ◆ **Seek playback when an item is moved/sized or has its fade adjusted.**
- ◆ Specify playback position should **follow the project timebase when changing tempo.**
- ◆ Use **smooth seek:** this enables you to allow playback to continue to the end of a specified number of measures, or to the next marker or end of region, before seeking.

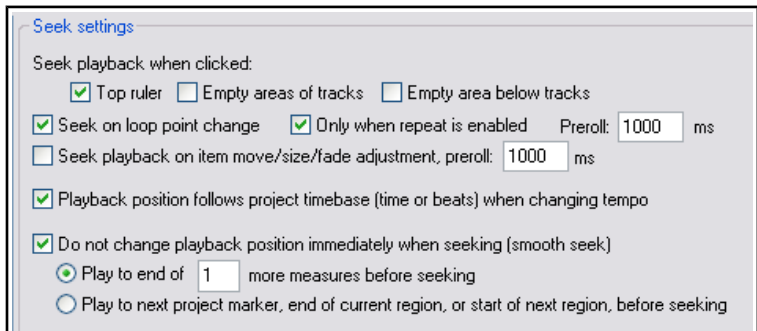

22.5.4 Audio Recording

Audio Recording preferences are detailed and explained in Chapter 3.

22.5.5 Audio Loop Recording

This page of settings determines how REAPER behaves when loop recording.

- ◆ **Discard incomplete first or last takes if at least one full loop was recorded.** This prevents annoying and unwanted partial takes being saved, as might be caused if you are a tad slow in stopping recording. There is an option to define at what threshold (default 90% of loop length) the recording should be considered to be complete.

- ◆ **MIDI recording within empty time selection always creates selection-length media item.** Enable this to ensure MIDI media item matches time selection length.
- ◆ **Add recorded media to project on stop.** Ensures that media will not be added to the project until recording is stopped. Optionally, you can **create new files** for each recorded pass thru the loop.
- ◆ **Add recorded media to project at each loop.** Ensures that recorded media is added on the fly after each pass thru the loop.

22.5.6 Audio Rendering

These are found on the page after **Audio Loop Recording** preferences. They are rather technical: if you are unsure of what to do, leave them at their system defaults:

- ◆ Block size to use when rendering samples. If in doubt, leave blank.
- ◆ Whether to allow anticipative FX processing. This may lead to better multiprocessing performance (default is on).
- ◆ Whether to limit apply FX/Render stems to realtime (default is off).
- ◆ Whether to process all tracks (including if appropriate muted and/or unsoloed tracks) when rendering. Makes rendering slower, but some plug-ins might need this.
- ◆ Specify FX tail length and whether to apply when rendering entire project and/or time selection/regions, and/or selected media items.
- ◆ When freezing, whether to render entire track length if there are track or per take FX.

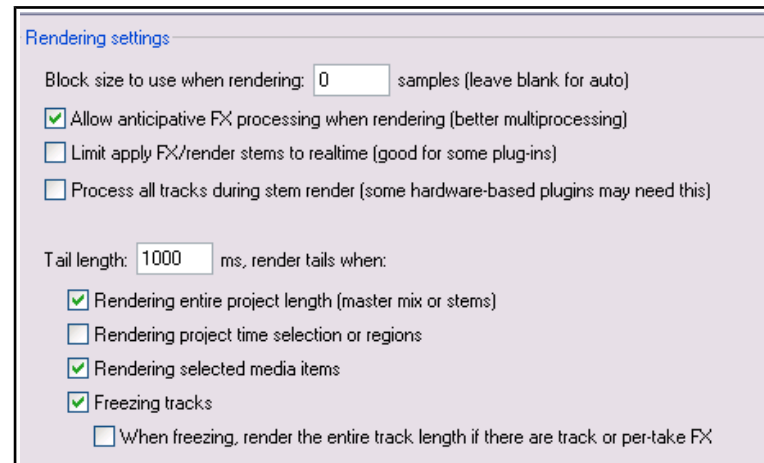
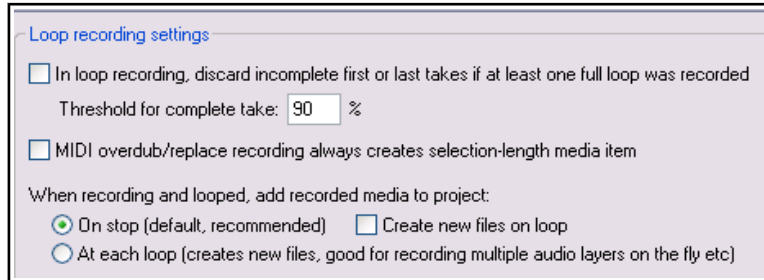

22.6 Appearance Preferences

The **Appearance** screen itself lets you specify various parameters that help determine the appearance of your REAPER interface, especially the Track Control Panel and Mixer. Here is a summary of some of the options:

Miscellaneous Appearance Settings include:

- ◆ Whether to use **tooltips for UI elements** such as buttons and faders, media items and envelopes, etc.: if so you can specify the length of any delay that should be allowed before the tooltip is displayed.
- ◆ The **width (in pixels) of the play cursor**. Default is 1 pixel, but you can make this wider.
- ◆ You can specify a **maximum distance (pixels) between ruler text labels**.
- ◆ Whether to **show the last undo event on the menu bar** (just after the Help command). If you enable this option, clicking on the action shown will open the Undo History window.
- ◆ Whether to **show guidelines when editing**. This can be an aid to editing. Whether to **apply solid edges** to time selection highlights. and/or loop highlights.
- ◆ Whether to **limit the scaling of toolbar buttons**. Enabling both these options will prevent the buttons from becoming smaller or larger if you resize the main or floating toolbar.
- ◆ Whether to enclose **floating toolbar windows in frames**.
- ◆ **Number of pixels to leave between adjacent tracks** – i.e., between the bottom of one media item and the top of the one underneath it. A higher setting may make defining time selections easier.
- ◆ **Maximum number of lanes to be used when showing overlapping items**. A lower setting here (2 to 4) can help prevent screen clutter.

Envelope Settings include:

- ◆ Whether to use **filled automation envelopes**: enabled, this colors the area below the envelope and may make its shape easier for the eye to discern. Showing this over media items can be disabled.
- ◆ Whether to **show faint media peaks behind envelopes** in envelope lanes.
- ◆ Whether to **show horizontal grid lines** in automation lanes.

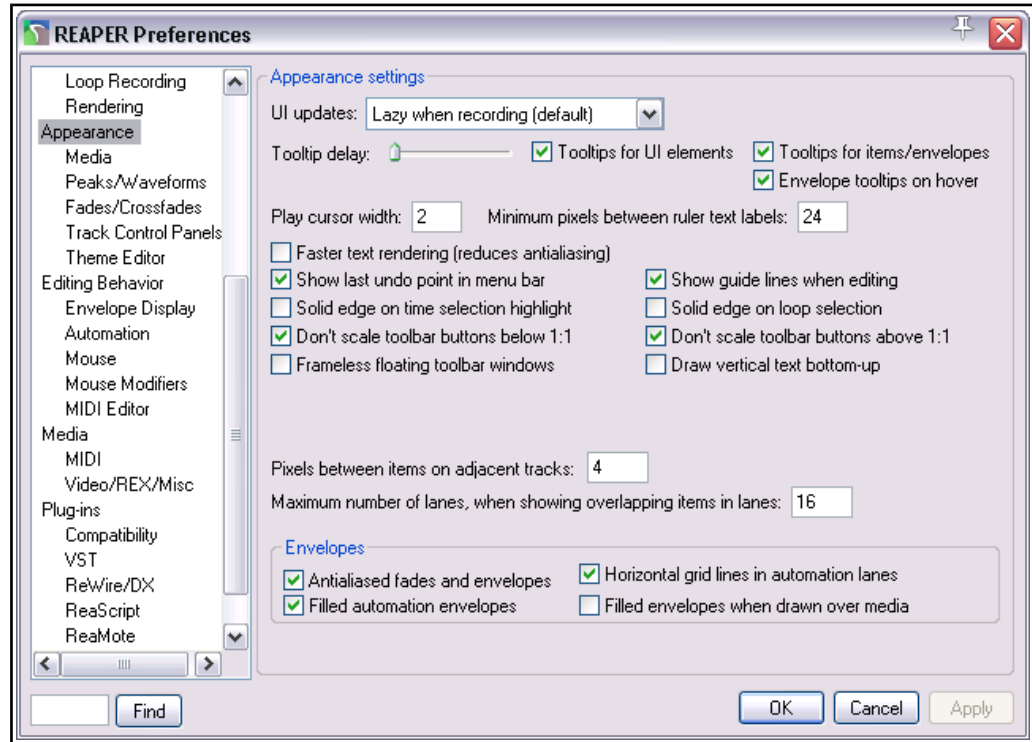

22.6.1 Appearance Media

For the most part these fall into two main groups – **Media item labels** and **Media item buttons**.

Media item labels: Whether to **display item take names** and/or **media item pitch/play rate** and/or **gain** (if set).

If showing any of these you can choose whether to **draw labels above the item rather than within the item**. If you enable this option you can also specify **Except when media item height is less than label height**. This will cause the label to be moved to inside the media item when the item lane height is less than the label height but also more than **Hide labels when media item take lane height is less than ...** setting.

You can also decide whether to use a **solid background for easier reading** and **whether to show labels when item edges are not visible**.

The second of these options will ensure that the labels remain visible as the project scrolls past the beginning of items. You can also determine how rate/pitch data is shown – e.g. normal, abbreviated, or numbers.

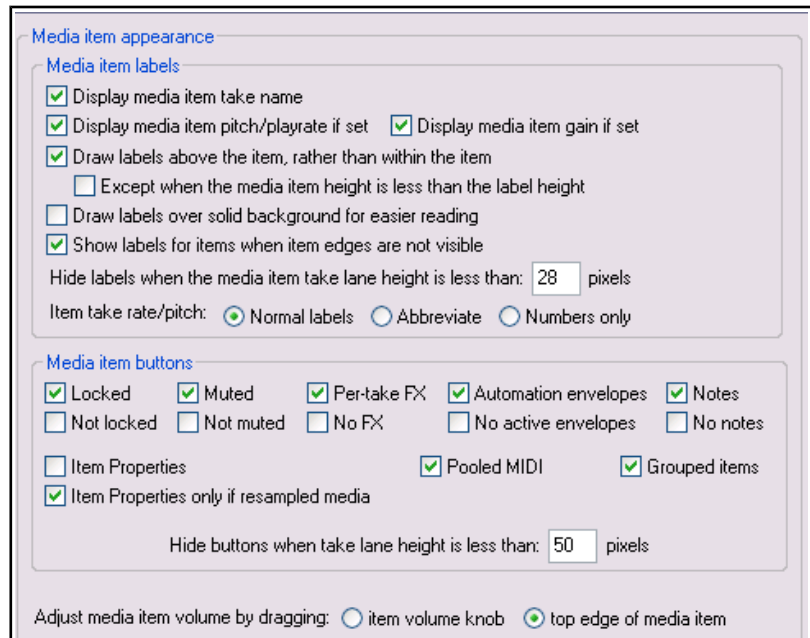

Media item buttons: Mostly these are paired – **Locked/Not locked, Muted/Not muted, Per take FX/No FX, Automation envelopes/No active envelopes, Notes/No notes, Item Properties, Pooled MIDI, Grouped items**. Choose which of these buttons you want displayed over or above your media items.

Adjust media item volume by dragging. You can choose either to use either a small rotary knob for this, or to use the top edge of the media items as a handle.

22.6.2 Appearance, Peaks/Waveforms

This page contains a number of options to determine the appearance of your peaks and waveforms.

You can specify whether you wish to **Display peaks for media items** and/or **Display peaks while recording**.

You can also choose not to show peaks for unselected tracks and/or muted/unsoloed tracks – **Only display peaks for tracks that are selected** and **Only display peaks for tracks that are soloed or not muted** will give you this.

Antialiasing is a technical issue. Google if you wish to learn more, but, in short, enabling antialiasing may give you a more accurate representation: disabling it may cause your peaks to be drawn/redrawn more quickly. The only difference that **edges** make is

cosmetic. Enable these options, for example, if you like your peaks bordered when using custom colors, disable them if you don't. *These options might be disabled by the color theme that you are using.*

You can opt to **Automatically scale MIDI notes** and/or **drum MIDI** to fit the item as displayed in arrange view.

There are also options to **Draw waveform zero lines above peaks/waveforms** and to **Fill waveforms to zero line**.

The option to **Scale peaks by pre-fx volume/pan envelopes** should be enabled if you want the peaks on your media items to be adjusted according to any pre FX envelope volume changes. Notice too that you can choose when closely zoomed in to your material to view the waveforms as Dots and lines, Filled samples, Outlined samples, Stepped samples or Smooth.

Enabling **Draw faint peaks in folder tracks** allows the output of a folder's child tracks to be displayed as waveforms in the folder's lane in arrange view.

Sample level waveform view determines how waveforms are displayed when zoomed in so close as to be able to identify individual samples – e.g., dots and lines, filled, outlined, stepped or smooth samples.

Custom Colors. You may have the options to **Tint media item waveform peaks** or **Tint item background** to any of **Track Color, Item Color** or **Take Color**. If more than one option is enabled, then the lowest level has precedence. That is, take color wins over item color which wins over track color. *Note that some themes may disable this group of options.*

You can also specify your required **tint strength** to be used for media item backgrounds, within a range of 0 to 4, where 2 is the system default.

Also in this section is the option **Automatically color any recording pass that adds takes to existing media items**. This can help to give a clearer picture when you are working with multiple takes.

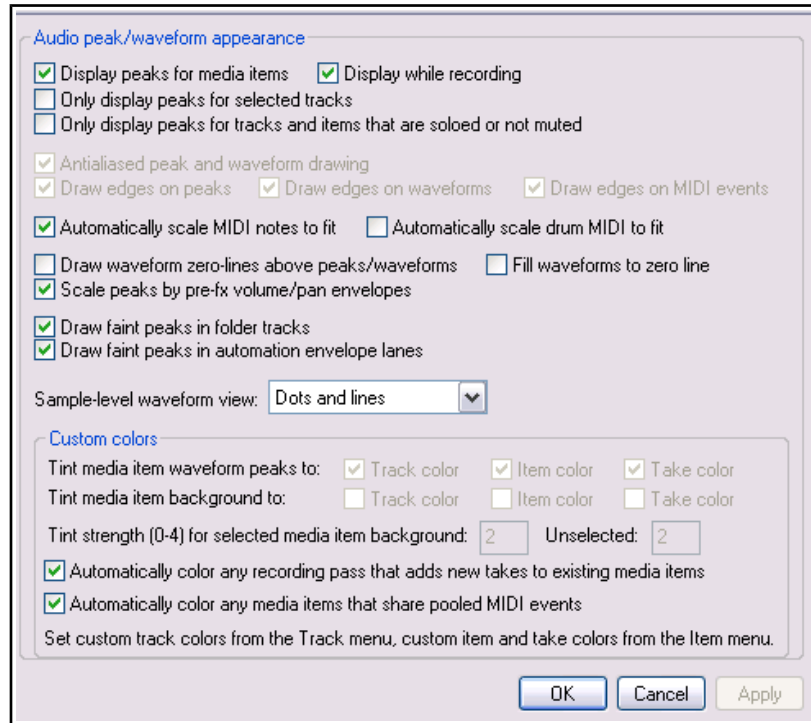

22.6.3 Appearance Fades/Crossfades

These options give you more precise control over media item fades and crossfades.

You can specify a minimum item **width** and/or **height** required before a fade can be edited.

You can **enable or disable mouse editing** of fade curves and/or fade starts and ends.

You can decide under which circumstances you do and do not want fade handles and **crossfade editing handles** to be displayed.

You can indicate whether or not you want **crossfade editor theme colors** to be used.

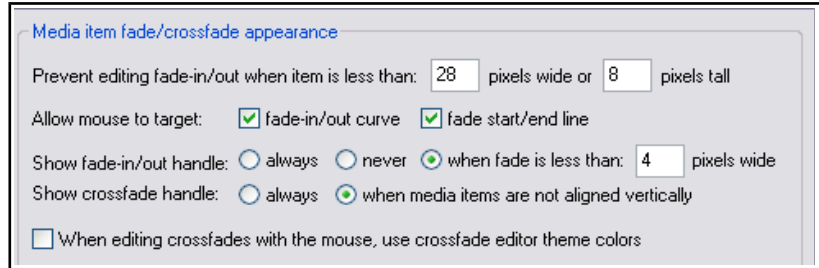

22.6.4 Appearance, Track Control Panels

Track control panel settings include:

- ◆ Whether to **use custom track colors** as a background color on track labels (in TCP and mixer) and to **tint track panels** (in TCP and mixer). *These options may be disabled by some color themes.*
- ◆ Whether to adjust the layout of **TCP controls** when track icons are used.
- ◆ Whether to use **track grouping indicators** (ribbons or lines), and if so which ones.

The next four items on this page set **Meter update frequency**, **Meter decay rate**, **Meter minimum value** and **Meter max value**.

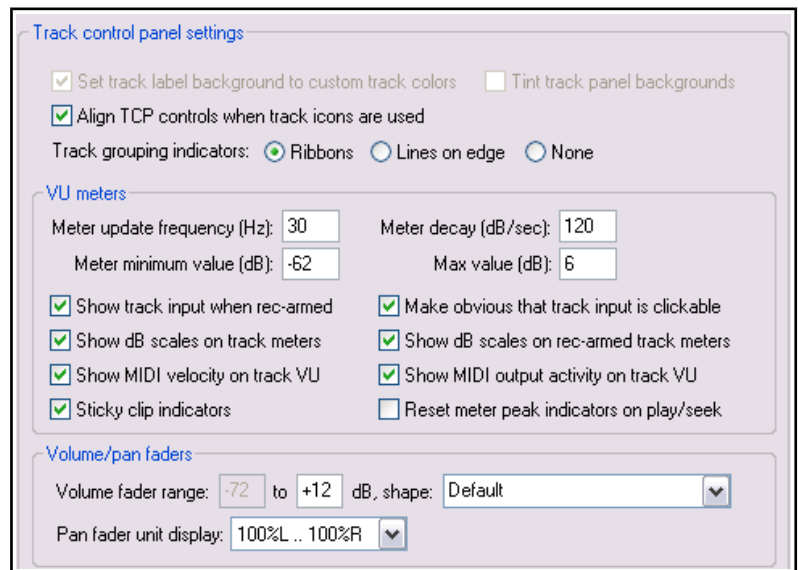

Unless you have good reason to change them, leave them at their system defaults.

There are other options which together define how your track meters will appear. Of special interest are: **Show dB scales on track meters** and **record armed track meters** if enabled will cause the dB scale to be marked, in numerals, on your VU meters.

Sticky clip indicators (enabled) ensure that peaks on the VU meter are marked with a bar for a few moments after they have passed.

Whether to show **MIDI velocity** and/or **MIDI output activity** on track VU meters.

Reset meter peak indicators on play seek. Disable this to keep the existing peak level displayed (until exceeded) when you re-commence playback.

The final options are **fader** options which can be used to restrict the adjustable **range** of your volume and/or pan faders. The top of the **volume** range can be set to 0dB or higher. There is also a drop-down box of **volume fader shape** options: for example, if you set this to 1.0 the fader becomes a log curve, so that linear movement produces a constant dB curve.

You can also specify whether **pan fader units** should be displayed as ranging from 100%L to 100%R or from -90 dB to +90 dB.

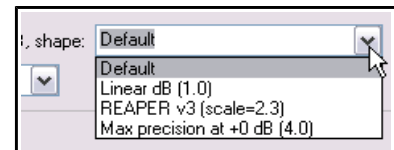

22.7 Editing Behavior Preferences

The **Editing Behavior** page of the **Options, Preferences** window (shown above) includes a number of areas in which you can specify default settings in a range of matters that will affect how you work when editing your REAPER projects. Here is a summary of some of the most useful options:

- ◆ Specify your **edit cursor behavior**, in particular which of the following actions should cause the edit cursor to be moved: Changing time selection, Pasting or inserting media, Stopping recording.
- ◆ Allow **shift click/control click** to override your move edit cursor assignments.
- ◆ By default link (or unlink) **time selection and loop points**.
- ◆ Enable or disable the ability for **loop points to be cleared by clicking on the ruler**, and/or **time selection to be cleared by clicking in arrange view**. For example, if you want to click on the ruler as a means of repositioning the edit cursor then you probably won't want loop points automatically cleared.
- ◆ Zoom preferences: **Vertical zoom** options are Track at center of view, Top visible track, Last selected track or Track under mouse cursor. **Horizontal zoom** options are Edit or play cursor, Edit cursor only, Centre of view or Mouse cursor. Choosing both mouse cursor options ensures that as you zoom whatever is under the mouse cursor will stay on screen.
- ◆ **Adjust tab sensitivity**, both percentage sensitivity and dB threshold. Other options are shown in the **Transient detection settings** dialog (right). You can also specify whether to **Tab thru MIDI notes** and/or **Treat media item edges as transients**.
- ◆ How REAPER should behave when locked items are included in a ripple editing selection. Options are **Locked items interrupt ripple** (ripple edit interrupted at first locked item but can be completed by repeating the action as often as required to choose which items are ripple edited), **Locked items interrupt ripple per-track** (similar but on a per track rather than per item basis), **Locked items unaffected by ripple** (these are edited normally but other items are ripple edited), or **Locked items are affected by ripple (lock ignored)** (all items in selection are ripple edited, including locked items).
- ◆ **Dual trim options** (for editing shared media item edges).
- ◆ Whether **crossfades** should **stay together** during fade edits.
- ◆ Whether to **automatically delete empty tracks** created when dragging items below last track.
- ◆ Whether dragging the **source start offset** of the active take should adjust the offset of all takes..
- ◆ Whether to **split/trim/delete all items at edit cursor** if splitting/trimming/deleting with no items selected. Disabling this will prevent, for example, all items being split if you press **S** with no item selected.

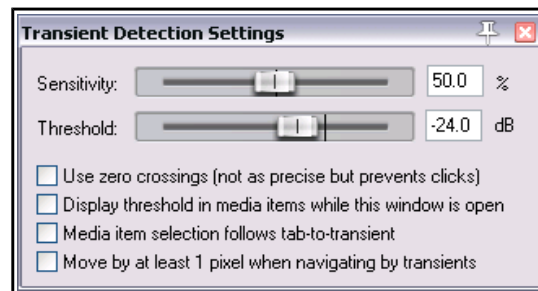
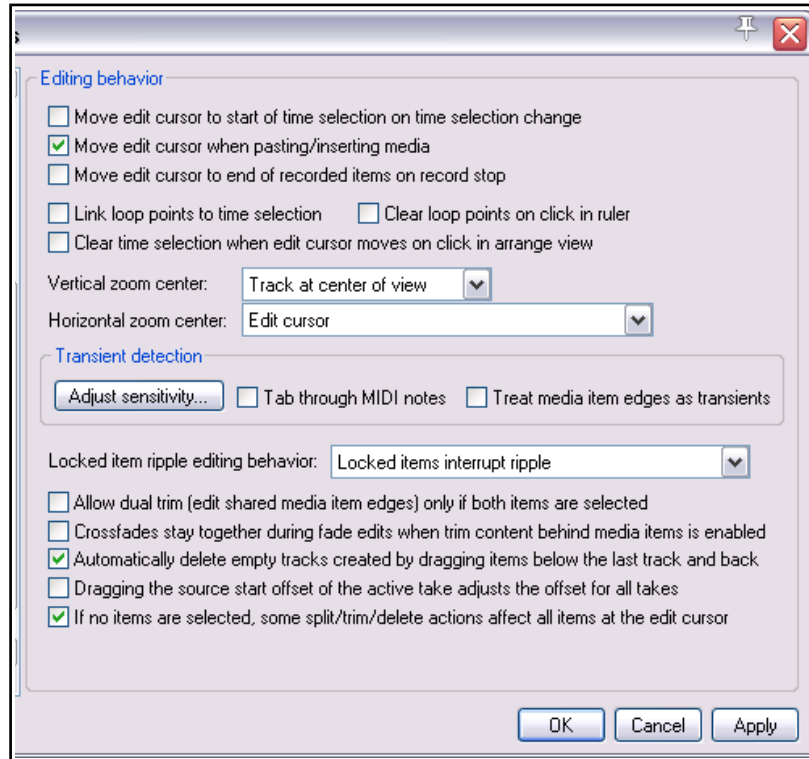

22.7.1 Editing Behavior, Envelope Display

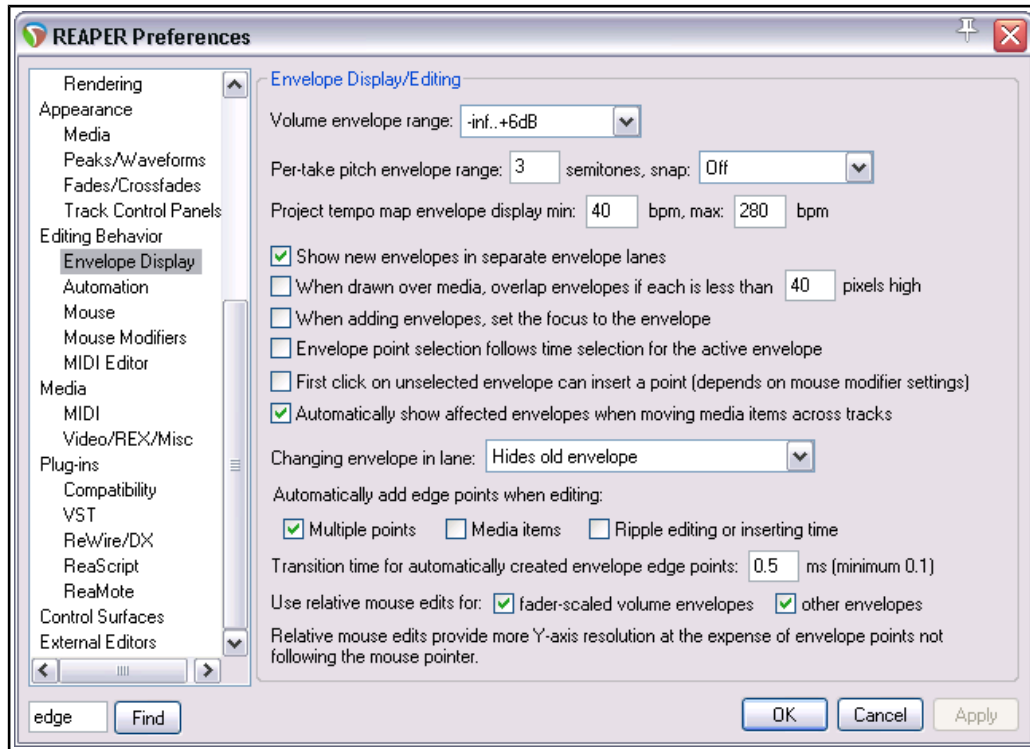

You can specify various diverse envelope editing options, including:

- ◆ Selecting the decibel **range** within which **volume** envelopes can be adjusted. Options range from **-inf...+0dB** up to **-inf...+24dB**.
- ◆ Specifying a semitone range for per take pitch envelopes, also whether or not to snap.
- ◆ Specifying a display range (beats per minute) for the master **project tempo map envelope**.
- ◆ Whether or not to **Show new envelopes in separate envelope lanes** by default.
- ◆ When drawn over media, overlap envelopes if each is less than x pixels high. Enabling this option may create a more cluttered visual effect, but it will allow more height for editing envelope points.
- ◆ Whether to **set the focus to new** envelopes as they are added. This automatically selects them for editing, etc.
- ◆ Whether **envelope points** are also selected with a **time selection**.
- ◆ Whether the first click on an unselected envelope will insert a point: check also mouse modifier settings.
- ◆ Whether to add a **transition point** on stopping playback after recording automation.
- ◆ Whether or not to **Automatically show affected envelopes when moving data across tracks**. Showing these can sometimes be visually confusing.
- ◆ Whether **Changing the envelope shown in any lane** should cause the envelope previously there to be hidden or moved to the media lane.
- ◆ Whether **edge points** (at start and end of time selection) are automatically added to envelopes when multiple points are edited, or when media items are edited, or when ripple editing, or when inserting time.
- ◆ You can also specify a required **transition time** for automatically created envelope edge points. A longer setting can create a smoother transition.
- ◆ Whether to use **relative mouse edits** for **fader scaled volume envelopes** only, or also for **other envelopes**. Note that relative mouse edits provide more Y-axis resolution, at the expense of the envelope points not following the mouse cursor.

22.7.2 Editing Behavior, Automation

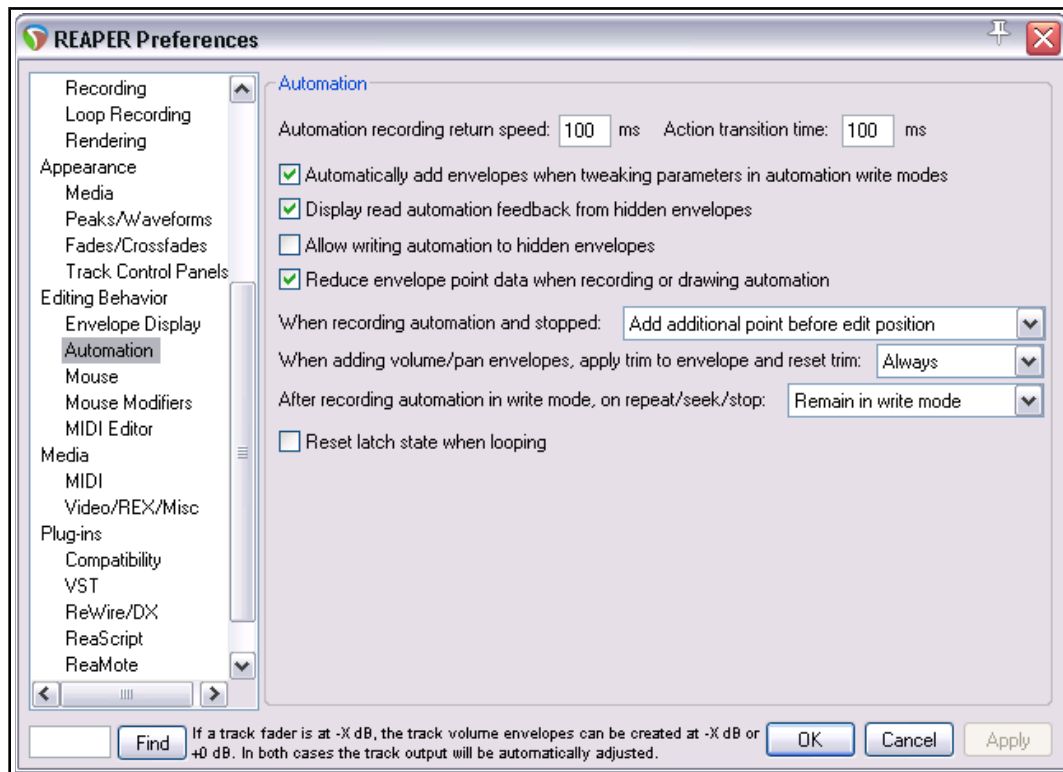

- ◆ Specify **automation recording return speed**: this is the time taken for the envelope to return to its previous value when using actions to write envelope changes.
- ◆ Specify **Automation transition time** to apply when using write current values for envelope writing actions.
- ◆ Whether to **Automatically add envelopes** when you adjust any parameters with write mode enabled. This makes creating envelopes fast and snappy, but means that with write mode enabled you will not be able to adjust any parameters without creating envelopes for them.
- ◆ Whether to **display read automation feedback from hidden envelopes**. For example, if you have a volume envelope that is hidden, enabling this option will allow the volume fader to automatically move with changes in volume, even though the envelope is hidden, providing read mode is enabled.
- ◆ In **Write** mode, whether to **allow writing automation to hidden envelopes**. Only enable this if you are sure about what you are doing: otherwise you risk making accidental changes to envelopes.
- ◆ Whether to **reduce envelope point data** when recording or drawing automation. Not enabling this can lead to more points being created than you might like.
- ◆ When recording automation stops, whether to **add an additional point before the edit position, before and after** the edit position, or **not at all**.
- ◆ **When pan/volume envelopes are added, whether trim is reset** when the envelope is drawn. Options are Always, In read/write mode only, or Never. Setting this to Never may make the manual editing of such envelopes easier (by leaving you plenty of room both above and below the envelope).
- ◆ **After recording automation in write mode whether to automatically switch to one of the other modes**. The trim/read option is handy if you are inclined to forget to do this manually!
- ◆ Whether where there are one or more **latch mode envelopes**, these should be reset to their initial states when looping occurs during playback.

22.7.3 Editing Behavior, Mouse Preferences

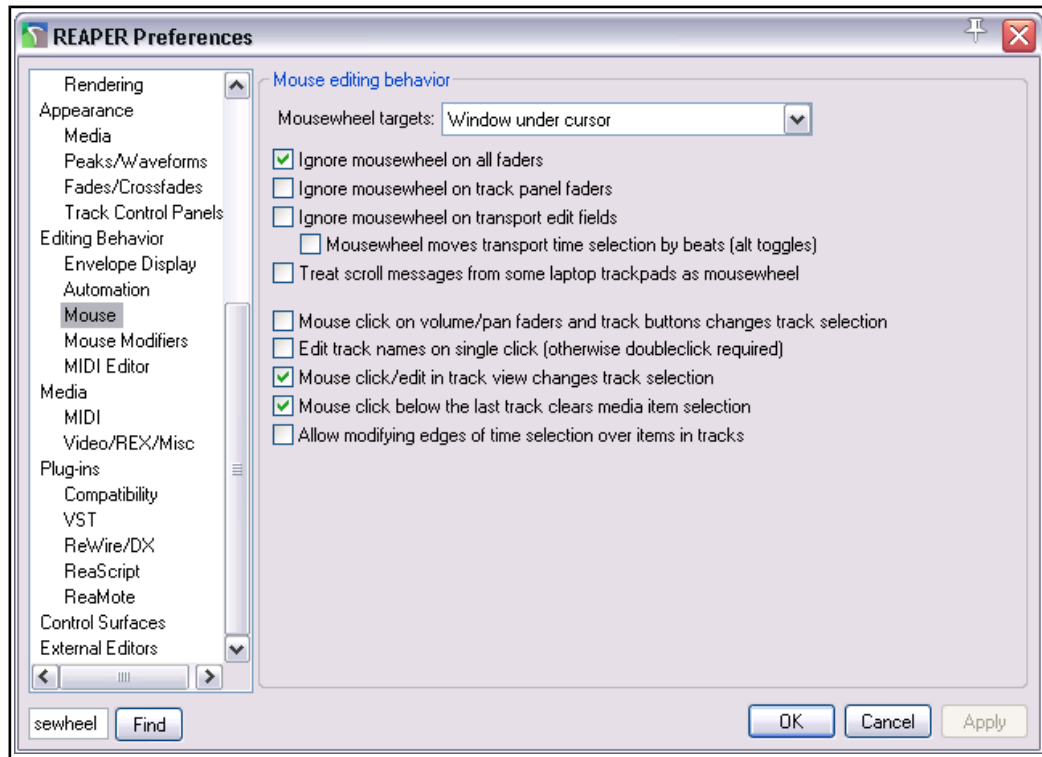

The **Mouse** page of the **Options, Preferences, Editing Behavior** window (above) is used to determine specify how you would like your mouse to behave in REAPER. Here is a summary of some useful options:

- ◆ **Mousewheel targets:** whether your mousewheel acts on the window currently underneath the mouse or on the last window to have focus. This, for example, allows you to use the mousewheel to adjust the parameters of an open FX window without first having to click on the window to give it focus. Focus can remain with your mixer, or arrange view, or wherever you were before. For example, **Esc** would then clear the current time selection rather than close the FX window.
- ◆ Whether to **Ignore the mousewheel on all faders**. Disable this or either of the next two options if you wish to use your mousewheel to adjust faders on the TCP and/or the transport bar and/or FX controls.
- ◆ Whether to **Ignore the mousewheel on track panel faders**.
- ◆ Whether to **Ignore the mousewheel over transport edit fields**. If disabled, you can edit text fields such as BPM and play rate just by scrolling your mousewheel over the field. There is also an option to use the mousewheel to **adjust transport time by beats**.
- ◆ Whether to treat scrolling a **laptop trackpad** as being like using a mousewheel.
- ◆ Whether **Mouse click on track fader or button** causes that track to become the currently selected track. Disabling this allows you to adjust track faders, etc. without changing the track selection.
- ◆ Whether to require a **single** click or a **double** click when **editing track names**.
- ◆ Whether **Mouse click/edit in track view changes the track selection**. Enabling this will ensure that track selection will follow media item selection.
- ◆ Whether to **Allow modifying edges of time selection over items in tracks**. Enabling this allows you to click and drag over a track (or between tracks) to adjust the start or end of a time selection without affecting item selection.
- ◆ In addition, for **OS X** users on a Mac, there is an option **Ctrl left click emulates right click**. However, it is a better practice to use your System Preferences to enable right-clicking.

Mouse Modifiers: The topic of **Mouse Modifier** preferences is covered extensively in Chapter 15 and elsewhere.

22.7.4 Editing Preferences, MIDI Editor

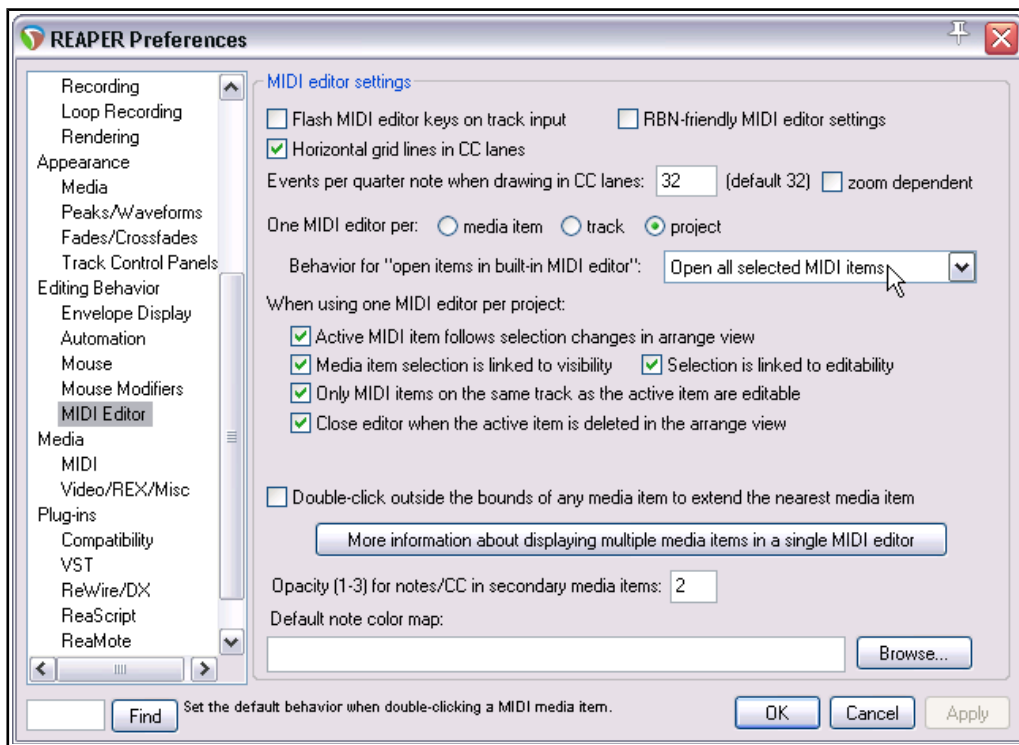

- ◆ **Flash MIDI editor keys on track input:** if enabled, causes a brief color flash to be displayed on the MIDI editor keyboard when the track receives MIDI note-on input.
- ◆ **RBN friendly MIDI editor settings:** allows REAPER's MIDI editor to behave in a way compatible with RBN (RockBand) MIDI authoring. For example, lyric events will be attached only to playable notes.
- ◆ **Horizontal grid lines in CC lanes:** toggles the option to show horizontal grid lines on and off.
- ◆ **Events per quarter note when drawing in CC lanes.** Specific event density or zoom dependent.
- ◆ **One MIDI editor per ...** Select whether a separate MIDI editor instance is required for each item, or for each track, or one instance for the entire project. Depending on your choice you may have other options.
- ◆ **Default Behavior for open items in built-in MIDI editor:**
If **One MIDI editor per project** is selected, specify whether to open **clicked item only**, **all selected MIDI items**, **all MIDI items on the same track** or **all MIDI items in the project**.
You also have four more toggle options. These are:
 - ◆ **Active MIDI item follows selection change in arrange view.** This option is also available if **One MIDI editor per track** is selected.
 - ◆ Whether **Media item selection is linked to visibility** and/or **Selection is linked to editability**.
 - ◆ Whether **Only MIDI items on same track as the active items are editable**.
 - ◆ Whether to **Close MIDI editor when the active item is deleted in arrange view**.
- ◆ **Double-click behavior:** Whether double-clicking a note should switch the active media item and, if so, whether this should occur only when the media item is on the same track and/or already editable.
- ◆ Whether **double-clicking outside the bounds of a media item should extend that media item**.
- ◆ Option to display a panel showing more information about multiple media items in a single MIDI editor.
- ◆ Set **Opacity for notes/CC in inactive media items**. The higher the number, the darker these notes will appear.
- ◆ **Default note color map:** allows you to specify your own default note color map.

22.8 Media Preferences

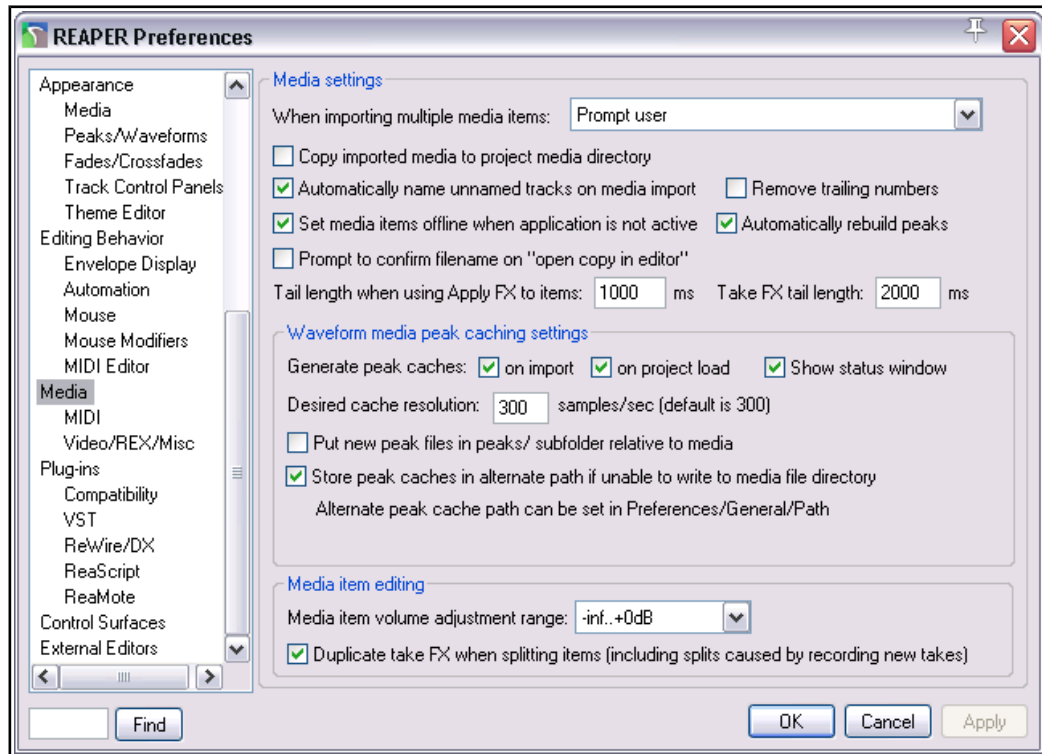

The **Media** page of the **Options, Preferences** window lets you customize your Media settings. Here is a summary of some of the options that you might find most useful.

Item	Purpose
Media Settings	<p>When inserting multiple media items: You can choose whether the default behavior should be to insert as separate tracks, to insert sequentially in a single track, for REAPER to determine which appears the more appropriate, or whether you wish to be prompted each time.</p> <p>Copy inserted media items to project media directory: When enabled, this ensures that a copy of any media items inserted into a project will be made and stored in the project directory. This helps you to keep together all those files that belong together.</p> <p>Whether to use the media file name to Automatically name unnamed tracks on media import.</p>
Waveform media peak cache settings	<p>Generate peak caches: You can determine the circumstances in which you want peak caches to be generated.</p> <p>Desired cache resolution: Determines the precision used for media peaks.</p> <p>Option to Put new peak files in peaks/subfolders relative to media.</p> <p>Options to Store peak caches in alternate path.</p>
Media item editing settings	<p>Media item volume adjustment range: Sets this to -inf to 0 dB or -inf to +6 dB.</p> <p>Duplicate take FX when splitting: Determines whether any existing FX in an item's FX chain are automatically copied to new items that are created when the original item is split.</p>

22.8.1 Media, MIDI Preferences

MIDI octave name display offset: by default, middle C (MIDI note 60) is labelled C4. An offset of, say, -1 would cause this to become C3, and so on.

Allow trim of MIDI items when splitting will add a note-off message for any note that spans the split point when a MIDI item is split.

Pool MIDI source data is discussed and explained in Chapter 13. You can disable this if you prefer.

Items created or imported as REAPER **MIDI items** (rather than .MID files) can be better edited in the MIDI Editor. **.MID files** are more portable between apps. You can, if you wish, create them as MIDI items and later export to file.

Ticks per quarter note sets data resolution for new MIDI items. The default setting of 960 equates to 2 ticks per microsecond at 120 bpm.

You can specify when **Importing multichannel MIDI files** whether to do so as a series of single channel tracks, as one multichannel track, or always to prompt, and whether to **Always prompt to import tempo from MIDI files with simple tempo maps**.

Snap behavior can be set so that time signature changes in imported MIDI files are set to whole bars, and that tempo changes in imported MIDI files are set to whole beats.

MIDI text events can be exported in Latin-1, UTF-8 or ASCII (7 bit) format

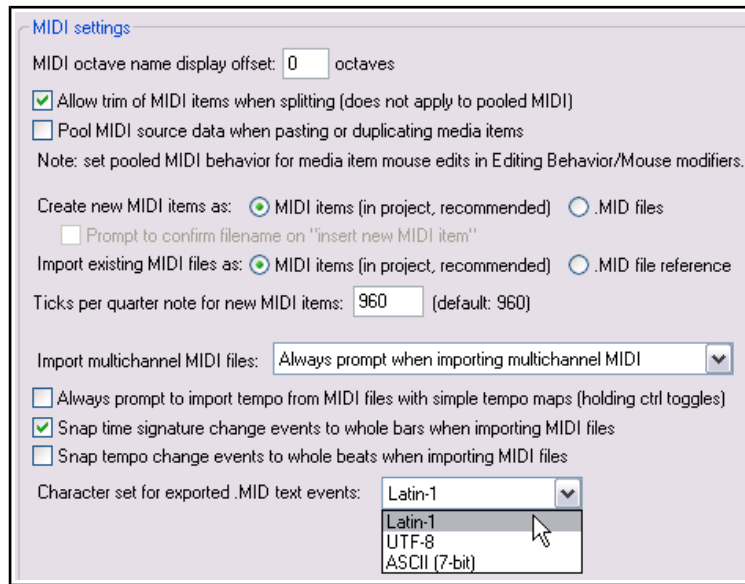

22.8.2 Media, Video/REX/Misc Preferences

The **Video** preferences options are explained in Chapter 20. Your optimum settings will depend largely on which platform you are using (e.g. Windows 7) as well as your choice of video systems and format.

The **REX** options include how you wish to **Import REX file contents**. This can be as beat slices that will adjust to tempo changes, or as single loopable media items, or to always prompt.

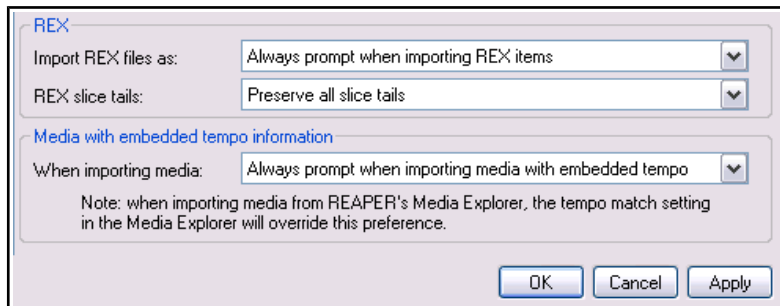

You can specify whether **REX slice tails** should be preserved, all chopped, all chopped except the final slice, or only the final slice chopped.

Finally, you have an option for determining how **imported media with embedded tempo** is to be handled. You can always adjust the media to project tempo, import it at its own tempo, or always prompt.

22.9 Plug-ins Preferences

Your two **Automatically resize FX windows** options, if enabled, will ensure as you browse thru a track's FX chain that the FX window is automatically resized to suit the currently selected FX.

You can specify if **floated FX windows** should automatically be placed on top, if **newly created FX windows** should be floated, and if windows should be automatically opened for FX added from the TCP and MCP context menus.

You can specify whether or not to **auto-dock newly created FX windows** and whether you want the **Add FX** window opened automatically when you open an empty FX chain for a track or media item.

22 - REAPER's Preferences and Other Settings

The two **Auto-position** options if enabled will ensure that REAPER will try to find a good position for floated FX and/or FX chain windows rather than cascade them on top of others.

If you enable the option to **Only allow one FX chain window open at a time** you may also specify whether you want the open window shown to change when you change track selection (**Open FX window on track selection change**) and whether this is to happen **only if an FX window is open**.

You can also opt to have **track FX added to the item FX button right click menu**. This enables you to open these FX directly from this button.

You can also specify how many FX are to be shown on the context menu **Recently added list** and whether **current track FX** should be shown on the FX button context menu.

Finally, you can apply an **FX filter string**

that will be applied to all views when using the FX browser (e.g. *NOT sonalksis* if you do not want these plug-ins to be shown). This will be in addition to any filter you apply in the FX browser itself.

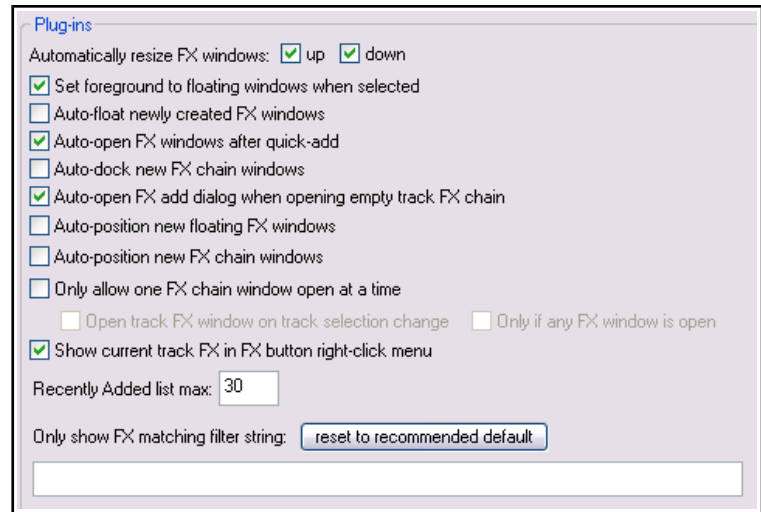

22.9.1 Plug-ins, Compatibility

The main options here concerns VST bridging and firewalling. These are features designed to help protect REAPER from crashing as a result of an unstable plug-in being used. The default option is for **automatic bridging** to be applied when the program deems it necessary, but you can change this to In separate plug-in process, In dedicated process per plug-in, or Disable bridging. To follow discussions on what these options mean in practice in different situations you should consult the REAPER forums.

22.9.2 Plug-ins, VST

You have already seen (in Chapter 1) how to tell REAPER to locate and enable your VST plugins. The **VST Compatibility** section offers a number of further options for controlling the behavior of your VST plug-ins.

You can determine how VST parameter automation notifications should be handled. Options are **Ignore when window not open**, **Ignore when not from UI thread**, **Ignore all notifications**, and **Process all notifications**.

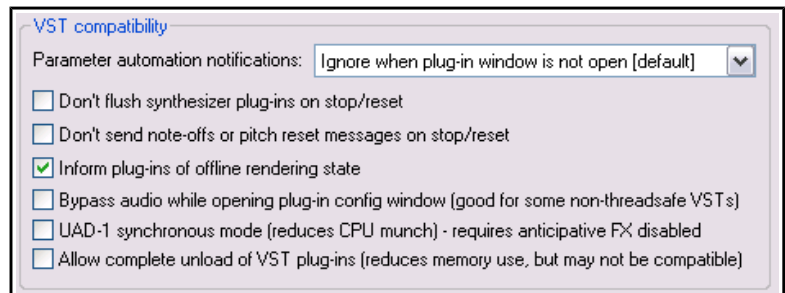

Other preferences in this category are likely to depend on which plug-ins you are using. Individual plug-ins vary so much that it would be virtually impossible to give very much meaningful general advice here. You may need to experiment to get the best results. Hover your mouse over any option to see a Help message at the bottom of the window. For further help, be prepared to ask questions on the REAPER forum.

Especially worth noting (for MIDI users) are the options **Don't flush synthesizer plug-ins on stop/reset** and **Don't send note-offs or pitch reset messages on stop/reset**.

22.9.3 Plug-ins, ReWire/DX

ReWire options include whether to show any already opened ReWire aware apps or devices as available FX in the FX window and whether to automatically open the native control panel for any ReWire application selected. There is an option to **Check when starting REAPER for any device already open** that is capable of acting as a ReWire master, and if so to open REAPER in slave mode. There is also a dialog box where you can specify your **ReWire slave project settings**.

Direct-X (DX) plug-ins are by default **Enabled**. You can **Scan for new DX plug-ins** manually or specify **Scan for DX plug-ins** on startup.

22.9.4 Plug-ins, ReaScript

This topic is discussed in Chapter 24.

22.9.5 Plug-ins, ReaMote

This topic is discussed briefly in Chapter 24.

22.10 Custom UI Tweaks

The **General** page of the **Options, Preferences** window includes an **Advanced UI/System tweaks** button which enables you to further customize REAPER's on-screen appearance. Clicking on this button displays a number of options including:

Custom Splash Screen – A .BMP or .PNG file.

Use large window frames for windows.

Scale UI Elements (such as buttons on toolbars). This can be useful if you are working with a very high screen resolution.

Allow track envelope/routing windows to stay open. Select this option if you want track routing and envelope windows not to be closed automatically when they use focus.

Advanced system and multiprocessing tweaks. These options help determine the way REAPER behaves on a system with two or more processors. They are considered experimental, should be used with caution, and may require a restart of REAPER.

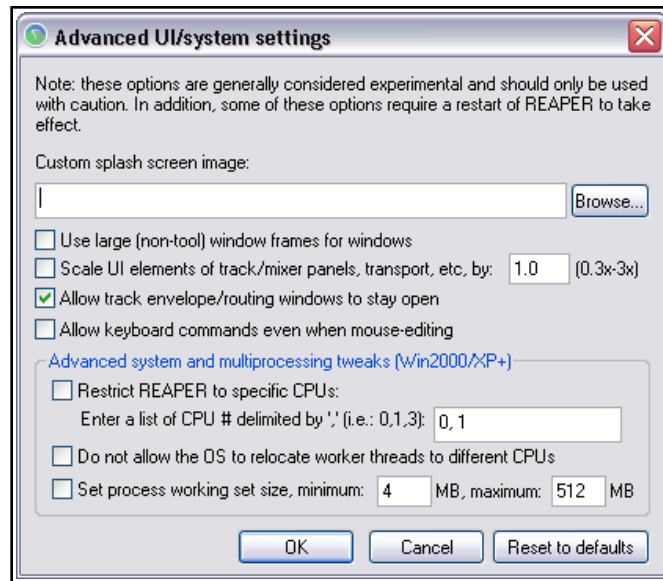

22.11 Project and File Management

You have already seen that when you save a REAPER project file you have the option to create a subdirectory for that project, and to copy, move and store all of the project's media files into that directory. Making use of this option will make it easier for you to keep track of your work.

However, you will most likely find that as a project evolves, it will accumulate any number of media items, such as rejected tracks and overdubs, or deleted items that are no longer required. You can easily remove these unwanted items, using the command **File, Clean Current Project Directory**.

The location of the current project folder is displayed just below the Project Directory Cleanup title bar. If you wish, you can click on the **Explore** button to explore the folder's entire contents. Notice, however, that all the files present in the project directory but not belonging to the current project are listed in the Project Directory Cleanup window.

To select any one file, just click on its name. To build a selection, hold the **Ctrl** key while you click on each required file name. To select all files in the list, click first on the first file name then, holding the **Shift** key, click on the last name in the list. You then have the option to either delete these files permanently from your hard drive, or to send them to the Windows Recycle Bin (as shown here).

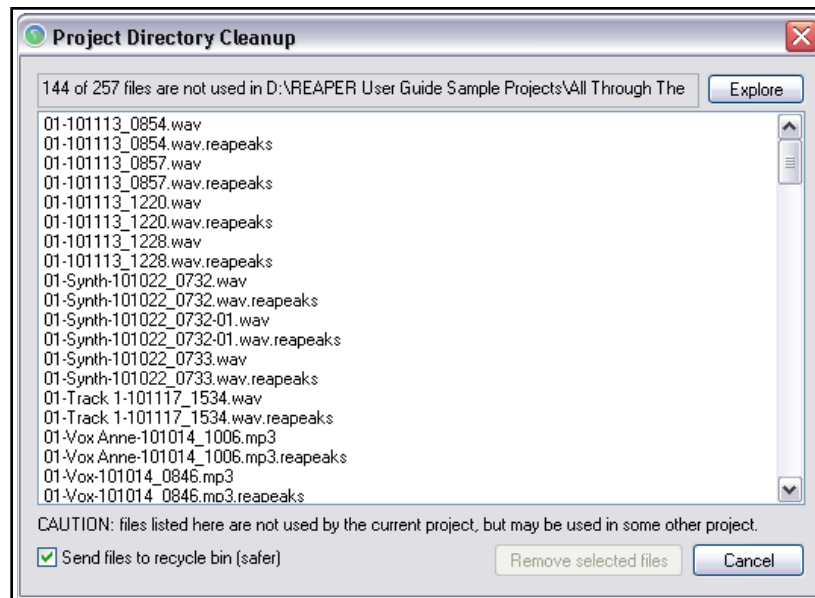

22 - REAPER's Preferences and Other Settings

After making your selection, click on the **Remove Selected Files** button to remove them.

Don't forget also to **backup** your work regularly, to a flash drive, external hard disk, CD or DVD, or more than one of these. The easiest way to back projects up is to simply use the Windows file management system.

22.12 Customizing the Performance Meter

You can customize the information shown on the performance meter, making your selections from its context menu (see right). Amongst the items that can be displayed or hidden are:

CPU Graph	CPU Use	Disk Use
RAM Use	Free System RAM	FX CPU use

The Performance Meter track list can be sorted by clicking on any column heading,

If ReaMote has been installed and enabled (see Chapter 24), the Performance Meter will display an additional ReaMote column.

The Performance Meter can also be docked or undocked.

Note: The RT ("Real Time") CPU meter measures the amount of CPU time used by the audio thread servicing the sound device. Since it is measuring a single thread, it reflects only the CPU time used by one core, and gives you an indication of how much leeway you have in processing. If you have anticipative FX enabled (and few tracks record armed), RT CPU will generally be pretty low, as most things should be done asynchronously, allowing the real time thread to quickly put things together.

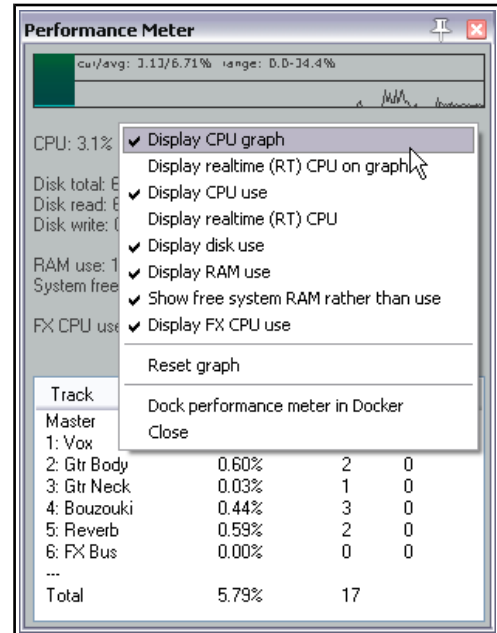

22.13 Customizing Undo History Behavior

As already discussed (Chapter 2), REAPER's **General preferences** enable you to customize your Undo History behavior. Options include:

- Add undo points for item/track/envelope selection and/or cursor movements.
- Save Undo History with project files.
- Allow load of Undo History.
- Store multiple redo paths where possible.

These features can be selected from the **Undo Settings** section of the **Options, Preferences, General** screen.

If you enable the option to **Store multiple redo paths where possible** then during your current work session, any time you use the Undo History window to go back to an earlier point, then any actions you take from that point on will be stored as an alternate set of actions to the set of actions already stored. REAPER will remember both paths independently of each other. Moreover, every time you return to that point, another new undo path will be created.

An example is shown on the right. The highlighted action **Add FX to Chain** is flagged with **(*2)**. This means that in addition to the original set of actions, two more undo history paths exist where twice we have gone back to that point. By right-clicking where shown, we are able to choose which undo state we wish to load, this enabling us to restore those commands and actions.

If you also enable the options to **Save undo history with project files** and **Allow load of undo history**, then this undo history will still be available to you next time you use this project file, even if you have since closed REAPER and shut down your computer.

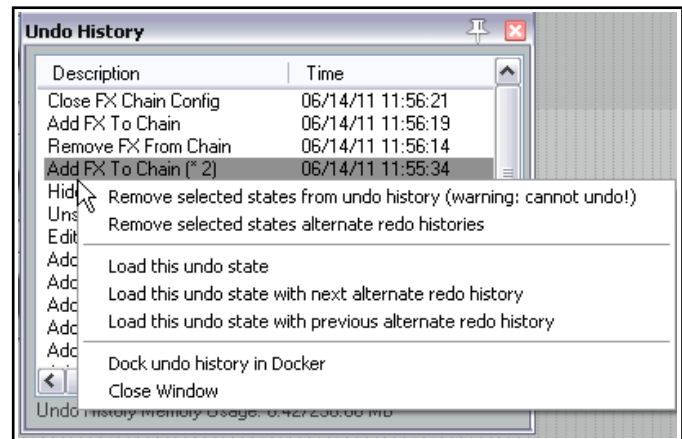

22.14 Reset REAPER Default Settings

REAPER's default settings and configuration can be restored from the Windows Start menu.

Up and Running: A REAPER User Guide v 5.24

1. Click on the **Start** button then **All Programs**.
2. Click on **REAPER** then on **REAPER (reset configuration to factory defaults)**.

Before doing this, it can be wise to back up or export elements such as custom toolbars and menus, custom actions and shortcuts, mouse modifiers, color theme changes, etc. in case you later want to restore them.

22.15 Some Other REAPER Options

The following are some of the items that appear on the **Options** menu. Many of these have been covered elsewhere in this User Guide. In many cases the function of these commands is self-explanatory:

Record modes: See chapter 3

Auto-crossfade media items when editing: on/off toggle.

Trim content behind media items when editing: on/off toggle.

Show all takes in lanes: on/off toggle.

Take lane behavior: Show or hide empty take lanes. Allow/disallow selecting of empty take lanes.

Show overlapping media items in lanes: on/off toggle.

Ripple editing: three way toggle – off, per track or all tracks.

Item grouping enabled: on/off toggle.

Snap/Grid: enable snapping toggle, show grid toggle, access snap/grid settings.

Locking: on/off toggle, access lock settings.

Metronome/preroll: on/off toggle, access metronome settings.

Envelope points: sub menu of options also available by right-clicking on envelope button.

Loop points linked to time selection: on/off toggle.

Automatically scroll view during playback: on/off toggle.

Continuous scrolling on/off toggle. Enabled, locks play cursor stationary in middle of screen during playback and scrolls media items.

Smooth seeking: on/off toggle.

External Timecode Synchronisation: toggle synchronisation on/off, access to synchronisation settings.

Show REAPER resource path ... : shows location of REAPER resource files in Windows Explorer or OS X Finder type window.

Customize menus/toolbars...: opens customize menu/toolbars window.

Themes: displays sub-menu of installed color themes.

Layouts: displays sub-menu of track and mixer layouts available from the current theme.

Preferences: opens Preferences window.

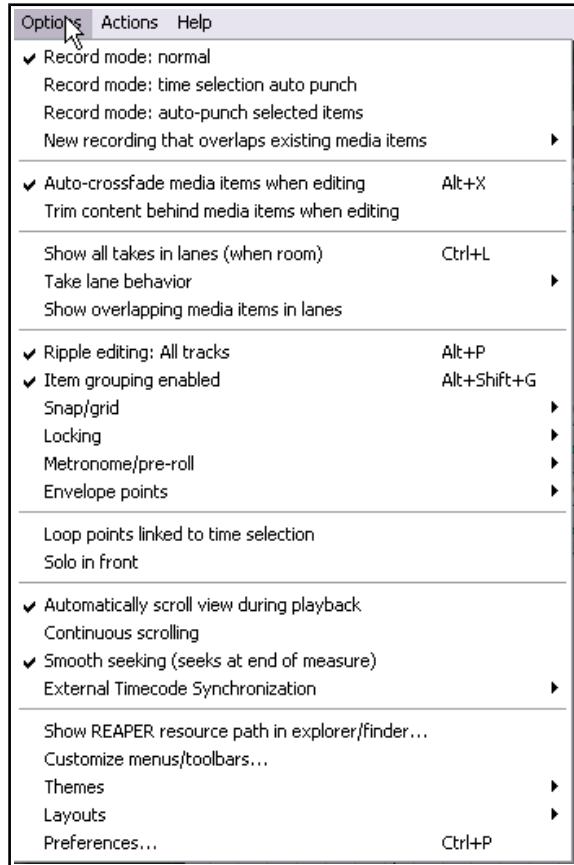

23 Main Right-Click Context Menus Summary

You have seen how important right-click context menus are in REAPER. Right click just about anywhere and a menu will pop up. That menu will depend on exactly where the mouse is pointing when you click the right button. Point and right click over a track name or number in the track control panel or mixer and the track control menu will be displayed. Right click over a track's mute button and you'll get a menu of various mute options. Right click over a media item and you'll get a menu of command and actions used for managing, editing or processing media items.

Many of these have already been explained in the preceding chapters. There isn't room here to review every one of REAPER's right click context menus in detail, but in this section you'll find a summary of the major ones.

23.1 The Track Control Panel Context Menu

This menu is accessed by right-clicking over a track name or number, or over any part of its control panel that does not show a track control.

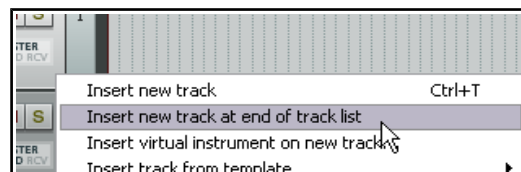

Command	Comments
Insert new track	Inserts a new track after the currently selected track.
Insert new track at end of track list	Inserts new track after last track in project.
Insert virtual instrument on new track ...	Inserts and builds VSTi/DXi on new track.
Insert track from template	Inserts a new track based on any existing template. Offers you a submenu of templates.
Save tracks as track template ...	Saves all tracks in current selection as a single track template.
Remove tracks	Removes (deletes) any track or tracks currently selected.
Duplicate tracks	Creates a duplicate of any track or tracks currently selected, immediately below the original track.
Render/freeze tracks	Offers a sub-menu from which to choose an option for stem rendering or freezing/unfreezing the current track selection.
MIDI track controls	Offers a sub-menu of: Show MIDI track control panel Link track volume/pan to all MIDI channels Link track volume/pan to [specified] MIDI channel Do not link track volume/pan to MIDI
Lock track controls	Toggles lock status of all parameter controls on selected track(s).
Enable track free item positioning	Toggles free item positioning mode on and off for selected tracks.
Automatic record-arm when track selected	Toggles automatic record arm status for current track selection.
Multichannel track metering	Toggles display of out put of all channels in track meter if the track consists of more than 2 channels.
Track Manager (show/hide tracks)	Toggles display of Track Manager window.
Track color	Displays a sub-menu of track coloring options.
Track icon	Displays a sub menu to show or hide icons for selected tracks.
Set track timebase	Sets the timebase of selected tracks to project timebase (default), time, beats (position, length rate) or beats (position only).
Set track automation mode	Displays a sub-menu to set automation mode for selected tracks to Trim/Read, Read, Touch, Latch or Write.
Track performance options	Displays a sub-menu to enable/disable anticipative FX processing and/or media buffering and/or track metering for selected tracks.
Set track layout	Displays a sub-menu to choose a custom TCP and/or MCP layout for selected tracks.
Envelopes	Displays envelopes management sub-menu.
Track grouping parameters ...	Opens Grouping window for selected tracks.
Track grouping enabled	Enables/disables track grouping for selected tracks.

Up and Running: A REAPER User Guide v 5.24

23.2 The Empty Track List Area Context Menu

This menu is accessed by right-clicking anywhere in the empty area below the track list in the track pane area.

Command	Comments
Insert new track	Inserts a new track below currently selected track.
Insert multiple tracks...	Allows you to insert more than one track at a time.
Insert virtual instrument on new track...	Inserts a new track for a VSTi along with multichannel outputs if required.
Insert track from template	Inserts new track from any template you select.
Show master track	Toggles on and off the display of the master track.

23.3 The Timeline and Ruler Context Menu

This menu is accessed by right clicking the mouse in any of the following areas:

- Over the Ruler or Timeline displayed above the first track (see right).
- Over the blank area above the ruler.
- Over the empty background area in the Track View area.



An explanation of the menu follows.

Command	Comments
Remove selection	Deselects current time selection. Removing the selection does not cause any media items to be deleted.
Zoom selection	Zoom to current time selection.
Set selection to items	Makes the selection along the timeline the same as the portion of the timeline covered by the currently selected item or items.
Extend selection to next transient in items	Extends the area of the selection to the next transient.
Insert marker ...	Inserts marker and opens the Add Marker dialog box at the current cursor position.
Create region from selection	Creates a region from the current selection.
Insert tempo/time signature marker...	Inserts a time signature marker at the current cursor position.
Remove all markers from time selection	Removes all markers from the currently selected area.
Set project tempo from time selection	Creates project tempo based on time selection (three options).
Create measure from time selection	Creates a new measure from the current time selection, either by tempo or with a new time selection..
Crop project to selection	Crops all media items in the project to the current time selection.
Insert empty space in selection	Inserts an empty space equal to the currently selected area into all tracks in the current project.
Remove contents of selection (moving later items)	Effectively deletes the currently selected area from the project, moving all later items up to fill the gap, whether or not ripple editing has been turned on.
Paste	Pastes any previously cut or copied item into the currently selected track at the current cursor position.
Split items at cursor	Splits currently selected item or items at the current cursor position. If no item is selected, splits all items.
Split items at time selection	Splits currently selected item or items at the start and end of the current loop selection. If no item is selected, splits all items.
Select All	Selects all media items.
Copy selected area of items	Copies the selected area of selected items to the clipboard.
Copy loop of selected area of items	Copies the selected area as a loop.

23 - Main Right-Click Context Menus Summary

Command	Comments
Minutes:Seconds Measures.Beats/Minutes:Seconds Measures.Beats Measures.Beats (minimal) Measures.Beats (minimal)/Minutes:Seconds Seconds Samples Hours:Minutes:Seconds:Frames Frames	These six options are mutually exclusive. Select any one to set the unit of measurement used for ruler display.

23.4 The Media Items Context Menu

This menu is accessed by right-clicking over any media item. If a number of media items have been selected, the command selected from this menu will be applied to all those items. An explanation of this menu appears below.

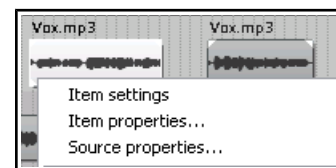

Command	Comments
Item settings	Opens the Item settings sub-menu (see below).
Item properties...	Opens Item Properties dialog box.
Source properties...	Opens Source Properties dialog box.
Group	Opens Group sub-menu, to group or ungroup selected items,
Take	Opens Take sub-menu for takes management (see below).
Comps	Opens Comps sub-menu for comps management (see below).
Item and take colors	Opens color management sub-menu (see below).
Item processing	Opens Item processing sub-menu (see below).
Stretch markers	Add, snap or remove stretch markers.
Open items in editor	Opens a submenu whose commands are used to open the selected item/items (or copies of these items) with the editor specified under Options, Preferences, External Editors).
Open in built in MIDI editor	Opens selected MIDI item with REAPER's MIDI editor": several options.
Apply track FX to items as new take Apply track FX to items as new take (mono output) Apply track FX to items as new take (multichannel output) Apply track FX to items as new take (MIDI Output)	This group of commands allows you to process selected items as new stereo takes, mono takes, multichannel output or MIDI takes.
Render items as new take	Renders selected items with any FX as new takes.
Reverse items as new take	Reverses selected media item or items as a new take.
Glue items Glue items within time selection	Joins selected media items into one new item.
Move items to new subproject	Moves selected items into a new subproject file.
Copy items Copy selected area of items Copy loop of selected area of items	This group of commands offers three options for copying the current selection to the clipboard.
Cut items Cut selected area of items	This group of commands offers two options for cutting the current selection to the clipboard.
Paste	Pastes content of the clipboards to the currently selected track at the current cursor position.
Remove items	Deletes selected media items from the project.
Trim items to selected area	Trims media items to the currently selected area.

Up and Running: A REAPER User Guide v 5.24

Command	Comments
Nudge/set items...	Opens the Nudge/Set Items dialog box.
Split items at cursor	Splits currently selected items at current cursor position
Split items at prior zero crossing	Splits currently selected items at the last zero crossings point before the current cursor position.
Split items at time selection	Splits currently selected items at the start and end of the currently selected timeline area.
Heal splits in items	Removes splits and joins items as one again.

23.5 The Media Items Context Sub-Menus

Several of the Media Items context menu commands cause substantial sub-menus to be displayed, including Item settings, Take, Comp, Item and take colors and Item processing. These are explained below.



Item settings Sub Menu Commands	Comments
Mute Loop item source Play all takes Lock item	Toggles these various Item Properties parameters. These can also be modified in the Item Properties dialog box. There are also icons that can be used for Mute and Lock item.
Item notes ...	Opens Item Notes window.
Invert phase	Toggles phase invert.
Loop section of item source	Toggles loop selection status.
Preserve pitch when changing playrate	Toggles preserve pitch option.
Reverse active take	Reverses the current active take.
Take channel modes	Several mutually exclusive options, including Normal, Reverse stereo, Mono (downmix), Mono (left), Mono(right). You can also select your own mono or stereo pair take channel modes. Default is Normal.
Set item timebase	Four mutually exclusive options used to set item timebase: Project/track default, Time, Beats (position, length, rate) or Beats (position only).
Item and takes colors sub menu commands	Comments
Set items to ...	Choose Custom Color, Random Color, One Random Color or Default Color.
Set active takes to ...	Choose Custom Color, Random Color, One Random Color or Default Color.
Take sub menu commands	Comments
Next take Previous take	Causes the next or previous take to be selected.
Delete active take	Causes the currently active (selected) take to be deleted.
Crop to active take	Crops all other takes for this item to the currently active take.
Duplicate active take	Creates a duplicate copy of the currently active take.
Lock to active take	Locks currently active take (toggle).
Show FX chain for active take	Opens FX chain for the currently active take.
Remove FX for active take	Removes all FX from the take's FX chain.
Take envelopes ...	Opens the Envelopes for takes window where you can add automation envelopes to the take for volume, pan, mute and/or pitch, and for any take FX parameters.

23 - Main Right-Click Context Menus Summary

Explode all takes to new tracks Explode all takes (in place) Explode all takes (in order)	Three options for exploding takes.
Implode items across tracks into takes Implode items on same track into takes	Creates one track with a take for each media item selected, where the media items are selected across several tracks, or creates one track with a take for each media item selected, where the media items are all selected from the same track.
Paste to takes in items	Pastes to takes in selected items.
Take lane 1, Take lane 2, etc	Makes the selected take active.
Comps sub menu commands	Comments
Save as new comp ...	Saves current takes selection as a new comp.
Remove active comp from list	Removes current comp from Comp sub menu.
Crop list to active comp	Removes all comps except current one from sub menu.
Move active comp to top lane	Moves take selection for active comp to top media item lane.
Saved comp names	Where comps have been named, these are listed on, and can be made active by selecting from, the Comps menu.
Item processing sub menu commands	Comments
Normalize items	Normalizes all selected items, independently of each other.
Normalize items (common gain)	Normalizes as far as possible all selected items, adding the same amount of gain to each.
Dynamic split items ...	Opens the dynamic split dialog box for dynamic splitting.
Quantize item positions to grid	Quantizes the positions of selected items to grid settings.
Move items to source preferred position	Moves items to original position.
Implode items across tracks into items on one track.	Merges the selected items into a single track.
Auto-reposition items in free positioning mode	Sets the status of selected items to free positioning mode.
Explode multichannel audio or MIDI items to new one channel items.	If the media item is a multichannel one, this command will create an additional new mono track for each channel used. If it is a MIDI item, it will explode (or "dissolve") MIDI channels.
Explode MIDI items by note row (pitch).	Dissolves MIDI items by note row instead of channel.
Convert active take MIDI to in-project event	Changes a previously ghost copied item into a project event in its own right.
Convert active take MIDI to file (ghost copyable)	Changes the status of the active MIDI take so that it can be ghost copied.
Import media cues as project markers	Converts existing media cues in an imported item into REAPER markers.
Propagate take/items to similarly named active takes/items on tracks	Copies media item properties and features (such as FX, fades, envelopes) to other similar takes items in track.

23.6 The Record Arm Context Menu

This menu is accessed by right-clicking over the Record Arm button or VU meter of any track. An explanation of the commands follows.

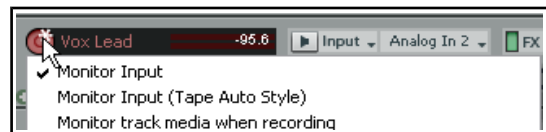

Command	Comments
Monitor Input ... Monitor Input (Tape Auto Style) Monitor track media when recording Preserve PDC delayed monitoring in recorded items.	The first two of these options are mutually exclusive: you should select whichever of these you prefer if you wish to use REAPER's input monitoring. You do not need to select either of these options, however, if using any input monitoring facility supplied by your sound card. Optionally, you may choose to also monitor track media when recording.

Command	Comments
Record: input (audio or MIDI)	In most cases, for normal audio recording you will want to select Record: input to record the incoming audio signal.
Record: MIDI overdub/replace	Displays submenu of MIDI overdub options: MIDI overdub, MIDI replace, MIDI touch-replace and MIDI latch-replace.
Record: output	Displays submenu of record output options: multichannel latency compensated, multichannel, stereo latency compensated, stereo, mono latency compensated, mono or MIDI.
Record input (force format)	Displays sub menu of forced recorded input options:force mono, force stereo, force multichannel and force MIDI.
Record: disable (input monitoring only)	Allows for input monitoring without recording.
Input: Mono	Displays sub menu from which to select the required mono input from your sound card.
Input: Stereo	Displays sub menu from which to select the required stereo input from your sound card.
Input: 8 channel	Allows input from 8 channels, subject to the capabilities of your audio device.
Input: MIDI	Displays a menu from which to select your required MIDI device and channels
Input: None	Disables recording input.
Automatic record-arm when selected	Causes the track to be auto armed when selected.
Track recording settings ...	Opens Track Recording Settings dialog box, to change recording format settings and/or input quantize settings for this track.
Track input FX chain...	Opens FX browser to select FX to be used when input is recorded.

23.7 The Envelopes Context Menu

The envelope menu (left) is commonly accessed by right-clicking over any existing point on an envelope. Right clicking over an existing envelope but not on a specific point produces a similar menu, but instead of point editing commands such as **Set point value...** and **Set point shape**, you will find the command **Create new point**. An explanation of this menu appears below.

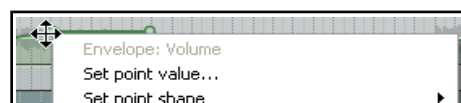

Command	Comments
Envelope defaults	For each envelope type, set default shape. For volume envelopes, also specify whether amplitude scaling or fader shading is required.
Create new point	Creates new envelope point at current cursor position.
Set point value...	Opens a dialog box in which you can specify a different value for the specific point, and, if you wish, position and shape.
Set point shape	Lets you specify any of the six available shapes for the current point.
Set shape for selected points	Sets shape for all points in current selection.
Select all points	Selects all points in the envelope.
Unselect all points	Unselects all points in the envelope.
Select all points in time selection	Selects all points on the envelope that are contained within the currently selected area along the timeline.
Copy points	Copies currently selected envelope point or points to the clipboard.
Cut points	Cuts currently selected envelope point or points to the clipboard. Pressing Ctrl V causes cut or copied points to be pasted onto whichever envelope is currently selected, at the cursor position.
Delete point	Deletes the envelope point.
Delete selected points	Deletes all currently selected envelope points.
Delete points in time selection	Deletes all points on current envelope that are contained within the currently selected area along the timeline.

23 - Main Right-Click Context Menus Summary

Command	Comments
Invert selected points	Causes currently selected envelope points to be inverted.
Reset points to zero/center	Resets currently selected envelope points effectively to a "neutral" value.
Reduce number of points	Displays the Reduce Points dialog box, enabling you to reduce the number of points in either the whole envelope or only the current time selection.
Arm envelope for recording	Arms the envelope ready for recording, for example to write automation changes to the envelope.
Show envelope in lane	Determines whether envelope will be shown in its own lane or not.
Hide envelope	Hides the envelope whilst keeping it active. Hidden envelopes can be redisplayed using the Envelopes window.
Bypass envelope	Toggles the bypass state of the envelope.
Clear or remove envelope...	Removes all points from the current envelope. You are prompted to indicate whether you also wish to remove the envelope completely.

Right clicking over the background area of any envelope lane in the track control panel will produce a context menu with three sets of commands:

Existing available envelopes: Used to change the envelope displayed in this lane.

Envelope management: Commands to show, hide, arm or disarm all envelopes on this track, or to move all visible envelopes into or out of lanes.

Automation mode: Change your required automation mode for this track.

23.8 The Transport Bar Context Menu

This is accessed by right-clicking on the Transport Bar. An explanation of the menu commands appears below. More specific context sensitive menus are available by right clicking over many of the items on the transport bar. For example, right-clicking on the **Record** button gives you a menu of the three record mode options. Right clicking on the play rate fader displays the play rate sub menu.



Command	Comments
Jump to marker	Displays a fly out menu of markers. Click on any marker in the list to jump to it.
Playrate	Displays a sub menu of options for adjusting the play rate (with or without preserving pitch) and to set the play rate fader range.
Transport	Displays a sub menu of various actions equivalent to the Transport control buttons - play, record, pause, stop, go to start, go to end, etc.
External timecode Synchronization	Used to synchronize REAPER's clock to an external device.
Automatically scroll view during playback	When selected, screen display follows play cursor during playback.
Continuous scrolling	Toggles continuous scrolling on and off.
Smooth seeking (seeks at end of measure)	When enabled, moves play cursor on stop/pause to end of measure.
Chase MIDI note-ons in project playback	When enabled, ensures events starting before playback (but continuing into or past the playback start position) will be processed
Stop playback at end of loop if repeat playback is disabled	Toggles this option on and off.
Record mode: normal Record mode: time selection auto punch Record mode: auto-punch selected items	Selects one of the three recording modes explained in Chapter 3. The three options are mutually exclusive.
Use ruler time unit	Ensures that the time unit selected for the ruler is also used on the Transport Bar. Alternatively, you can select one of the other options (below).

Up and Running: A REAPER User Guide v 5.24

Command	Comments
Minutes:Seconds Measures.Beats/Minutes:Seconds Measures.Beats Measures.Beats (minimal)/Minutes:Seconds Seconds Samples Hours:Minutes:Seconds:Frames Absolute Frames	Select your preferred unit of measurement for display on the Transport Bar. These options are mutually exclusive.
Show playrate control	Toggles on and off display of playrate controls in transport bar,
Show time signature	Toggles on and off display of time signature in transport bar.
Show play state as text	Toggles on and off text display of play state in transport bar – Playing, Stopped, etc.
Center transport controls	Toggles display of transport controls in center or on left.
Dock transport in docker	Toggles docking transport bar in one of REAPER's dockers.
Dock transport in main window	Toggles on and off docking of Transport Bar in REAPER's main window.
Docked transport position	Offers a submenu of four options for the position of the transport bar when docked in REAPER's main window.
Hide transport	Hides the Transport Bar. To redisplay, press Ctrl Alt T .

23.9 The Routing Matrix Context Menu

This menu is displayed by right-clicking on the empty background area of the matrix. The commands mainly determine which items are and are not shown in the routing matrix. Exactly which items you will wish to show will vary at different times in your project's life cycle. Making the right selection for the right time can prevent screen clutter and make the matrix easier to work with.

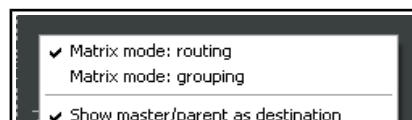

Command	Comments
Matrix mode	Decides whether the routing, grouping or regions matrix is shown.
Show ---- as destination	Determines which items are and are not shown as destinations for sends in the header row.
Show ---- as sources	Determines which items are and are not shown as sources of sends in the left hand column.
Dock routing window in docker	Determines whether the matrix is or is not docked.

23.10 The Grouping Matrix Context Menu

Right-click on the background area to display this menu. The commands are summarized below.

Command	Comments
Matrix mode	Decides whether the routing, grouping or regions matrix is shown.
Show individual group details	Determines whether individual details (Vol, VCA, Pan, etc.) are shown for each group, or only a group summary matrix.
Dock routing window in docker	Determines whether the matrix is or is not docked.

23.11 The FX Window Context Menu

This menu is accessed by right-clicking within any track's FX chain window. An explanation of the commands on this menu appears below.



Command	Comments
Add FX ...	Opens Add FX Window to add one or more plug-ins to the FX chain.

23 - Main Right-Click Context Menus Summary

Command	Comments
Replace FX...	Opens Replace FX window to replace selected FX with another.
FX chains	Displays a sub-menu with options for loading and saving FX chains, including saving current FX chain as the default for new tracks and loading default FX chain into this track or item.
Freeze track	Displays sub menu with options for freezing (e.g. mono, stereo or multichannel, up to last non-offline FX or up to last selected FX).
Copy all FX	Copies all FX in chain to clipboard.
Copy selected FX	Copies currently selected FX to clipboard.
Cut selected FX	Cuts currently selected FX to clipboard.
Paste FX	Pastes FX from clipboard into current FX window.
Remove selected FX	Removes all selected FX from current FX window.
Remove all FX	Removes all FX from current FX window.
Toggle selected FX bypass	Toggles bypass of all currently selected FX.
Toggle selected FX offline	Toggles online/offline status of all currently selected FX.
Rename FX Instance	Allows you to assign a specific name for this instance of the plug-in.
Window float selected FX	Floats selected FX so that they are displayed as separate windows.
Send all keyboard input to plug-in	Toggles the option for all keystrokes to be directed to a plug-in while it is selected and active.
Build multichannel routing for output of selected FX	Creates multichannel/multitrack where appropriate: for use with multichannel VSTis and Dxis.
Build 16 channels of MIDI routing to this track	Where appropriate, for use with multichannel VSTis and Dxis.
Dock FX window in docker	Toggles the docked/undocked status of the FX window.
Close FX window	Closes the FX window.

23.12 The Media Explorer Context Menu

Right-clicking over any vacant area within this window produces a context menu that is the same as the Media Explorer's Options menu. In addition, right-clicking over the name of any media item will produce its own context menu.



Command	Comments
Open project	RPP files only. Opens the project either in place of the current open project, or in a new project tab.
Open project in new tab	
Insert into project	Inserts into selected track at play cursor position.
Insert at time selection (stretch/loop to fit)	Inserts into selected track at time selection, stretching/looping to fit.
Insert into project on a new track	Inserts at play cursor position on to a new track.
Insert as take in selected items	Adds the selected item in the media explorer to the selected item in Arrange view as a new take.
Use as media source for selected items	Replaces current media source in item currently selected in Arrange view.
Use as media source for selected item (stretch/loop to fit)	Replaces current media source in item currently selected in Arrange view, stretching/looping to fit.
Preview	Previews this item.
Show in Explorer/Finder	Shows selected file in Windows Explorer (PC) or Finder (Mac).

23.13 The MIDI In-Line Editor and MIDI Editor Context Menus

Insert note at edit cursor	Ctrl+Num 5
Copy	
Cut	
Paste	Ctrl+V
Paste preserving position in measure	Ctrl+Shift+V
Select all notes	
Delete notes	
Split notes	S
Join notes	J
Mute events	Alt+M
Reverse	
Note properties...	Ctrl+F2
Note channel	
<hr/>	
Quantize...	Q
Quantize using last settings	
Quantize position to grid	
Unquantize	
Freeze quantization	
Humanize notes...	H
Select all notes with same note value	
Remove duplicate notes	
Set note ends to start of next note	
<hr/>	
View	
Drawing or selecting a note sets the new note length	
<input checked="" type="checkbox"/> Preview notes on add/edit	
<hr/>	
Load color map from file...	
Clear color map (use default)	

Right-clicking within the MIDI In-Line Editor the context menu shown here. These commands are a subset of some of the MIDI Editor's menu commands and are explained in detail in Chapter 13.

The first section (from **Insert note at edit cursor** to **Note channel**) contains the same commands as the right click notes menu in the MIDI Editor.

The **Note channel** command displays a sub menu of channels 1 thru 16.

The second section (from **Quantize events** to **Set note ends to start of next note**) can also be found on the **Edit** menu in the MIDI Editor's main menu.

The **View** command leads to a sub-menu similar to the View command on the MIDI Editor main menu.

The remaining commands include some of the other options found on the MIDI Editor's main menu.

The MIDI Editor Main Context Menu

Right clicking over the title bar in the MIDI Editor (or tab if docked) produces a composite menu made up of all the commands on its main menu. The commands are grouped, first the **File** commands, then **Edit** commands, then **Navigate** commands, then **View**, then **Actions**, then **Navigate**.

These commands are explained in detail in Chapter 13.

The MIDI Editor edit area context menu

Right-clicking on the editing area of the MIDI editor displays a menu of mostly note editing commands.

Some of these commands (e.g. Copy, Cut) will only be available if a selection of notes has been made.

Most of the other commands are duplicated from the Edit menu.

In addition, there are a number of handy note selection commands, such as **Select previous note with same note value**, **Select next note with same note value**, and **Select all notes with same note value**.

24 Using REAPER with Other Applications and Devices

24.1 What is ReaRoute?

ReaRoute is an ASIO driver that allows you to route audio to and from any other ASIO enabled application. ReaRoute is only installed on your system if you select the **ReaRoute ASIO driver** during the REAPER installation process.

This option is found on the REAPER Setup screen on the **Choose Components** page (shown right), under the heading **Additional Functionality**.

If you did not have this option selected (or if in doubt) when you last installed REAPER, simply reinstall REAPER, this time making sure that it is selected.

When you install ReaRoute, the **ReaRoute ASIO driver** appears in the ASIO driver list for the other audio applications on your system.

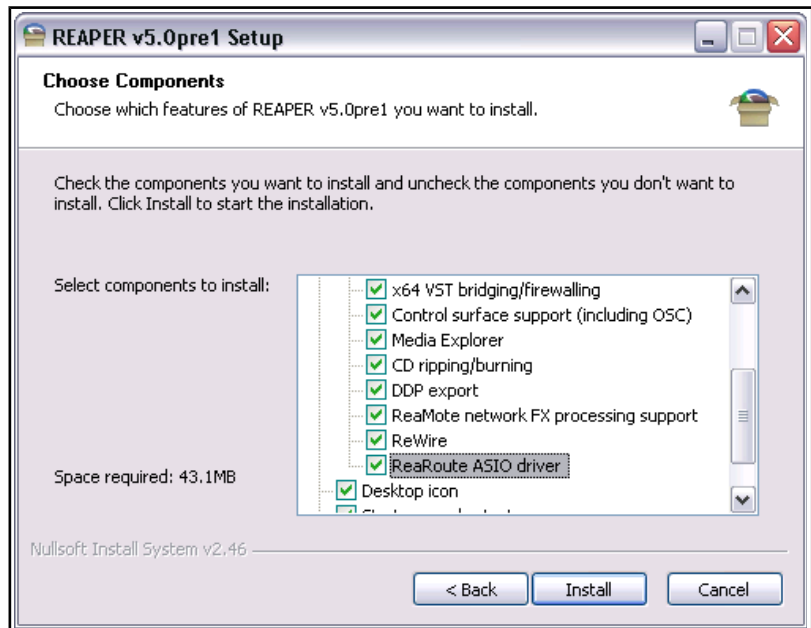

Note: Some users have reported problems with native ASIO drivers after installing the ReaRoute driver. If you experience problems with your ASIO drivers after installing this feature, uninstall REAPER, then re-install with this check box cleared.

Once ReaRoute has been installed, you can pass audio streams between REAPER and other audio applications. This could, for example, be another DAW such as Cubase or Ableton Live or Sonar, or a stand-alone synth such as Cakewalk's Project 5. In overview, the basic steps are:

- Set up the other application to work with ReaRoute.

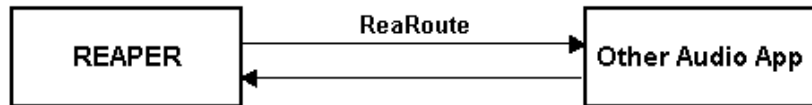

- *Either* Send audio from REAPER to another DAW \ and record it track by track within that application.
- *Or* Send audio from the other DAW to REAPER, this time bringing it in as a series of submixes. You can then apply REAPER features to that project.
- *Or* Use a stand alone synthesizer workstation such as Project 5 in conjunction with REAPER.

24.2 Setting Up Applications for ReaRoute

Before you can use any audio application with REAPER via ReaRoute, you need to ensure that the audio settings for that application are set up correctly. There are usually one or two basic steps involved.

The first is to enable **ReaRoute ASIO** as the preferred driver, the second is to enable the various input and output channels required to transmit audio between the application and REAPER. With some applications, this second step is not required. The method will vary with the application, but always involve specifying your preferences on the **Audio Settings** dialog box (or similar).

The table below gives some examples. They are accurate at the time this is being written, but be aware that all software programs are likely to change over time.

Note: Before setting up or using any application for use with ReaRoute, you should:

- ◆ Make sure that the ReaRoute ASIO Driver has been installed (see previous page), and
- ◆ Make sure that REAPER is open and minimised.

Up and Running: A REAPER User Guide v 5.24

Application	Instructions
Ableton Live	<ol style="list-style-type: none">1. Options, Preferences then click on the Audio tab.2. Set Driver Type to ASIO.3. Set Audio Device to ReaRoute ASIO.4. Click on Input Config then on each input channel that you wish to enable, then OK.5. Click on Output Config then on each output channel that you wish to enable, then OK.6. Close Preferences window.
FL Studio	Options, Audio Settings , then select ReaRoute ASIO for Output . Close Audio Settings window.
Project 5	Options, Audio then under Audio Driver Selection – Outputs select ReaRoute ASIO ReaRoute Client -> REAPER 1 (ASIO) then OK .
Sonar	<ol style="list-style-type: none">1. Options, Audio, Advanced then set Driver Mode to ASIO then OK.2. Options, Audio, Drivers then disable all existing drivers (input and output)3. Options, Audio, Advanced then set Device to ReaRoute ASIO (8 in, 8 out) then OK4. Options, Audio, Drivers and enable all ReaRoute drivers, then OK. <p>Note: These instructions are for Sonar 8.5. Some earlier versions of Sonar require that you exit and restart the program before certain changes to audio settings are applied. Because of this, you may not be able to complete all of these steps at once – you may find that you have to close and reopen the program after each step before you can go on to the next one.</p>
Tracktion	<ol style="list-style-type: none">1. Click on the Settings tab.2. From the Wave Device drop down list choose ReaRoute ASIO.3. Click once on the red word disabled for each channel that you wish to use. The display should change for each item clicked on to green enabled.4. Click on the Projects tab when finished.

If you are using any of these, or any other audio application, and having difficulty in setting it up, ask for help on the REAPER forum.

24.3 Sending Audio from REAPER to Another Application

This example looks at sending a project from REAPER to another DAW. You might wish to do this, for example, to use one of that DAW's native plug-ins on a track or series of tracks. Provided you know your other application well enough and have already set it up to use ReaRoute (see previous page) you should be able to apply these guidelines. They are:

1. Open REAPER. *It is important that you open REAPER before the other application.*
2. Open the project file that you wish to use. For each track that you wish to use, create a hardware output to a different ReaRoute channel.
3. Open the other application (e.g. Sonar, Cubase, Ableton Live) and create a new project file.
4. Insert into your new file one new track for each track that you wish to bring in from REAPER. For each track, the input should be set to correspond with the equivalent output used in REAPER. For example, if in REAPER you set a track's output to *ReaRoute Channel 1*, then the corresponding new track in your other DAW will need to have its input set to *Left ReaRoute ASIO ReaRoute REAPER Channel 1*.
5. Within the second application, start recording. Within REAPER, play the song.
6. Stop both when the song finishes.

24 - Using REAPER with Other Applications and Devices

7. You can then do whatever work you wish.
8. When finished, first close the other application and then close REAPER. You should always remember – *Open REAPER first, close it last.*

In many cases it would be easier and quicker simply to import the wave files directly into the other application. There are, however, other instances when it may be advantageous to use ReaRoute instead. For example:

- It might not be easily possible to line up all tracks. Some may start and finish at different times. Others might consist of a large number of media items each of short duration. It would be difficult to import these piecemeal.
- Some tracks might consist of a combination of MIDI items and audio items. Many applications do not let you mix MIDI and audio on the same track. This way, they are all taken across as audio.

24.4 Sending Audio From Another DAW App to REAPER

Staying with the same example, we are now going to use ReaRoute to take our open Sonar project and send an audio signal back to REAPER. In overview, this is how it is done.

1. Open REAPER and create a new project file. Insert as many tracks as you need.
2. Assign ReaRoute inputs to these tracks as required (see right). Arm these tracks for recording.
3. Open the other DAW. In that DAW, open the file you wish to work on, and assign outputs on a track by track basis to your various ReaRoute channels as required.
4. Still in the other DAW, insert any FX that you may wish to use in these tracks. Play the song in the other DAW, adjusting your FX to suit.
5. When ready, start recording in REAPER, then play the song in the other DAW, from the beginning.
6. When finished, stop both playback and recording.

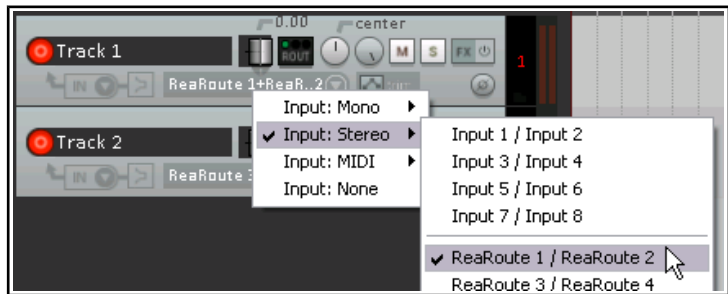

24.5 Using REAPER With a Synth Workstation

ReaRoute can be used to make the functionality of a stand-alone synthesizer available to you when you are working with REAPER. To be able to work thru this example, you will need to already possess a good working knowledge of how to use the synthesizer.

Before proceeding, you will need to ensure that your ReaRoute ASIO drivers have been installed and that the Synth Workstation program has been set up to use them.

1. Open REAPER. Open an existing project file, or create a new one and insert a track.
2. Arm this track for recording. Turn on input monitoring and set the track input to stereo. Assign a pair of ReaRoute channels (probably 1 and 2) to this input.
3. Open the synth program and take whatever steps are needed by way of preparation.
4. Direct audio output to the same pair of ReaRoute channels that you selected at step 2. (above).
5. In REAPER, make sure the play cursor is positioned where you want it. Press **Record**.
6. Within the synth program, play the instrument(s) to compose a track to accompany your REAPER song. As you do so, REAPER will record it as a wave file.
7. When finished, save your work.

24.6 Syncing to an External Device

If you are using REAPER in conjunction with an external device then you may need to ensure that your DAW is in sync with that device, and to take its time clock from that device. For example, you may need to slave REAPER to another DAW, or to a video deck. Another example might be if you need to upload time-stamped material from ADAT tape.

To synchronize REAPER to an external timecode, follow this sequence:

Up and Running: A REAPER User Guide v 5.24

- Right click over the **Play** button on the Transport Bar. This opens the settings dialog box shown here.
- Select the Input to be used. Available sync types include ASIO Positioning Protocol, MTC and SPP.
- Complete the other settings and close the dialog box. You should consult the documentation of your external device for further information.
- To play REAPER in sync with an incoming timecode, hold the **Alt** key while right clicking on the play button. **Alt Right Click** over the Play button toggles this slave to timecode on and off.

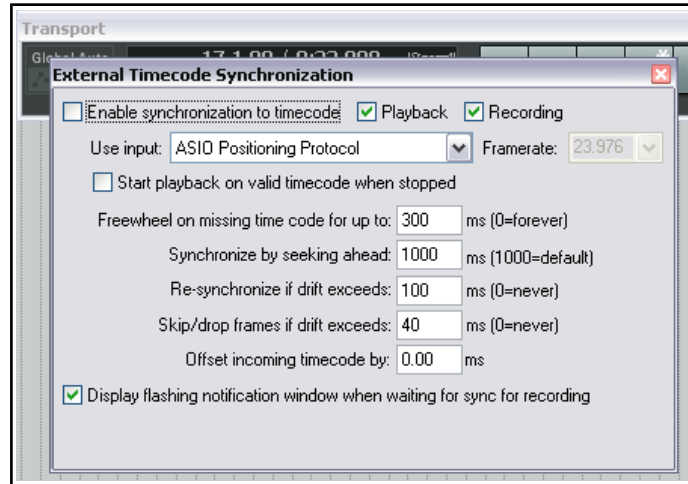

REAPER Sync Types (Summary)

Sync Type	Comment
ASIO Positioning Protocol	Creates a sample accurate synchronization with the external device, i.e. the time code has as many time locations as your project's sampling rate. Requires that your audio hardware uses ASIO 2.0 drivers.
Linear Time Code (LTC)	This is the same as SMPTE. It is a time based method of synchronization which uses hours, minutes, seconds and frames.
MIDI Time Code (MTC)	As its name implies, this is also a time based method of synchronization which uses hours, minutes, seconds and frames. It is simply a conversion of the SMPTE code that is transmitted via the MIDI cable.
Song Position Pointer (SPP)	This method is based on bars, beats and subdivisions of beats. The information is transmitted along with MTC data, every six clocks or ticks. For some devices, this is all you need.

The Context Menu

The commands for enabling/disabling external timecode synchronization and for changing the settings are also available on REAPER's **Transport Bar** context menu and on the main **Options** menu. From either of these menus you can choose **External Timecode Synchronization...** then either the toggle command **Synchronization enabled** or **Synchronization settings**. Both these commands can be assigned as actions within REAPER's Actions List.

Sending Clock/SPP from REAPER to an external MIDI Device

To send Clock/SPP data from REAPER to an external MIDI device, you need to enable the feature under **Options, Preferences, MIDI Devices**.

Double-click on the MIDI output device name to open the **Configure MIDI Output** dialog box, and select the option **Send clock/SPP to this device**. There is also an option to **Open device in low latency/low precision mode**.

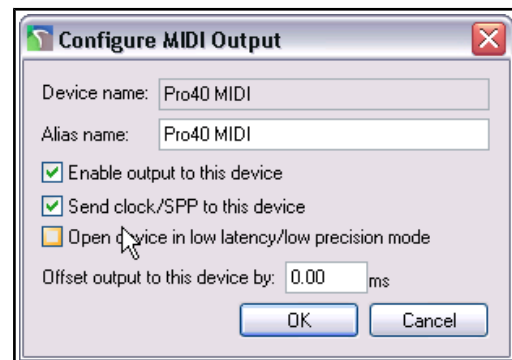

24.7 Generating and Sending Timecode

The command **Insert, SMPTE LTC/MTC Timecode Generator** (from the main menu) can be used to send a synchronization timecode from REAPER to an external device. This command inserts on to the current track a media item which is used to generate the timecode.

Right-click over the item and choose **Source properties** from the context menu to display the settings box shown here.

Select LTC (linear/longitudinal time code) or MTC (MIDI time code) and configure the various parameters as required.

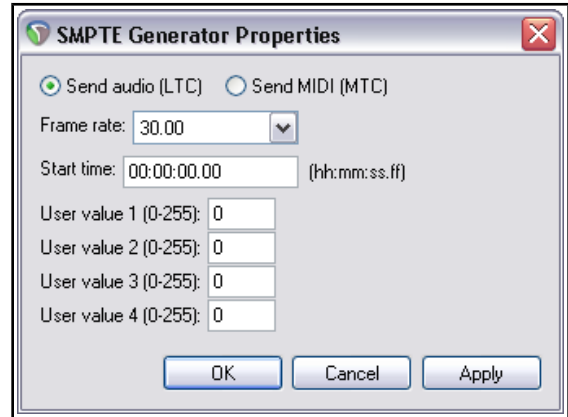

24.8 Slaving REAPER to MIDI Sequencer Software

REAPER can be slaved to a software MIDI sequencer (such as Temper) as well as to an actual hardware device. You will also need some virtual MIDI cable software, such as the highly popular MIDI Yoke. Here is an overview:

1. Use MIDI Yoke to install a virtual MIDI cable to send MIDI out from your other program and in to REAPER.
2. Start REAPER. Go to Preferences, Audio, MIDI Devices. Right click over the MIDI device labelled *In from MIDI Yoke: 1* (or similar) and choose **Enable input for control messages**. OK preferences.
3. Right-click REAPER's Play button, enable the **Enable synchronization to timecode box** option (see right) and enable playback, recording, or both. Select the required MIDI input port (in this example *MTC: In from MIDI Yoke 1*). When you close this dialog box, the play button will display a small padlock and the tooltip *slave to timecode*.. Engaging this play button will now mean it is ready and waiting for. sync input.
4. In the external program, add a MIDI track and direct its output to the same MIDI Yoke cable as you used for input in REAPER. You may also need to enable *Send MTC* (Midi Time Code) in this program. How you do this in any specific program will of course depend on its own features, interface and capabilities. You will now be ready to go.

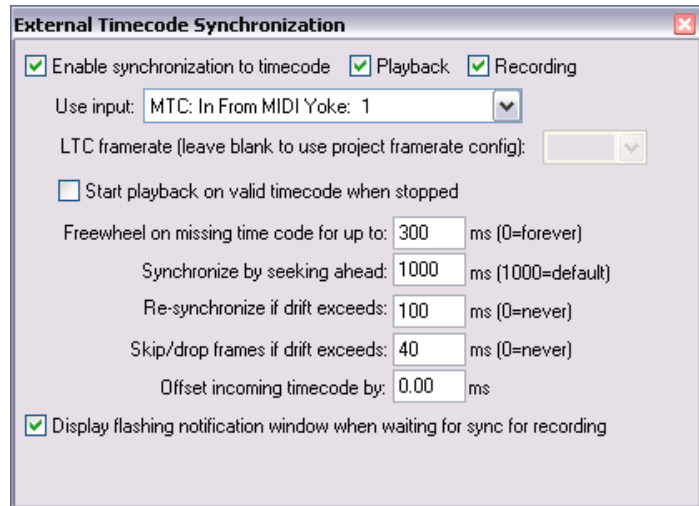

For assistance with how to do this with any specific software, consult or ask on one of the REAPER forums.

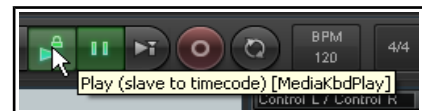

24.9 ReaMote

ReaMote is REAPER's network FX functionality. It allows you to have any FX chain in your project processed on a remote machine on your local network. This is useful if you want to add more CPU power to your project (to run various FX) without upgrading your main host's CPU. You will need to set up ReaMote and install REAPER and your plug-ins on the slave machines.

For OS X users, ReaMote can be installed when REAPER is installed, by dragging and dropping the ReaMote icon into the Applications folder icon. For Windows users, make sure when installing REAPER that you have **ReaMote** selected and enabled under **Additional functionality** on the **Choose components** page of the install wizard. Run the ReaMote slave on the slave machines, then enable **ReaMote** in the **REAPER Preferences** on the master, specify your settings and options, and you're ready to go!

To learn more about how to set up and use ReaMote, go to wiki.cockos.com/wiki/index.php/ReaMote.

24.10 REAPER and NINJAM

NINJAM is an innovative software program that allows musicians to collaborate in "fake time" over the Internet. The software connects to a central server where participants can share audio and text information, and has the ability to record both the local and remote channels of each "session" (audio only). REAPER has the ability to import these recorded session files to allow you to edit and mix at your leisure. "Fake time" means that some players will hear a delayed version to which they play along.

To learn more about the NINJAM software or download a copy, visit www.cockos.com/ninjam/

To learn more about using NINJAM with REAPER, visit the Cockos WIKI wiki.cockos.com/wiki/index.php/NINJAM_Documentation

24.11 ReaScript

ReaScript is a scripting language that takes your ability to customize REAPER well beyond that offered by the Actions List editor. With ReaScript, you can not only create more powerful and sophisticated macros, you can even create your own extension commands. To use ReaScript, you will need to have a good knowledge of a scripting language such as EEL, Lua or Python. EEL and Lua are embedded in REAPER. You can download Python from the **Options, Preferences, Plug-ins, ReaScript** window (shown here).

ReaScript isn't for everyone – in fact, because it requires an understanding of programming it isn't for most people.

You can find out more about ReaScript by choosing **ReaScript documentation** from REAPER's **Help** menu, and by clicking on the option **View ReaScript Help** on the Plug-ins, ReaScript page of REAPER's Preferences window.

For more about ReaScript and how to get started see also <http://www.cockos.com/reaper/sdk/reascript/reascript.php>

To be able to use Python, enable it under **Options, Preferences, Plug-ins, ReaScript** (above). On the **External Editors** preferences page you can also specify an external editor for writing and editing scripts.

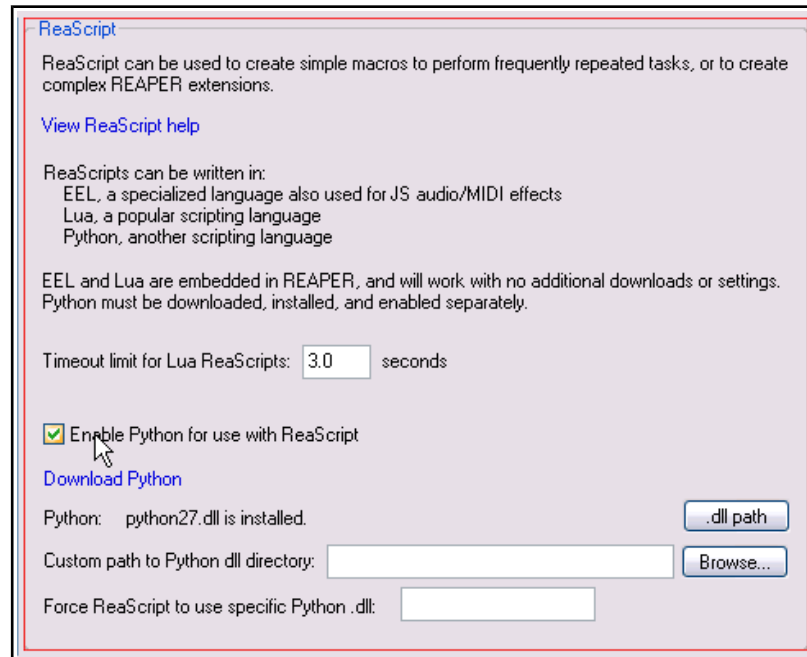

25 Troubleshooting REAPER

This section aims to help you resolve problems that are sometimes encountered by new users.

25.1 Input/Output Issues

Input Output Issues	
Problem	Diagnosis and Possible Solution
<p>When I play back, my audio track is silent, even though there is activity in the track's VU meter.</p>	<p>The problem is likely to be either with your routing in REAPER, your sound card's settings or with your audio hardware setup.</p> <p>REAPER's Routing: Make sure that the track's output is directed to the master. Make sure that the Master output is directed to the outputs on your sound card to which your speakers or headphones are attached.</p> <p>Sound Card Settings: Use the control software supplied with your soundcard to make sure that none of the following has occurred:</p> <ul style="list-style-type: none"> • Output muted, or volume lowered too much. • Output patched to different hardware output. <p>Audio Hardware Setup: Make sure that the amplifier is connected to the same outputs on the soundcard as the output of the Master. Make sure that everything is connected to the power supply, switched on, and with appropriate volume levels. Use Windows Device Manager (Control Panel, System, Hardware, Device Manager, Sound Video and Game Controllers) to ensure the device is enabled and functioning correctly.</p> <p>Tips: Opening a different audio application and playing any wave file can help you determine whether the problem lies within REAPER or with your Sound Card or Audio Setup.</p>
<p>I get an error message to the effect that MIDI device(s) cannot be opened</p>	<p>The device may not be connected, or may be in use by another program.</p> <p>Check that the device is connected and supplied with power. Check whether another program has use of the MIDI device. Check that you have not accidentally opened REAPER twice.</p>
<p>When I play back, my audio track is silent, and there is no activity in the track's VU meter.</p>	<p>The problem is likely to be specifically related to that track or item, especially if you have other projects which do play correctly.</p> <p>Make sure that the track has not been muted. Make sure that the item has not been muted (right click over item, Item Properties). Check the FX Window for the track to make sure there is no FX which is causing the track to be silenced. Check the track's volume fader to make sure it is not set too low.</p>
<p>When I play back, I don't hear some or all of a track's FX being applied</p>	<p>The problem could be happening in the track's FX window or in the plug-in's own window, or both.</p> <p>Check that the track's FX Window has not been set to bypass mode. Check that the individual FX has not been set to bypass mode. This might occur in the FX Chain window or with some plug-ins within the plug-in's own window.</p>

Up and Running: A REAPER User Guide v 5.24

Input Output Issues	
Problem	Diagnosis and Possible Solution
	<p>Check that the plug-in's Wet/Dry mix setting (where present) has not been set to 100% dry.</p>
<p>When I play back, I get clicks, pops, stutters or dropouts</p>	<p>This probably means that you are attempting to play this project at a latency too low for your system. This is more likely to happen if you use a large number of CPU hungry FX such as Reverb. Try one or more of these remedies:</p> <p>Consider whether you can rearrange your mix to use fewer CPU intensive plug-ins, for example by making more use of FX busses to share FX used by more than one track.</p> <p>If you are using a high sample rate, such as 88200 or 176400, try a lower one. Go to File, Project Settings and reduce the Sample rate to 44100. This will reduce the load on the CPU and you will probably find that you can live with any perceived difference in sound quality.</p> <p>Consider increasing buffer size. This will increase latency, but should not be a problem when playing back. Go to Options, Preferences, Audio Device. Click on <i>ASIO Configuration</i> to bring up the Control Software for your sound card. Increase buffer size, perhaps to 1280 samples.</p> <p>Check your Audio Buffering preferences, especially for FX processing/multiprocessing. Be prepared to experiment with <i>Render ahead size</i> and with which options are allowed.</p>
<p>When I play back, the Master clips into the red and distorts, even though the track level(s) appear quite low</p>	<p>This can arise as a result of routing problems, for example when you have any track or tracks routed to the Master by several different routes at the same time.</p> <p>Check the Routing Matrix</p>
<p>When I play back, the audio sounds clipped, even though it doesn't appear to be visibly clipping anywhere</p>	<p>This could be caused by a routing problem, or by some FX or combination of FX which might be distorting your sound.</p> <p>Check the Routing Matrix to see if any track or tracks is/are being directly routed to the same audio hardware output as the Master. If this isn't the cause of the problem ...</p> <p>Disable all FX to see if this fixes the problem.</p> <p>If it does, reintroduce the FX gradually until you can identify which is causing the problem.</p>
<p>When I try to play an imported MIDI track, it is silent</p>	<p>This can be a routing, sound card or setup issue – see previous page. In addition it may be caused by a MIDI specific issue. This occurs when the track has not been assigned to a valid MIDI Output device or software synthesizer.</p> <p>If you are using a MIDI Hardware device, display the track's Routing Window and make sure it is assigned to a MIDI Hardware Device.</p> <p>If you are not using a MIDI Hardware device, display the FX Window for the track, and insert a software synthesizer of your choice (usually DXi or VSTi).</p>
<p>When I try to record audio, nothing is recorded</p>	<p>The problem here could lie either with your REAPER settings or with your hardware set up.</p> <p>Make sure the track is armed for recording.</p> <p>Make sure that the track has been assigned an input.</p> <p>Check (Options, Preferences, Audio Device) that your range of audio inputs has been defined <i>and enabled</i>.</p> <p>Make sure under the Options menu that you have the correct</p>

Input Output Issues	
Problem	Diagnosis and Possible Solution
	<p>required Record Mode set (usually this should be Normal). Check that <i>Record Input</i> is enabled. Or, if you have selected <i>Record Output</i>, check the FX window for any FX that could be silencing the track's output.</p> <p>Make sure that the microphone or lead for the instrument being recorded is connected to the correct audio input.</p> <p>If the microphone requires phantom power, make sure that the phantom power supply is enabled.</p> <p>Check your audio input mixer (external hardware desk, sound card mixer software, or both) to make sure that the incoming signal is correctly routed.</p> <p>Check your audio input mixer (external hardware desk, sound card mixer software, or both) to make sure that the incoming signal is not muted.</p>
<p>I don't have enough CPU to play back my project</p>	<p>Almost certainly, this is because you are trying to use more FX than your DAW can handle.</p> <p>Use the Performance Meter to determine which tracks are using the most CPU hungry FX.</p> <p>Then right click over the media items for those tracks and either Apply FX to items as new take or Apply FX to items as new take (Mono).</p>

25.2 REAPER Interface Issues

Interface Issues	
Problem	Diagnosis and Possible Solution
<p>When I press Space (or some other Transport Control), nothing happens</p>	<p>This happens when focus is with another window, such as the Routing Matrix, or an open Dialog Box. Two possible solutions are:</p> <p>Give focus to another view such as the Track View or Mixer before pressing the key, or</p> <p>Use an external MIDI control device such as a BCR2000 and assign transport functions to its various buttons. These will then work regardless of which window has focus, or whether a dialog box is open.</p>
<p>When I try to place the edit cursor exactly where I want it, it moves a little</p>	<p>Snapping may be enabled. If so, use the Options, Enable Snapping command to disable it.</p>
<p>When I try to make a time selection, the start and end points move from where I want them.</p>	<p>Snapping may be enabled. If so, use the Options, Enable Snapping command to disable it.</p>
<p>I add a Volume or Pan envelope to a track, but when I play back the fader does not move.</p>	<p>Make sure that Automation Mode is set to Read and the envelope is armed.</p>
<p>I record multiple takes on a track, but only the last one is visible.</p>	<p>To view all takes for a track, choose the Options, Show All Takes in Lanes Command,</p>

Interface Issues	
Problem	Diagnosis and Possible Solution
	<p><i>or</i></p> <p>To view a take other than the last take, right click over the media item and choose the Take command from the context menu.</p>
When I maximize a track, the wrong track is displayed	Check your <i>Vertical Zoom Behavior</i> settings under Options, Preferences, Editing Behavior. You probably want to set this to <i>Last Selected Track</i> .
When I zoom in horizontally, the edit cursor disappears from view and I lose my place	Check your <i>Horizontal Zoom Behavior</i> settings under Options, Preferences, Editing Behavior. You probably want to set this to <i>Edit Cursor or Play Cursor</i> .
I try to view a window, such as Big Clock or Performance Meter, but I can't see it on the screen	<p>This can be tricky, and can sometimes happen because of changes made to your Windows display settings. There are two main ways to fix this.</p> <p>Use Windows Notepad to edit the reaper.ini file in the folder C:\Documents and Settings\User Name\Applications Data\REAPER. This should only be attempted if you are confident that you understand what you are doing. For example, if the Big Clock has been lost, delete only that section of the reaper.ini file, save it, close it, then restart REAPER.</p> <p>For example, in the reaper.ini file extract shown here, the Big Clock section is shown as italicized:</p> <pre>[flac encoder defaults] default_size=12 default=63616C661000000005000000AB <i>[bigclock] wnd_vis=1 wnd_left=967 wnd_top=600 wnd_width=426 wnd_height=137 time_mode=0 [namecache] Analog_In_1_Delta_1010__1_=In 1</i></pre> <p>A safer option would be to simply rename this file as reaper.old or similar. This will return <i>all</i> preferences and options to their original default settings next time you run REAPER.</p>
My Undo History window is cluttered with every item and track selection I make	Go to Options, Preferences, General and disable <i>Create Undo points for item/track selection</i> .

25.3 Troubleshooting Record Modes and Monitoring

It can be difficult at first to understand how various permutations of REAPER's record modes (available from the Options menu) and monitoring options (from a track's arm record context menu) can be used together to obtain different results. I am indebted to **John Bercik** for supplying me with the information in summary form that is contained in the table below:

25 - Troubleshooting REAPER

Record Mode	Monitor Options	Behaviors
Normal	Monitor input ON Monitor track media when recording OFF	When stopped: monitors live material only When playing: monitors existing and live material continuously When recording: monitors live material only
	Monitor input (tape auto style) ON Monitor track media when recording OFF	Stopped: monitors live material Playing: monitors existing material only Recording: monitors existing and live material
	Monitor input ON Monitor track media when recording ON	Stopped: monitors live material Playing: monitors existing and live material continuously Recording: monitors existing and live outside punch, only live inside punch
	Monitor input (tape auto style) ON Monitor track media when recording ON	Stopped: monitors live material Playing: monitors existing material, then only live in punch Recording: monitors existing material, then only live in punch
Time Selection Auto Punch	Monitor input ON Monitor track media when recording OFF	Stopped: monitors live material Playing: monitors existing and live material continuously Recording: monitors existing and live outside punch, then only live material in punch
	Monitor input (tape auto style) ON Monitor track media when recording OFF	Stopped: monitors live material Playing: monitors existing material only Recording: monitors only existing material outside punch, then only live material in punch
	Monitor input ON Monitor track media when recording ON	Stopped: monitors live material Playing: monitors existing and live material continuously Recording: monitors existing and live outside and inside punch
	Monitor input (tape auto style) ON Monitor track media when recording ON	Stopped: monitors live material Playing: monitors only existing material Recording: monitors existing material outside punch, then existing and live inside punch
Auto Punch Selected Items	Monitor input ON Monitor track media when recording OFF	Stopped: monitors live material Playing: monitors existing and live material continuously Recording: monitors existing and live outside punch, then records and monitors live material in selected items
	Monitor input (tape auto style) ON Monitor track media when recording OFF	Stopped: monitors live material Playing: monitors existing material only Recording: monitors only existing material outside punch, then records and monitors live material in selected items
	Monitor input ON Monitor track media when recording ON	Stopped: monitors live material Playing: monitors existing and live material continuously Recording: monitors existing and live outside punch, then records and monitors live material in selected items
	Monitor input (tape auto style) ON Monitor track media when recording ON	Stopped: monitors live material Playing: monitors only existing material, then only live in punch Recording: monitors existing selected item(s), then records and monitors live material in selected items

Index

1		
14-bit CC messages.....	235	
14-bit MSB/LSB CC data.....	239	
A		
accidentals.....	280	
Action List.....	372	
Action List Editor.....	286	
Actions.....	285	
actions, meta actions.....	298	
Add FX.....	112, 446	
Add FX chain.....	447	
Add FX Chain.....	43	
Add Track.....	57	
Adjusting Track Height.....	38	
Advanced Disk I/O Options.....	422	
aggregate device (OS X).....	25	
AIFF.....	34	
Aliasing.....	25	
allow feedback.....	35	
amplifier simulator.....	326	
anguage packs.....	30	
Anticipative FX processing.....	116	
appearance preferences.....	424	
appearance settings.....	424	
Application Data Directory.....	29	
Apply FX to items as new take.....	441	
Apply track/take FX to items.....	160	
articulation.....	282	
ASIO Configuration.....	24, 420	
ASIO drivers.....	420	
ASIO Positioning Protocol.....	452	
ASIO4ALL.....	62	
ASIO4ALL (Windows).....	24	
associated project file.....	222	
Attach Docker.....	52	
Attack.....	320	
audio buffering.....	422	
Audio CD Image.....	405	
audio CD, burning.....	409	
audio CD, importing from.....	86	
audio clicks and pops.....	419	
Audio device.....	24	
Audio Device.....	24, 419, 420	
Audio Device, enabling.....	456	
audio dropouts.....	419	
Audio Ducking.....	338	
audio format, converting.....	78	
Audio Hardware Outputs.....	50	
Audio Hardware Setup.....	455	
Audio inputs.....	24	
Audio Output.....	35	
Audio outputs.....	24	
audio preferences.....	421	
Audio Preferences.....	26	
Audio Problems.....	455	
audio seek settings.....	423	
audio settings.....	421	
Audio setup.....	24	
audio stream.....	420	
Audio System.....	24	
auto name tracks.....	89	
auto punch.....	63	
auto punch recording.....	68	
auto trim/split items.....	153	
auto-save.....	417	
autocrossfade mouse modifiers.....	142	
Automatic record arm.....	59	
Automating Automation.....	372	
Automating FX Parameters on the Fly.....	371	
Automation.....	381, 382	
automation envelopes.....	353	
automation lanes, hiding.....	362	
Automation Latch.....	357	
Automation Methods.....	353	
automation mode, set default.....	418	
Automation Modes.....	356, 357	
Automation Read.....	355, 357	
automation settings.....	430	
Automation Write.....	355, 358	
automation, hardware output sends.....	372	
Automation, Mute/Unmute.....	357	
Automation, Trim/Read.....	357	
Automation, writing.....	354	
autosave.....	55	
Auxiliary Input.....	338	
B		
backup.....	417, 437	
backup, automatic.....	55	
Bass.....	312	
batch file converter.....	401	
batch rendering.....	406	
beat correction.....	173	
beat detection.....	173	
Big Clock.....	37	
buffer size.....	419	
buffer size, increasing.....	456	
buffers.....	419	
Burn Audio CD.....	411	
Burn Audio CD Image.....	411	
burn to CD.....	405	
Bus.....	44	
Bus track.....	95	
Bus, creating.....	45	
Bypass an FX.....	42	
C		
CC Lane.....	234	
CC lane management.....	255	
CC lane, context menu.....	234	
CC lane, marquee selection.....	234	
CC lanes, resizing.....	235	
CD Audio.....	405	
CD audio, importing from.....	86	
CD burning.....	405	
CD Image.....	405	
Center Transport Controls.....	446	
Change rhythm pattern.....	276	
Change tempo.....	276	
Change time signature.....	276	
Channel Mixer.....	342	
channel routing plug-ins.....	344	
channel splitting.....	201, 332	
Channel Splitting.....	180, 336	
channel switching utility.....	344	
channels.....	337	
chord notation.....	283	
chorus.....	326	
chromatic MIDI item, creating.....	177	
chromatic midi, using.....	177	
Clean Current Project Directory.....	436	
Clear envelope.....	445	
clef.....	274	
Click Source, inserting.....	373	
clicks, pops, stutters.....	456	
clipping.....	456	
Close FX window.....	447	
color, customizing.....	206	
color, set tracks to custom.....	90	
color, set tracks to random.....	90	
colors, order of precedence.....	161	
colour themes.....	91	
Commands.....	21	
comp management.....	443	
comp sets, recalling.....	157	
comp sets, saving.....	157	
Compression.....	318	
compression, dynamic.....	381	
compressor, digital drums.....	326	
configuration, export.....	416	
configuration, import.....	416	
configurations, export.....	415	
Consolidating a project.....	402	
Context Menus.....	21	
continuous scroll.....	33, 423	
continuous scrolling.....	438	
control change messages.....	231	
Control Channel Editing.....	232	
control surface.....	219	
Control Surface, installing.....	27	
control surface, setting up.....	296	
control surface, using.....	296	
Controlled Bleed.....	331	
Controls.....	21	
Copy Items.....	125	
Copy loop of selected area of items.....	440, 441	
Copy selected area of selected items.....	440, 441	
Copy selected envelope points.....	444	
Copy selected FX.....	447	
Copy selected items.....	441	

FX presets, exporting.....315
FX presets, importing.....315
FX presets, using.....315
FX processing.....422
FX Processing Plug-ins.....20
FX Remove.....43
FX replace.....113
FX Save Chain.....43
FX Save Chain as default.....42
FX wah.....326
FX wet/dry mix.....42
FX Window.....455
FX window open.....114
FX, changing name.....115
FX, default settings.....115
FX, drag and drop.....121
FX, filtering.....112
FX, parallel processing.....342
FX, per item.....129
FX, recently used.....113
FX, rename instance.....115

G

Gain.....318
global automation override.....359
Glue.....144
Glue selected item.....163
Glue selected items.....145, 441
Glue Selected Items.....156
goniometer.....327
grace note.....282
Grid actions.....255
grid lines.....94
grid settings.....94
Grid settings.....128
grid snap spacing.....128
grid, set to frame.....94
Group.....441
Group controls: Master only.....101
Group controls: Master/Slave.....101
Group controls: Slave only.....101
group mode, automation.....367
grouped parameters, automation.....367
Grouping.....143
grouping items.....143
Grouping Matrix.....100, 101
Guitar FX Plug-ins.....326

H

hardware outputs, specifying.....200
harmonies, creating.....180
Headphone bleed.....331
headphone mix.....62
headphone mix, creating.....93
Headphone Monitoring.....92
Heal Split Items.....125
Hide Transport.....446
high pass filter.....328
High Range.....313
hiss removal.....321
Hold.....320

Horizontal Scroll.....39
Horizontal Zoom.....39
Humanize notes.....238
Humanize Notes.....248

I

I/O Button.....50
image file.....405
implode items.....147
import audio from CD.....86
imported media file formats.....86
importing a project file.....61
Importing Media.....79
In-Line MIDI Editing.....256
individual items, locking.....204
Input Aliasing.....25
input assignment.....57
input monitoring.....419
Input Monitoring.....62, 69, 73
Input Quantize.....247
Input, Auxilliary.....338
Input, Main.....338
inputs, sequential.....59
Insert empty space at selection.....440
Insert marker.....440
insert multiple tracks.....58
Insert note.....241
Insert time signature marker.....440
Insert track.....439
Insert, Empty space in selection.....147
Inserting Track FX.....40
Install Directory.....29
install REAPER OS X.....19
Install REAPER to USB key.21, 31, 32
install REAPER, Windows.....19
Installed Folders.....28
Interface Issues.....457
internet audio, recording.....77
Invert selected points.....445
Item Channel Mode.....135
item colours.....134
Item FX, managing.....130
Item Grouping.....143
Item mix behavior.....35
Item Notes.....133
Item Properties.....132, 455
Item Properties.....441, 442, 443
item selection sets.....216
Item Settings.....441, 442, 443
Item Timebase.....132
Item volume handle.....134
Item volume k.....134
Item volume knob.....134
item, move.....126
item, nudge.....126
item, slide.....126
Items, locking.....205

J

Jesasonic FX.....40
Jogging.....109

jogging, looped segment mode.....109
joystick MIDI device, installing.....27
Jump To.....49
Jump to Marker.....445, 446

K

key signature.....276
keyboard assignment, changing.....290
keyboard settings.....417
keyboard shortcut, assigning multiple actions.....293
keyboard shortcut, changing.....290
keyboard shortcut, creating.....289
keyboard shortcut, removing.....290
keyboard shortcuts.....213, 291
Keyboard Shortcuts.....21
keyboard shortcuts, assigning to a control surface.....296
Keyboard Shortcuts, customizing.....285
keyboard shortcuts, exporting.....293
keyboard shortcuts, for media explorer.....292
keyboard shortcuts, for MIDI editor.....292
keyboard shortcuts, for recording.....291
keyboard shortcuts, importing.....293
keyboard shortcuts, sections.....291
keyboard shortcuts, show list.....39
Keyboard, Virtual.....70
keymap sets, exporting.....293
keymap sets, importing.....293

L

lame_enc.dll.....403
Lanes.....65
lanes, automation.....353
language packs.....415
Latch.....357
latch preview.....357, 358
latency.....62, 419, 422, 456
Layered Recording.....62
Layouts.....217
Layouts. Mixer.....217
Layouts. Track.....217
Limiter.....314
Linear Time Code.....452
Linear/longitudinal time code.....453
Link track volume/pan to MIDI 88, 227
Live Output.....411
Lock Settings.....205
Locking.....205
Locking Items.....205
Locking media items.....204
Locking track controls.....204
Loop overdubbing.....63, 72
loop points.....127
loop points, link to time selection.....127
loop selection.....63
Loop Selection, locking.....205
Loop Selection, managing.....48
loop selection, modifying.....48

Up and Running: A REAPER User Guide v 5.24

Loop, creating.....	163	Menus, customizing.....	285, 303	MIDI source data pool.....	258
Looped points linked to time selection	48	menus, exporting.....	304	MIDI time code.....	453
looped time selection recording. 63, 72		menus, importing.....	304	MIDI Time Code.....	452
Looping.....	163	meta actions.....	298	MIDI touch-replace.....	71
Loops.....	47	Meta actions.....	298	MIDI Track List.....	251, 252
low pass filter.....	328	metadata.....	80	MIDI track not playing.....	456
LTC.....	452, 453	Metronome.....	59	MIDI Track Selector.....	251
Lyric events.....	256	Metronome Enabled.....	59	MIDI_Router.....	261
		metronome output.....	59	midi_transpose.....	261
		Metronome Settings.....	59	MIDI_Velocifier.....	261
		Metronome, automating.....	373	MIDI_chase note-ons.....	238
		Mid Range.....	312	MIDI, export to file.....	259
		MIDI.....		MIDI, sync transport to project.....	238
		event properties.....	136	Mixer.....	187
		Tempo Map.....	373	Mixer Appearance.....	197
		Event List View.....	244	Mixer Colour Themes.....	197
		Named Notes View.....	244	mixer layout options.....	187
		Piano Roll View.....	244	mixer layouts.....	194
		MIDI actions.....	254, 255	Mixer layouts.....	187
		MIDI buses.....	259	Mixer preferences.....	197
		MIDI data, exporting.....	258	mixer, managing FX.....	189
		MIDI data: 14 bit.....	245	mixer, managing sends.....	192
		MIDI Device, installing.....	26	mixer, on-screen adjustments.....	193
		MIDI Devices.....	26, 72	Mixing Down.....	401
		MIDI editing, in-line.....	227	Monitor external synth.....	227
		MIDI Editor.....	228, 236	Monitor Input.....	69
		CC Lane.....	234	Monitor Input	443
		MIDI Editor Modes.....	244	Monitor Input (Tape Auto Style).....	62
		MIDI editor settings.....	432	Monitor track media when recording	63
		MIDI Editor window.....	227	monitoring options.....	458
		MIDI Editor, creating notes.....	241	Monkey's Audio.....	402
		MIDI editor, manage tracks.....	212	mordent.....	282
		MIDI Files, importing.....	84	mouse behavior preferences.....	431
		MIDI Filter Events window.....	252	mouse modifier settings, save/restore	301
		MIDI filters.....	229	mouse modifiers 39, 90, 126, 142, 145, 149, 150, 188, 228, 285, 299, 302, 361	
		MIDI Hardware Device.....	456	mouse modifiers, changing. . .	140, 299, 361
		MIDI Hardware Output.....	50	Mouse Modifiers, customizing.....	285
		MIDI input device.....	69	mouse modifiers, in MIDI editor...	301
		MIDI input with sequential channels	71	mouse modifiers, show list.....	39
		MIDI Item.....	70	mouse settings.....	431
		MIDI item, creating.....	228	Mouse, customizing behavior.....	431
		MIDI items, smart editing.....	236	Mousewheel.....	39
		MIDI items, time selection.....	236	mousewheel assignments.....	293
		MIDI key mapping.....	261	Move all media into project directory	56
		MIDI latch-replace.....	71	MP3.....	34
		MIDI loop recording.....	424	MP3 format.....	405
		MIDI Media Item Lane.....	251, 253	MSB.....	245
		MIDI Media Item Selector.....	251	MSB/LSB CC data.....	245
		MIDI Note preview.....	239	MTC.....	453
		MIDI octave name display offset...	261	Multiband Compression.....	322
		MIDI Output device, time offset.....	26	multichannel format.....	405
		MIDI overdub.....	71	multichannel recording.....	60
		MIDI plug-ins.....	260	multichannel tracks.....	60
		MIDI preferences.....	258, 434	multichannel VU meters.....	60, 104
		MIDI Recording.....	69	multiple audio outputs.....	25
		MIDI replace.....	71	multiple channels.....	332
		MIDI routing.....	259	multiple instances, allowing.....	415
		MIDI scrub.....	243		
		MIDI sends and receives.....	227		
		MIDI sends/receives.....	260		
		MIDI Setup.....	26		
		MIDI snap settings.....	238		

- sidechaining.....338, 339, 375
silent passages, removing.....151
skip time selection.....49
slave REAPER to sequencer.....453
Slip Editing.....139
slur.....282
smart FX folder.....111
smart tools.....309
smooth seek.....423
SMPTE.....452, 453
SMPTE timecode generator.....453
Snap Distance.....128
Snap offset.....132
Snap to Grid.....128
snap to marker.....165
Snap/Grid Settings.....128
software synthesizer.....456
Software Updates.....21
Solo.....37
Solo Defeat.....88
Solo In Front.....89
Song Position Pointer.....452
sound card.....419
Sound Card Settings.....455
Sound Shaping.....311
Sound Shaping Plug-ins.....312
Source Media Bay.....209
Source Properties.....136
Source Properties.....441, 442, 443
Split Events.....237, 241
Split Items.....125
Split items at cursor.....440, 442
Split items at time selection.....440, 442
Split Items, Heal.....125
Splitting Channels.....332
SPP.....452
SPP Send.....452
staff notation.....267
Start Menu Shortcuts.....20
start time, marking.....203
start time, setting.....203
Starting REAPER.....21
startup options.....415
Stem Rendering.....117
step recording.....239, 250
Step Sequencer.....239
stereo enhancer.....327
Stereo to Mono conversion.....135
stereo track, recording.....60
Stereo, reversing.....135
Stretch markers.....184
submix, rendering.....118
subprojects.....222, 223, 224, 225, 226
subprojects.....222
Surround panner.....350
SWS Extensions.....153
Sync piano roll view to project.....263
sync to external device.....452
synchronize external device to
 REAPER.....453
Synchronous FX multiprocessing.....116
Synthesizer.....70
SysEx messages.....233
System tweaks.....436
- T**
- Take.....441
Take command.....66
Take, next.....66
Take, previous.....66
takes, arranging.....155
takes, color coded.....65
takes, editing.....155
takes, envelopes.....371
takes, explode in place.....156
takes, explode to tracks.....155
Takes, Explode to tracks.....66
takes, imploding.....159, 160
takes, propagating.....162
Takes, Showing Lanes.....65
Takes, Slice and Dice.....157
TCP settings.....427
template.....417
Template, Project.....61
template, set default.....417
Template, Track.....61
Tempo Change.....186
tempo changes.....186
tempo detection.....173
Tempo Map Envelope.....373
Text Events.....233
The Install Options.....20
the Microsoft GS Wavetable Synth.....72
theme, modifying.....206
Threshold.....318, 320
Time Based Effects.....313
time selection.....127
time selection recording.....63
time selection recording, looped.....72
time selection, in media explorer.....81
Time Selection, keyboard shortcuts.....48
time selection, link to loop points.....127
time selection, modifying.....49
time signature changes.....186
Time Signature Marker.....186
time signature marker, inserting.....177
time stretch.....132
Time Stretching.....183
Time-Based Effects.....311
timebase.....34
timecode, inserting.....453
TimeDifference Pan.....324
Timeline.....47
timeline: set units.....48
Toggle selected bypass.....447
Toggle selected offline.....447
tonifier.....327
toolbar.....110
Toolbar.....22
toolbar docker.....310
toolbar, custom.....39, 305
toolbar, custom envelope.....366
Toolbars.....21
toolbars, custom.....308
- Toolbars, customizing.....285
toolbars, exporting.....307
toolbars, floating.....308
toolbars, importing.....307
Touch.....357
Track Channels.....345
track color.....212
track color options.....90
Track Control Modifiers.....88
Track Control Pane.....41
track control panel help.....220
track controls.....23, 219
Track Controls.....37
Track Controls, locking.....204
Track default settings.....418
Track FX.....40, 111
Track FX Order.....42
Track FX parameters.....42
Track FX, copying.....113
track grouping.....99, 100
track grouping controls.....104
track layouts.....92
Track Manager.....119, 211
track pan, using for MIDI.....37
Track Panel Width.....38
Track Panels.....23
Track Performance Options.....116
Track Routing.....50
Track Template, Inserting.....61
track templates.....120, 220, 365
Track Templates.....61
Track View screen sets.....213
Track Views.....213
track volume, using for MIDI.....37
Track volume/pan, link to MIDI.....88
Track, Add New Track.....45
Track, copy.....87
Track, delete.....87
Track, move.....87
Track/Send Defaults.....418
tracks, freeze/unfreeze.....118
transient detection sensitivity.....153
transient detection settings.....173, 428
transient guides.....184
transient, extend selection to.....173
transient, move cursor to next.....173
transients.....172
transients guides.....152
Transients Killer.....319
Transport.....445
Transport Bar.....36
Transport Bar, dock/undock.....36
Transport Control.....457
transpose MIDI.....238, 254
transpose MIDI notes.....243, 254, 256
tremelo.....326
trill.....282
Trim content behind media items.....129
Trim items to selected area.....441
Trim Items to Selected Area.....148
tuner.....327
tuning an instrument.....181

